

Linear ceiling diffuser

Type LDD / LDDL

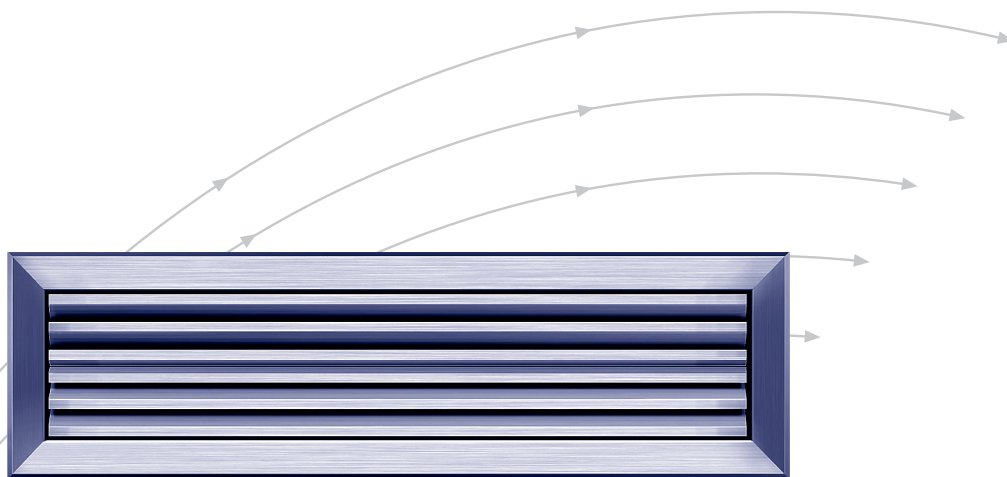

TROX[®] TECHNIK



The art of handling air

TROX HESCO Schweiz AG
Walderstrasse 125
Postfach 455
CH-8630 Rüti ZH

Tel. +41 55 250 71 11
Fax +41 55 250 73 10
www.troxhesco.ch
info@troxhesco.ch

Contents · Realisation · Application · Safety instructions

Contents

Realisation · Application · Safety instructions	2
Dimensions	3
Dimensions · Installation · Quick selection	4
Technical Data	5–11
Order details	12

Realisation

The linear ceiling diffusers consist of an angular frame with glued-on foam gasket. The removable blade grating is available with one or two-sided discharge.

Material

Variante 1

Frame and blades of steel profiles, color powder-coated RAL 9010, matt 25% brilliance

Variante 2

Frame and blades of light metal sections, anodized colourless finish

Holding springs of stainless steel

Fully concealed attachment

On request, the diffusers are supplied with flow-rate control devices (opposed blade damper, flap casing or plenum box).

Application

The linear ceiling diffusers with one or two-sided discharge are especially suitable for air supply through ceilings. They distribute the air along the ceiling and can be used in very low rooms.

The linear ceiling diffusers feature excellent induction. Mixing of the air jets with the room air and thus the heat exchange begin in the immediate neighbourhood of the diffuser.

Therefore, warmer and particularly colder air can be supplied without draft effects.

The linear ceiling diffusers with removable blade grating provide easy mounting. They look very attractive and warrant for optimum discharge conditions.

E = insufflation unilatérale **Z** = two-sided discharge

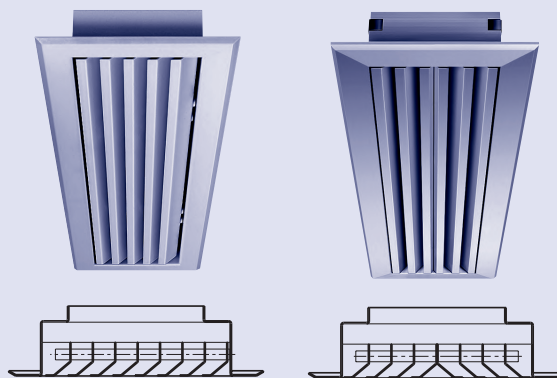

Safety instructions

CAUTION!

Risk of injury from sharp edges and corners, ridges and thin-walled sheet metal parts!

- Proceed carefully with all work.
- Wear protective gloves, safety shoes and protective helmet.

WARNING!

Danger from incorrect use. Misuse of the product may lead to dangerous situations.

The product must not be used:

- in areas subject to explosion hazards;
- in the open air without sufficient protection against weather effects;
- in atmospheres that may have a damaging and/or corrosive effect on the product due to scheduled or unscheduled chemical reactions.

CAUTION!

Damage to the product due to improper handling. Check the device for damage and contamination prior to operation!

Improper handling may lead to considerable material damage of the product.

- Do not use any acid or abrasive cleaning agents.
- Adhesives from sticky tape may lead to colour damage.
- Excessive moisture may lead to colour damage and corrosion.
- Use only cleaning agents, greases and oils that are expressly specified.

Single grilles LDD / LDD L

1) Recess

Nominal dimension

B = Nominal width
H = Nominal height } = inner dimensions of frame from behind

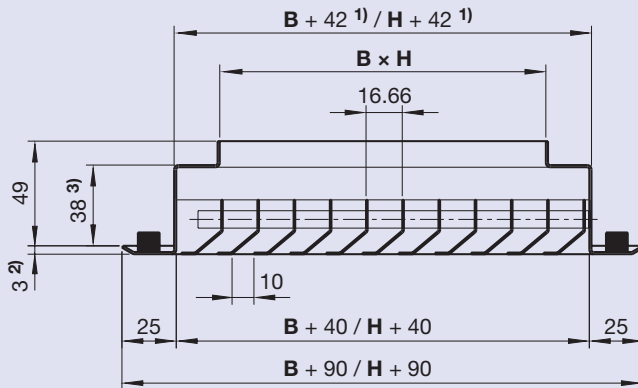
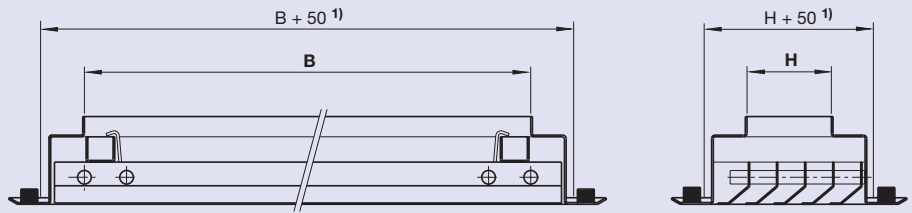

- 1) for realisation in light metal: B + 45, H + 45 (corner springs)
- 2) for realisation in light metal: 3.5 mm
- 3) for realisation in light metal: 39 mm

Quantity of slots						
Nom. dimens. H [mm]	50	100	150	200	250	300
one-sided E	4	7	10	13	16	19
two sided Z	4	6	10	12	16	18

LDD E(Z)5

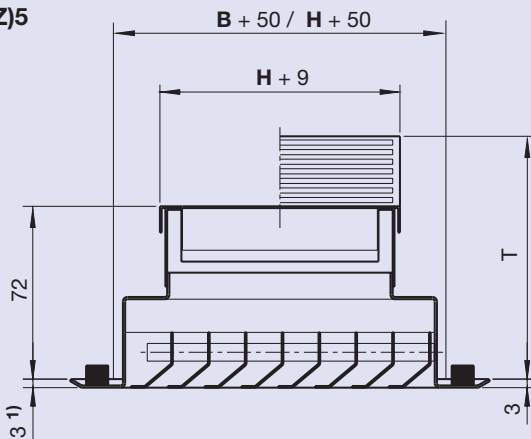

LDD E(Z)6

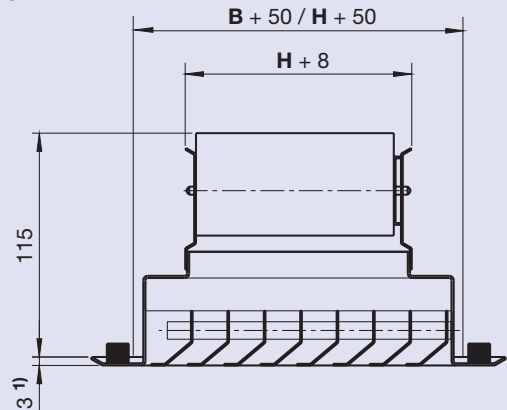

1) for realisation in light metal: 3.5 mm

B [mm]	400	500	600	750	900
T [mm]	105	115	125	135	148

Individual grilles LDD - E 5 (LDD LE 5) or LDD - Z 5 (LDD LZ 5) up to a length B of 900 mm are supplied with **inclined** flap casing.

If the length B exceeds 900 mm, a **parallel** flap casing is always supplied.

LDD and LDD L - linear air terminals

The term 'linear air terminal' refers to LDD or LDD L with a nominal dimension B which exceeds 2000 mm, lengths exceeding 2000 mm are supplied as partial segments.

The dimension B must be divisible by 250 mm.

Nominal dimension H see individual grilles.

Special model

If supply air plenum boxes (pressure boxes) are used, **parallel** flap casings are supplied for **all** lengths B. Name 5P.

Supply air plenum boxes see prospect L-04-2-03e.

Dimensions · Installation · Quick selection

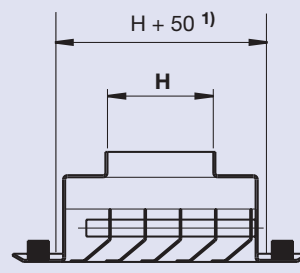
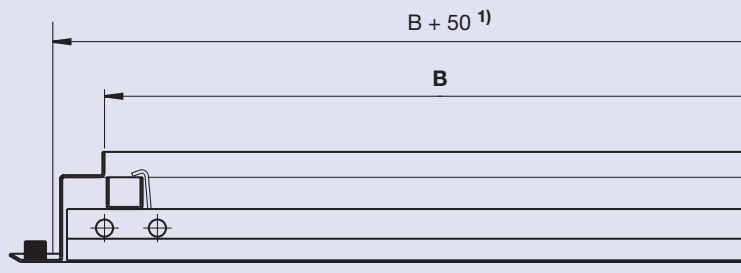

1) = Recess
B, H = Nominal width, nominal height

Installation
 see installation description L-04-2-03e

Definitions

B, H	m	Nominal width, Nominal height
\dot{V}	m ³ /h	Air flow rate
\dot{V}/m^2	m ³ /h/m	Air flow rate per m ²
R _T	m	Room depth
R _H	m	Room height
v _{eff}	m/s	Eff. discharge velocity (Basis for the values of the table: 2.7 m/s)
Δp _s	Pa	Static pressure drop
Δp _t	Pa	Total pressure drop
L _{WA}	dB(A)	A-weighted sound power level
L _w	dB	Linear sound power level
P	W	Cooling capacity
L _{0.5}	m	Distance in relation to the final velocities 0.5 m/s

Example given

Linear ceiling diffuser	B × H	LDD E6 100% open	900×100 mm
Air flow rate	\dot{V}		300 m ³ /h
Eff. discharge velocity	v _{eff}		2.7 m/s
Room depth	R _T		ca. 7.5 m
Static pressure drop	Δp _s		4.5 Pa
Sound power level for other nom. dimensions consider the correction values (plus or minus-values)	L _w		30 dB(A)
Air flow rate	\dot{V}/m^2		ca. 24 m ³ /h, m ²
P/m ²			ca. 76 W/m ² (at ΔT = -10 K)
min. distance «middle to middle linear ceiling diffuser» (in B-direction)	A _m		B + (R _T * 0.1)
Free section of blade grating			35%

Sizes of single grilles / Quick selection ¹⁾

H [mm]	B [mm]									\dot{V} / m [m ³ /h] [l/s]	R _T ca. [m]	min. R _H T = -10K ca. [m]
	400	500	600	750	900	1250	1500	1750	2000			
	[m ³ /h] [l/s]	[m ³ /h] [l/s]	[m ³ /h] [l/s]	[m ³ /h] [l/s]	[m ³ /h] [l/s]	[m ³ /h] [l/s]	[m ³ /h] [l/s]	[m ³ /h] [l/s]	[m ³ /h] [l/s]			
50	67	84	100	125	150	208	250	293	333	167	4.0 ⁴⁾ 5.0 ⁵⁾	2.4
	18.6	23.3	27.8	34.7	41.7	57.8	69.4	81.4	92.5			
100	133	167	200	250	300	416	500	583	666	333	7.5 ⁴⁾ 9.0 ⁵⁾	2.6
	37.2	46.7	55.6	69.4	83.3	116	139	163	185			
150			300	375	450	624	750	875	1000	500	11 ⁴⁾ 13 ⁵⁾	3
			83.3	104	125	173	208	244	278			
200 ³⁾				500	600	832	1000	1166	1332	666		
				139	167	231	278	326	370			
250 ³⁾				625	750	1040	1250	1458	1666	833		
				174	208	189	347	407	463			
300 ²⁾ ³⁾				750	900	1250	1500	1750	2000	1000		
				208	250	347	417	488	555			

- 1) For supply air the ceiling must be flat. (Coandaeffect)
- 2) For linear diffusers with nominal dimensions H = 300 mm flap casings are not available (type 5 or 5P). Choice type D6 / opposed blade damper.
- 3) The nominal height H > 150 mm are not applicable für supply air with high requirements to the comfort and big cooling charges
- 4) Room depth of LDD...-individual grilles, nominal width B = 900 mm
- 5) Room depth of LDD...-linear air terminals

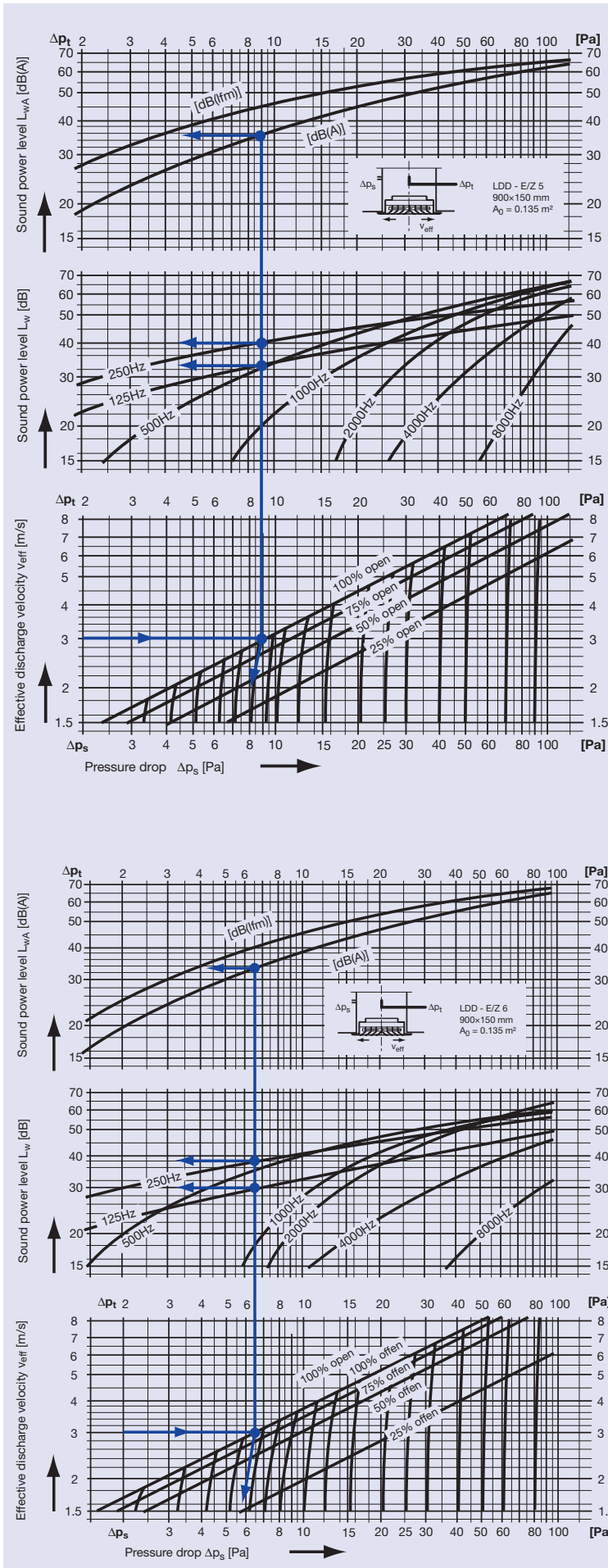

Sound power level LDD 5, one- and two-sided discharge, supply air without plenum box

Sound power level L_{WA} and pressure drop Δp_t ; Δp_s , LDD E/Z 5, B x H = 900x150 mm,

Tolerances: total level ± 2 dB, octave level ± 4 dB; nom. surface of reference $A_0 = 0.135 \text{ m}^2$; sound power level of reference $W_0 = 10^{-12} \text{ W}$

Example

LDD E/Z 5, B x H = 900 x 100 mm; $v_{eff} = 3 \text{ m/s}$
Diagram $\rightarrow L_{WA 0.135} = 35 \text{ dB(A)}$
 $L_{w0.135; 125\text{Hz}} = 33 \text{ dB}$; $L_{w0.135; 250\text{Hz}} = 40 \text{ dB a.s.o.}$

Correction ΔL_w from table $\Delta L_w 900 \times 100 = \sim 1 \text{ dB}$

$L_{WA 0.09} = 34 \text{ dB(A)}$

$L_{w0.09; 125\text{Hz}} = 32 \text{ dB}$; $L_{w 0.09; 250\text{Hz}} = 39 \text{ dB a.s.o.}$

ND	...x50	...x100	...x150	...x200	...x250	...x300
	Correction «diffuser dimension» ΔL_w [dB]					
400x...	-4	-2				
500x...	-4	-2				
600x...	-3	-2	-1			
750x...	-3	-1	0	0	+1	+1
900x...	-2	-1	0	+1	+1	+1
1250x...	-2	0	+1	+1	+2	+2
1500x...	-1	0	+1	+2	+2	+2
1750x...	-1	+1	+1	+2	+2	+3
2000x...	-1	+1	+2	+2	+3	+3

Sound power level LDD 6, one- and two-sided discharge, supply air without plenum box

Sound power level L_{WA} and pressure drop Δp_t ; Δp_s , LDD E/Z 6, B x H = 900x150 mm,

Tolerances: total level ± 2 dB, octave level ± 4 dB; nom. surface of reference $A_0 = 0.135 \text{ m}^2$; sound power level of reference $W_0 = 10^{-12} \text{ W}$

Example

LDD E/Z 6, B x H = 900 x 100 mm; $v_{eff} = 3 \text{ m/s}$
Diagram $\rightarrow L_{WA 0.135} = 33 \text{ dB(A)}$
 $L_{w0.135; 125\text{Hz}} = 30 \text{ dB}$; $L_{w0.135; 250\text{Hz}} = 38 \text{ dB usw.}$

Correction ΔL_w from table $\Delta L_w 900 \times 100 = \sim 1 \text{ dB}$

$L_{WA 0.09} = 32 \text{ dB(A)}$

$L_{w0.09; 125\text{Hz}} = 29 \text{ dB}$; $L_{w0.09; 250\text{Hz}} = 37 \text{ dB usw.}$

ND	...x50	...x100	...x150	...x200	...x250	...x300
	Correction «diffuser dimension» ΔL_w [dB]					
400x...	-4	-2				
500x...	-4	-2				
600x...	-3	-2	-1			
750x...	-3	-1	0	0	+1	+1
900x...	-2	-1	0	+1	+1	+1
1250x...	-2	0	+1	+1	+2	+2
1500x...	-1	0	+1	+2	+2	+2
1750x...	-1	+1	+1	+2	+2	+3
2000x...	-1	+1	+2	+2	+3	+3

Technical Data

Linear ceiling diffusers – one-sided discharge

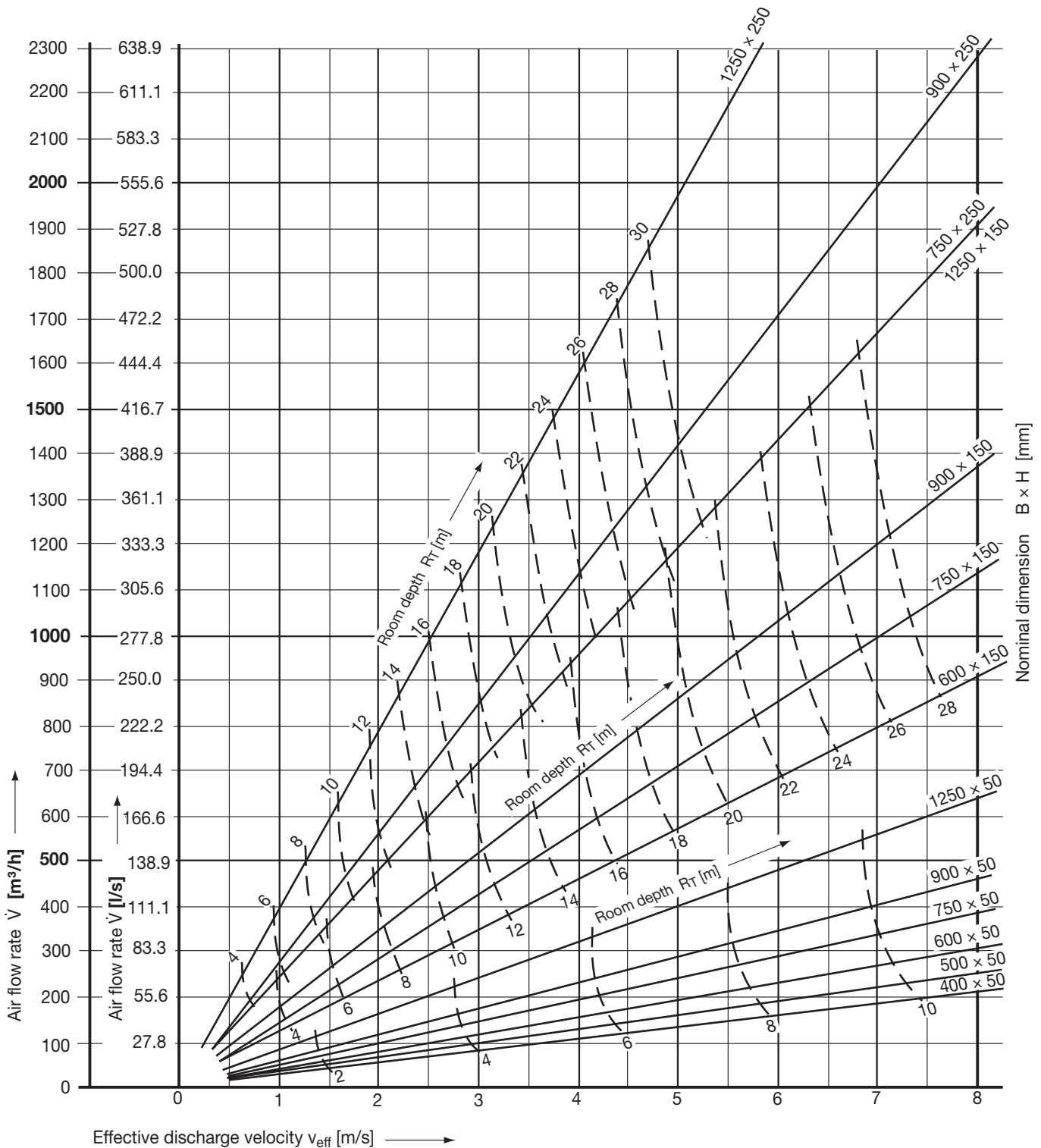
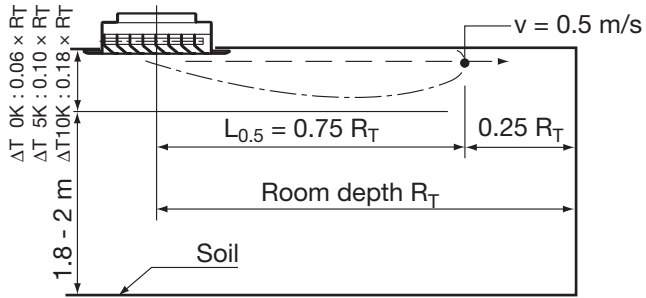

Linear ceiling diffusers – one-sided discharge

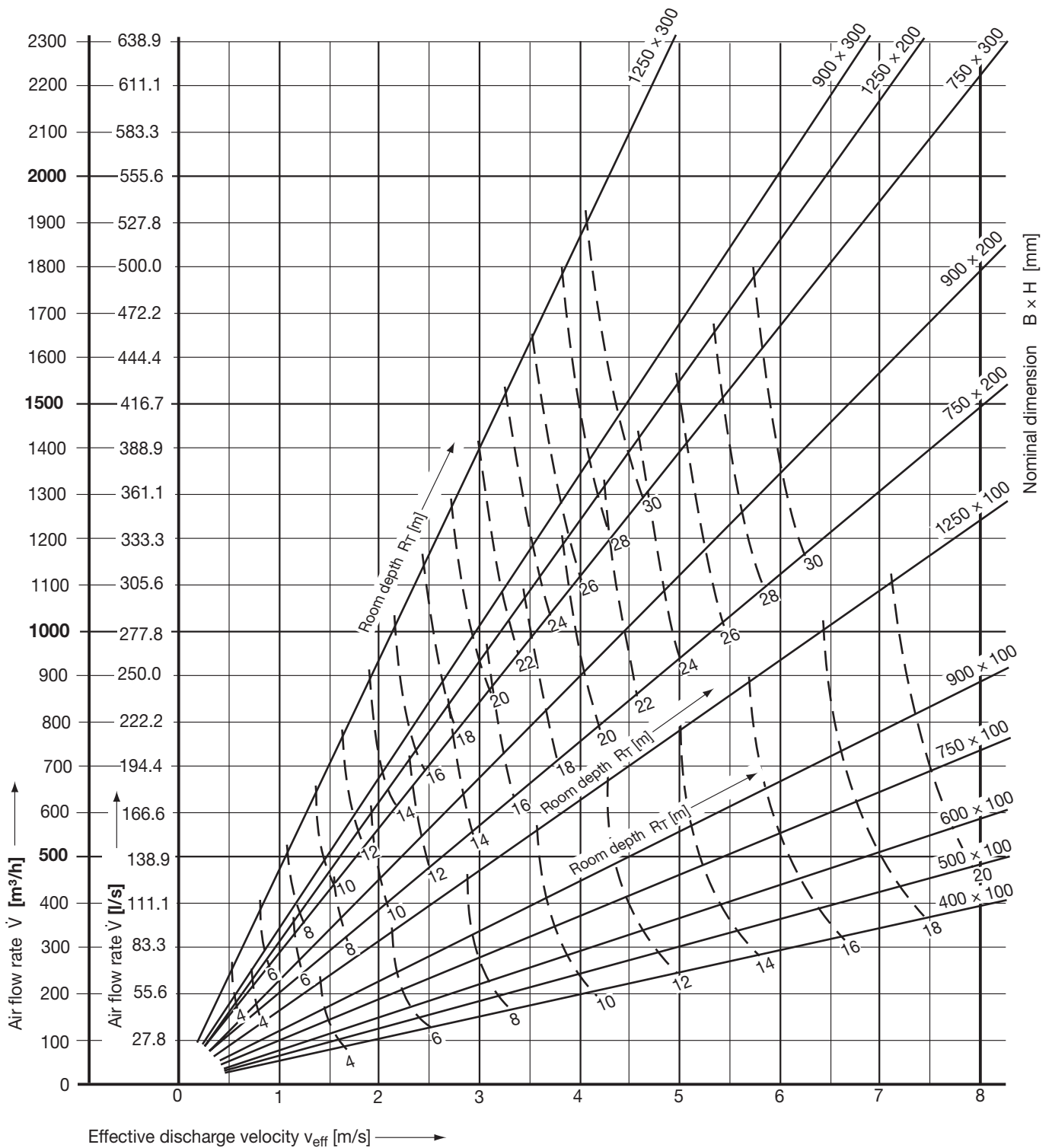
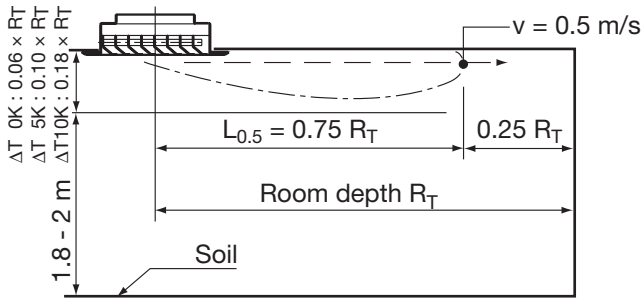

Technical Data

Linear ceiling diffusers – two-sided discharge

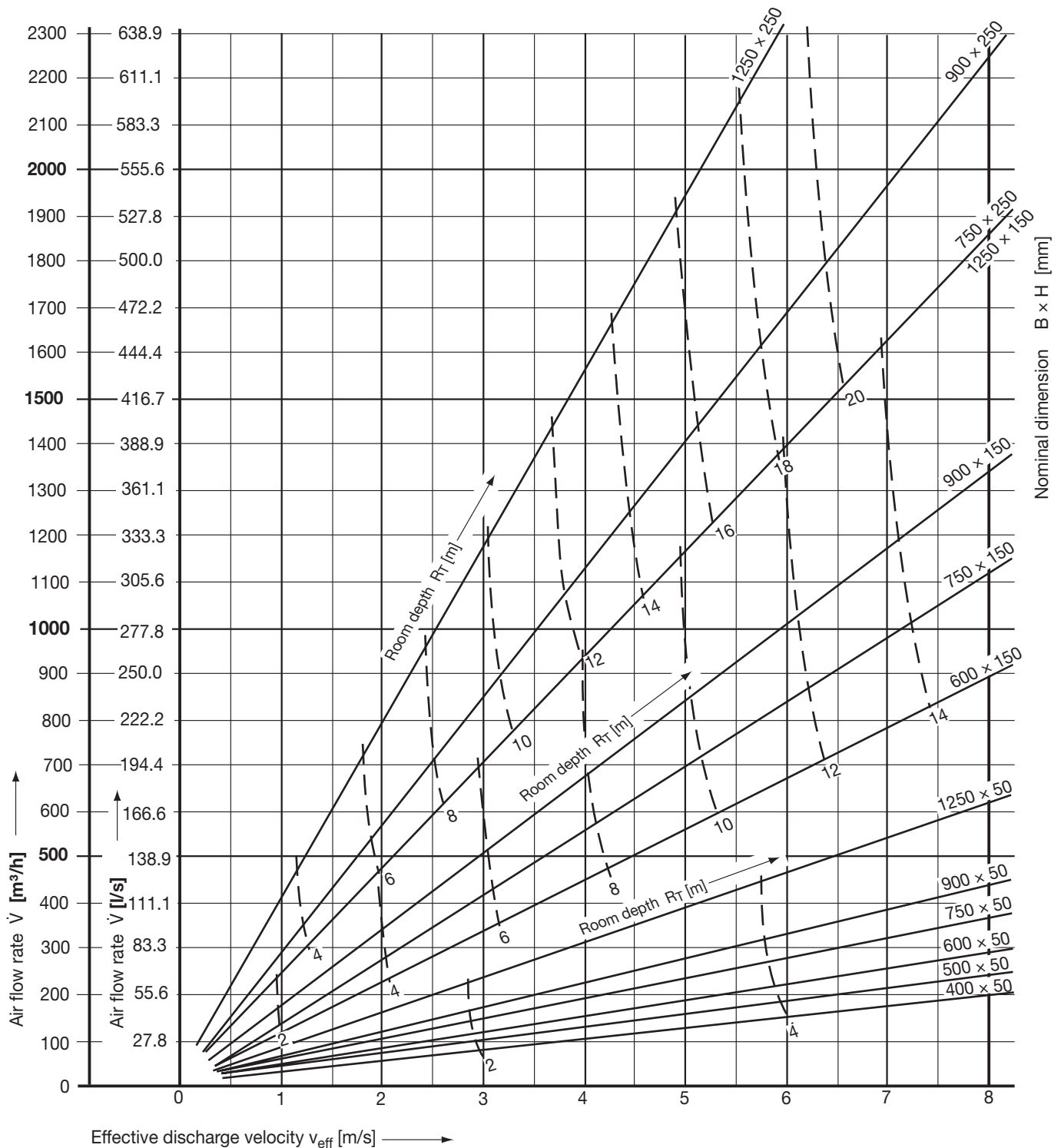
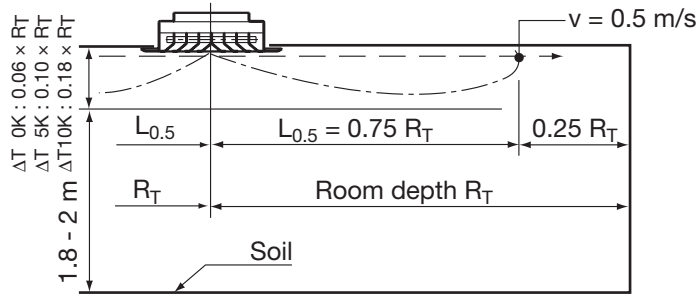

Linear ceiling diffusers – two-sided discharge

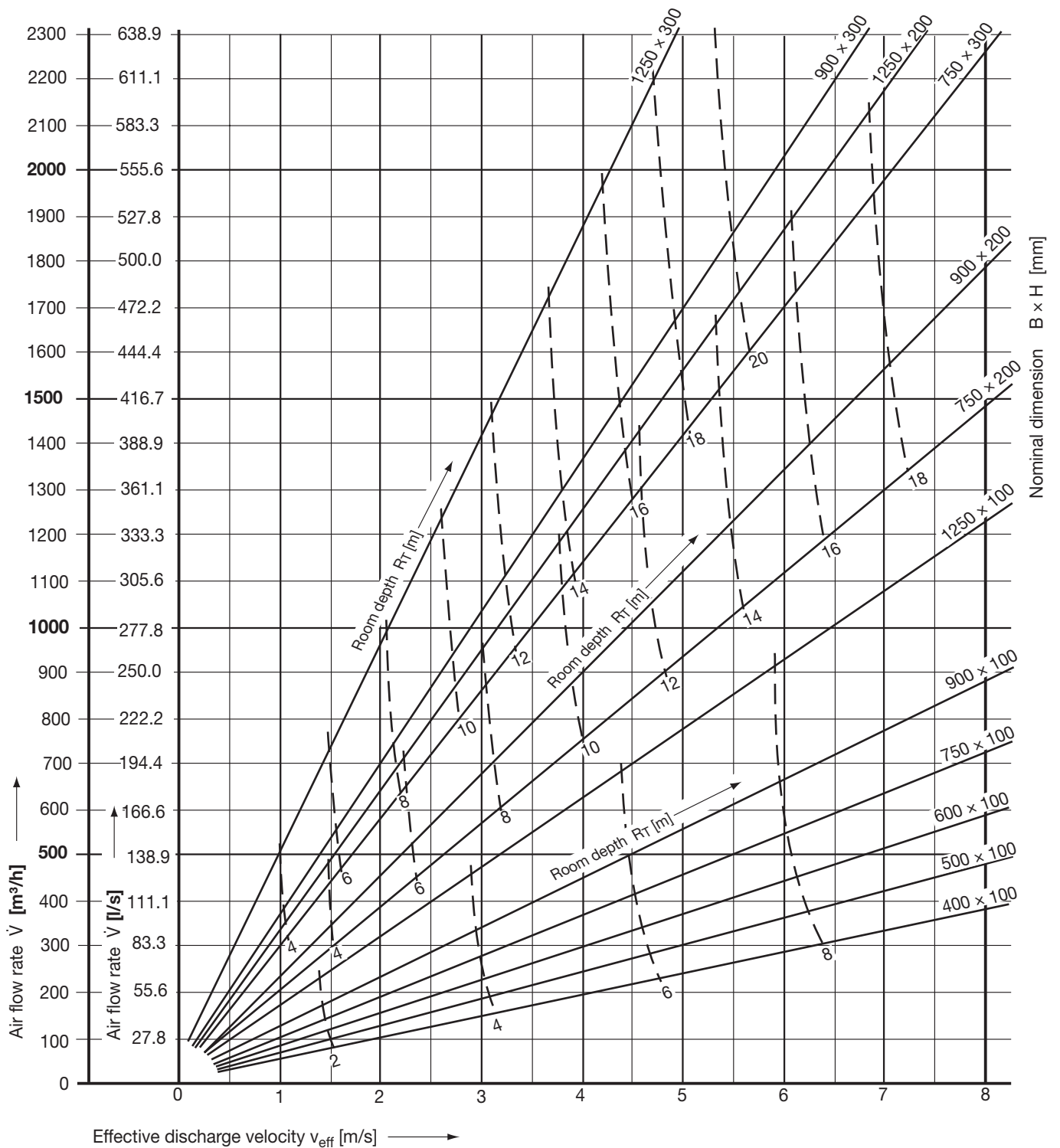
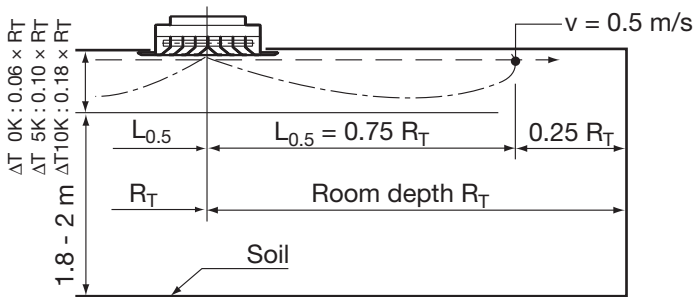

Technical Data

Linear ceiling diffusers – 'linear air terminal – one-sided discharge

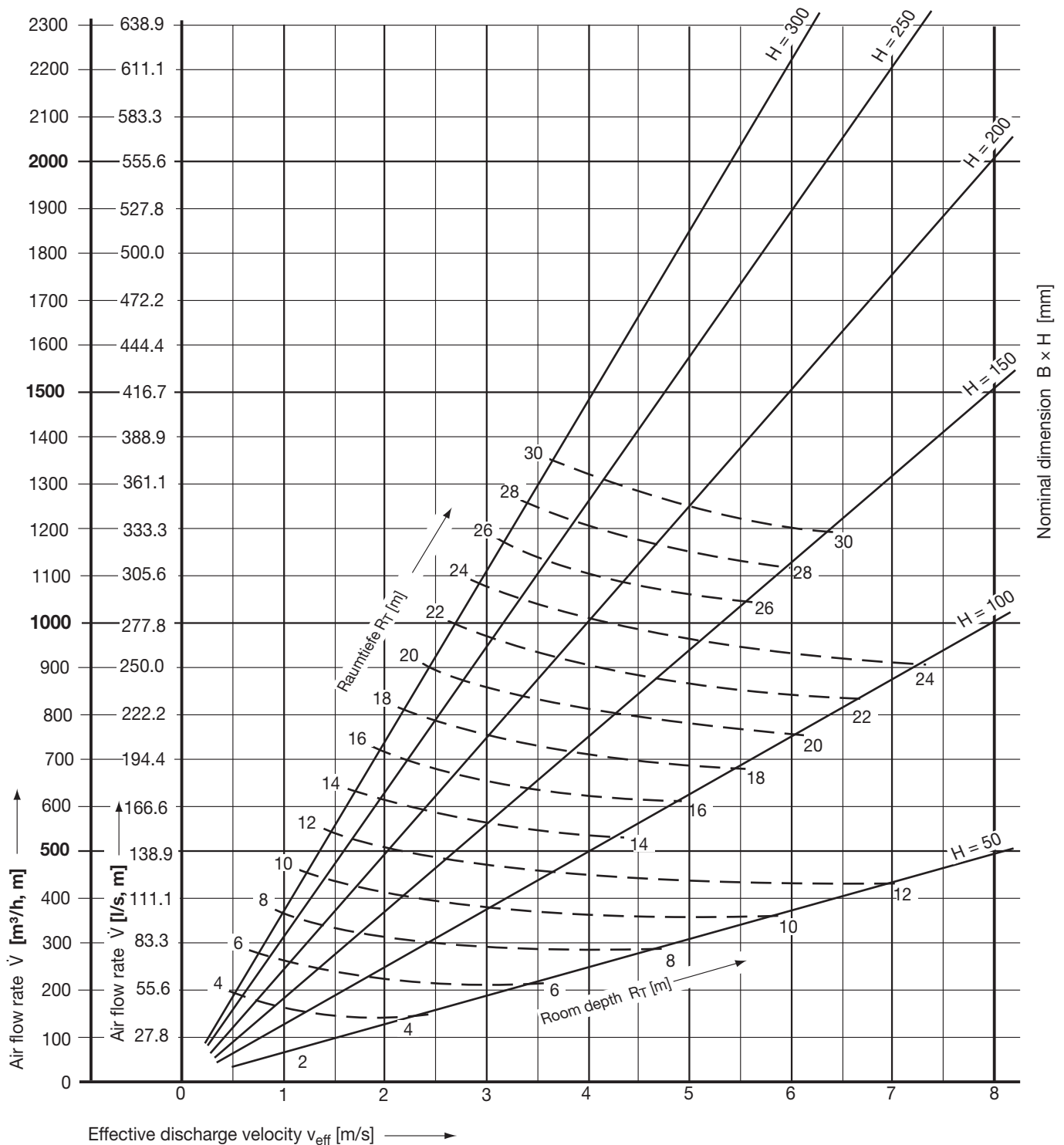
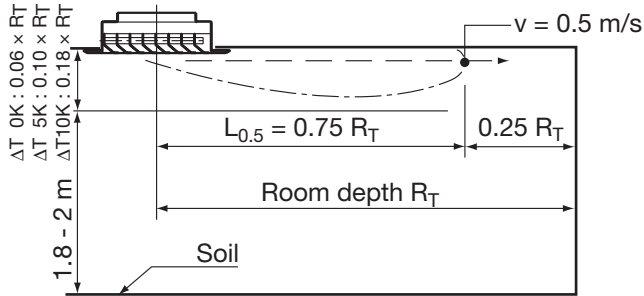

Linear ceiling diffusers – 'linear air terminal – two-sided discharge

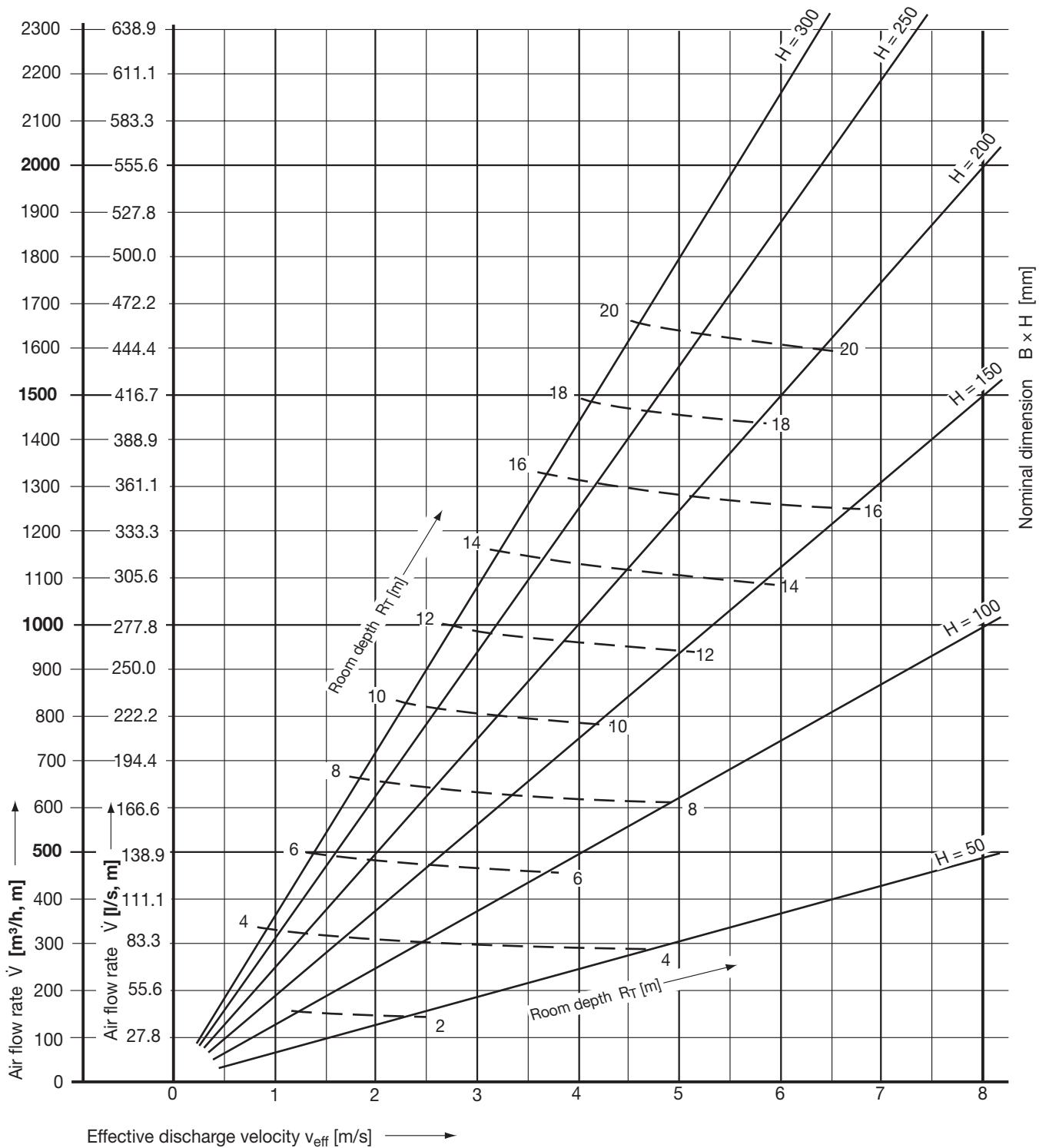
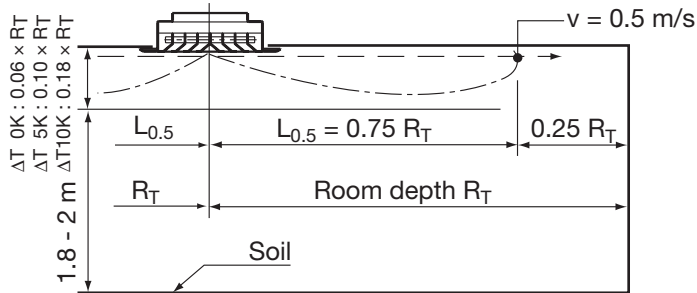

Order details

Order codes

No details for standard products

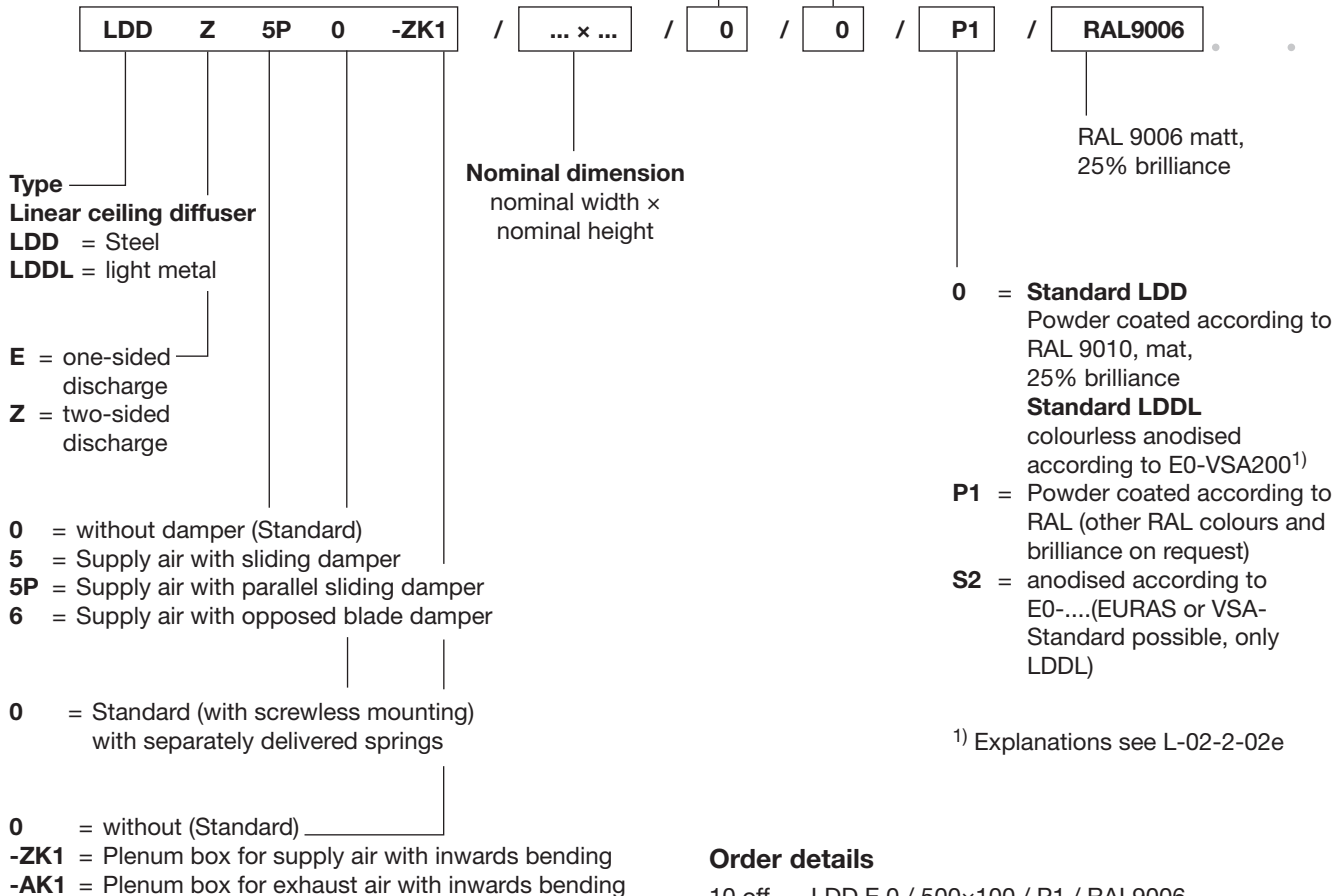

Order details

10 off LDD E 0 / 500×100 / P1 / RAL9006
 20 off LDDL Z 5P / 600×150
 5 off LDD E 0 -ZK1 / 600×100 / P1 / RAL9006

Text for tendering purposes

The linear ceiling diffusers consist of an angular frame with glued-on foam gasket. The removable blade grating is available with one or two-sided discharge.

Material

Variante 1

Frame and blades of steel profiles, color powder-coated RAL 9010, matt 25% brilliance

Variante 2

Frame and blades of light metal profiles, anodized colourless finish

Option

– Other RAL colours