

Ceiling diffusers

Type DD / DDRQ / DDQ

circular and square

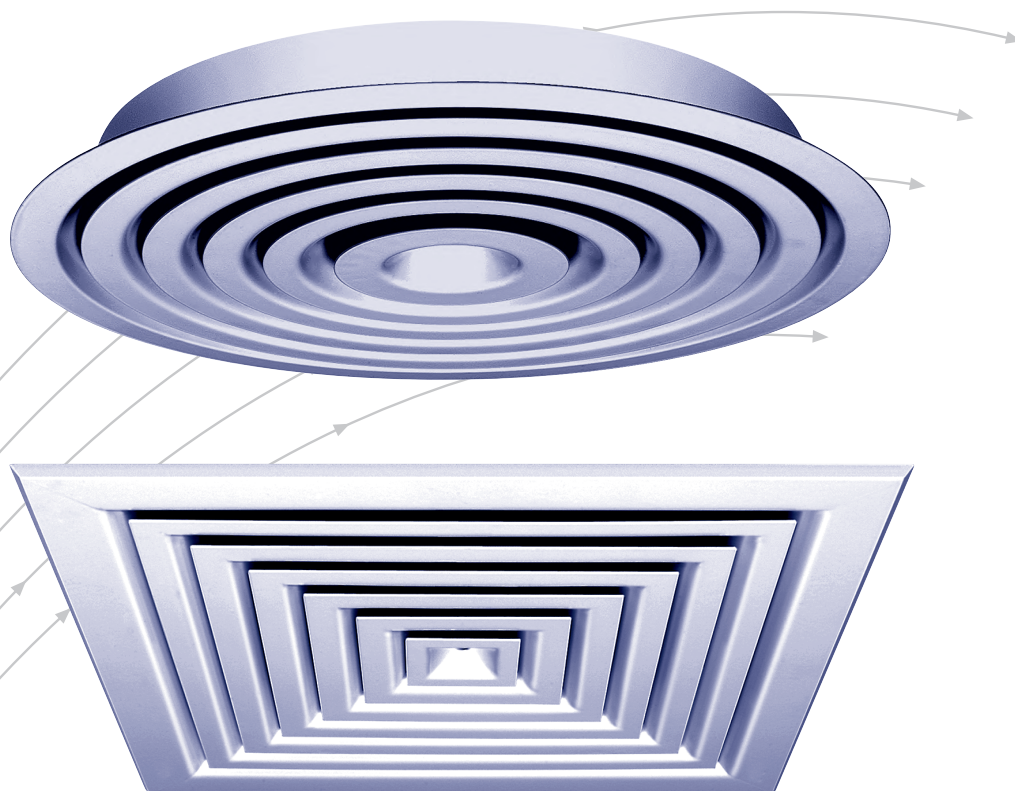

TROX[®] TECHNIK



The art of handling air

TROX HESCO Schweiz AG
Walderstrasse 125
Postfach 455
CH-8630 Rüti ZH

Tel. +41 55 250 71 11
Fax +41 55 250 73 10
www.troxhesco.ch
info@troxhesco.ch

Contents · Application · Safety instructions · Realisation · Dimensions

Contents

Application · Safety instructions · Realisation · Dimensions	2
Realisation · Dimensions	3
Realisation · Dimensions · Accessories	4
Installation	5
Technical Data	6–15
Order details	16

Application

The square ceiling diffusers and the circular ceiling diffusers are suitable for the introduction of supply air or the removal of extract air in the ceiling. They are available with circular or square exterior frames. The two designs, flat (type F) and conical (type K), differ - above all - in their free cross-section. They blow the air flat along the ceiling and therefore can also be employed for rooms with a low height.

Ceiling diffusers are suitable for:

- Installations with constant flow rates
- Installations with variable air volumes (VAV)

Safety instructions

CAUTION!

Damage to the product due to improper handling. Check the device for damage and contamination prior to operation!

Improper handling may lead to considerable material damage of the product.

- Do not use any acid or abrasive cleaning agents.
- Adhesives from sticky tape may lead to colour damage.
- Excessive moisture may lead to colour damage and corrosion.
- Use only cleaning agents, greases and oils that are expressly specified.

CAUTION!

Risk of injury from sharp edges and corners, ridges and thin-walled sheet metal parts!

- Proceed carefully with all work.
- Wear protective gloves, safety shoes and protective helmet.

WARNING!

Danger from incorrect use. Misuse of the product may lead to dangerous situations.

The product must not be used:

- in areas subject to explosion hazards;
- in the open air without sufficient protection against weather effects;
- in atmospheres that may have a damaging and/or corrosive effect on the product due to scheduled or unscheduled chemical reactions.

Realisation

Circular with circular exterior frame type DD

Material and colour

Steel, powder-coated according to RAL 9010, matt, 25% brilliance

Fixation: by means of a central screw

Damper

Sliding damper

Aluminium untreated
(possibility of adjustment from below
by means of a concealed lever)

Type DD F

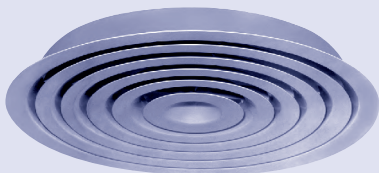

Type DD K

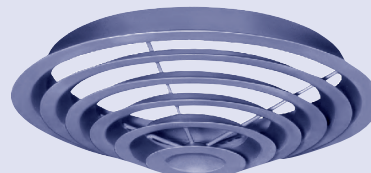

Dimensions

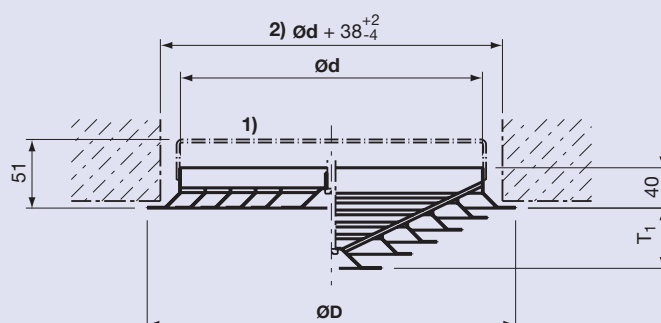

- 1) Sliding damper
- 2) Recess

Type	ND	∅D [mm]	∅d (external) [mm]	T1 [mm]
 DD	150	216	152	24
	200	266	202	26
	250	316	252	48
	300	366	302	60
	400	466	402	84
	500	566	502	108

Realisation

Circular within square exterior ceiling plate type DDRQ

Material and colour

Steel, powder-coated according to RAL 9010, matt, 25% brilliance

Fixation possibility: by means of a central screw or inserted in the ceiling construction.

Damper

Sliding damper: Aluminium untreated
(possibility of adjustment from below by means of a concealed lever)

Type DDRQ F

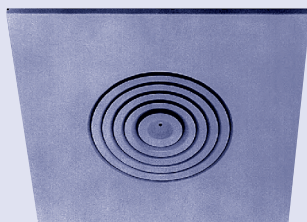

Type DDRQ K

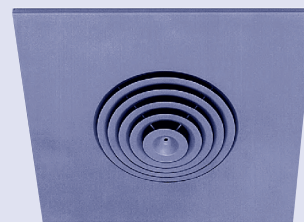

Dimensions



1) Sliding damper

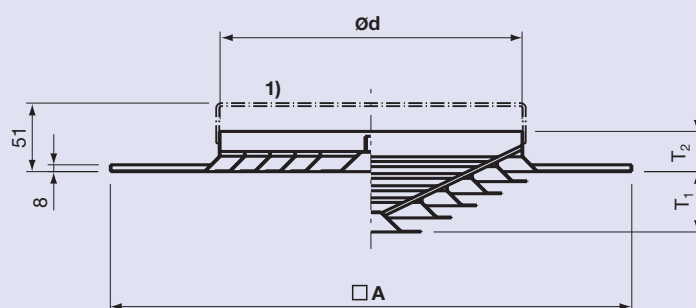

Type	ND	□ A [mm]	∅d (external) [mm]	T1 [mm]	T2 [mm]
 DDRQ	150	598x	152	24	40
	200		202	26	40
	250		252	48	40
	300	623x	302	60	24
	400		402	84	24
	500		502	108	24

Realisation

Square type DDQ

Material and colour

Steel, powder-coated according to RAL 9010, matt, 25% brilliance

Fixation possibility

by means of a central screw

Damper

Sliding damper
opposed blade damper

Aluminium untreated
Frame: Hot galvanized steel
Blades: Aluminium untreated
(possibilities of adjustment from below by means of a concealed lever)

Realisation · Dimensions · Accessories

Type DDQ F

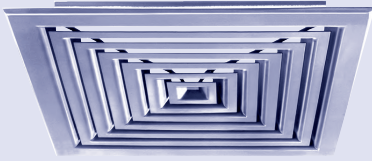

Type DDQ K

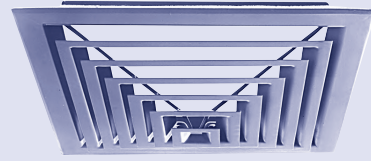

Dimensions

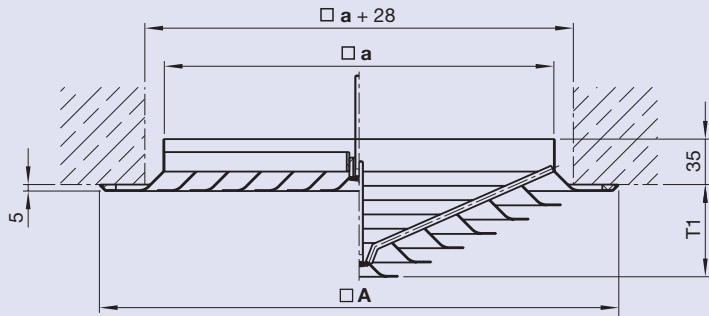

View from below

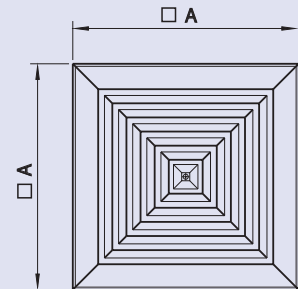

Type	ND	□ A [mm]	□ a (external) [mm]	T1 [mm]
	300×200	300	202	49
	400×300	400	302	71
	500×400	500	402	93
DDQ	600×500	600	502	115
	625×500	625	502	115

Accessories

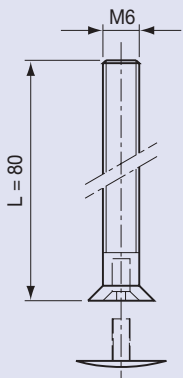

Central screw with plastic plug
for type DDQ F, DD F and DDRQ F
For the installation with the plenum box AKH... and the **conical** diffuser, **longer** central screws are provided.

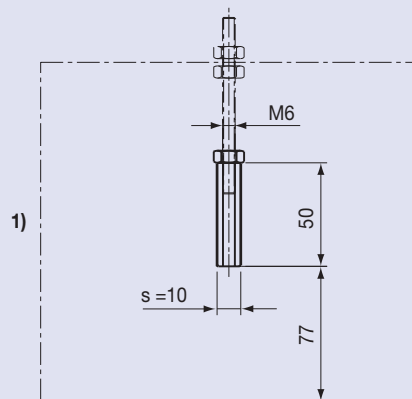

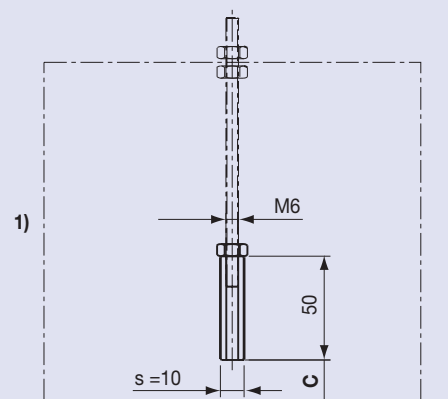

Threaded pipe coupling GRM6
for type DDQ F, DD F and DDRQ F

1) builder's supply (p.e. duct)



Threaded pipe coupling GRM6
for type DDQ K, DD K and DDRQ K

1) builder's supply (p.e. duct)

Type DD / DDRQ		Ød [mm]	152	202	252	302	402	502
		C [mm]	80	50	37	25	0	-22
Type DDQ		□ a [mm]	202	302	402	502		
		C [mm]	32	10	-12	-34		



Circular with square exterior ceiling plate type DDRQ with plenum box

Type DDRQ K

Inserted in ceiling profile from above.

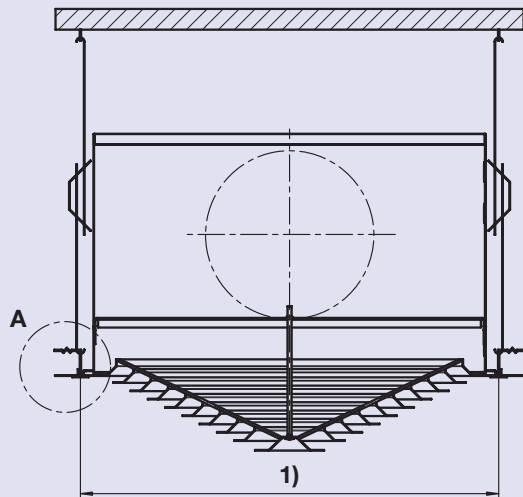

1) Grid dimension

Type DDRQ K

Pressed onto ceiling profile from below.

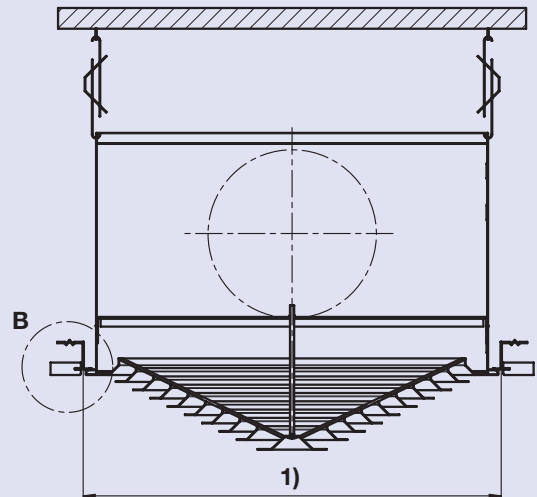

Type DDRQ F

Inserted in ceiling profile from above.

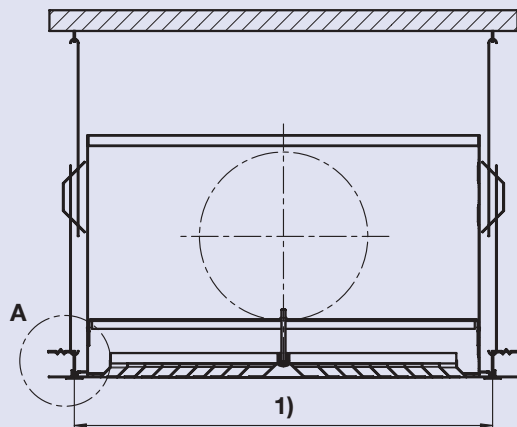

1) Grid dimension

Type DDRQ F

Pressed onto ceiling profile from below.

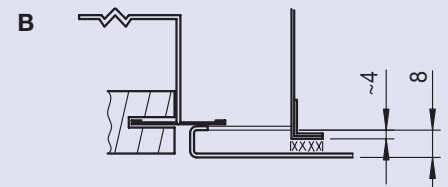
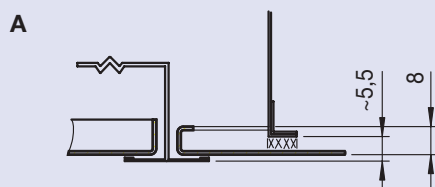
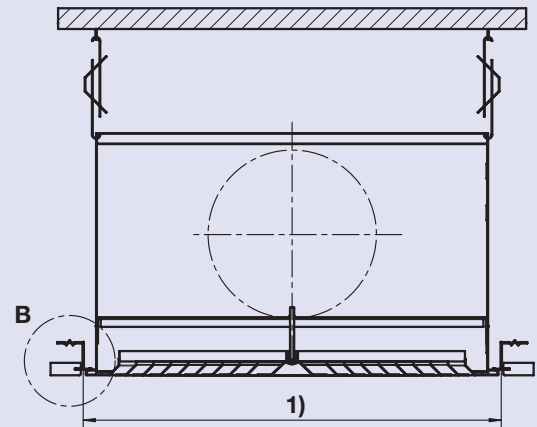

Type	ND	Grid dimension [mm]	Plenum box Details see prospect L-04-1-31e (TROX HESCO) or 2/16.4/... (TROX)
 DDRQ	598x...	600x600	
	623x...	625x625	

Technical Data

Technical documentation

1. Our data are based on a maximum difference in temperature Δt of -10 K between room air and supply air temperature. The expected room air velocities are still within the comfort range. Columns located within the stream of air are to be protected by blocking the corresponding sector in the diffuser.
2. In the case of systems supplying hot air, it is advisable to locate the ceiling diffusers only up to a maximum room height R_H of 3.2 m.

Definitions

A	m ²	Nominal area of diffuser
A _{eff}	m ²	Effective free area
A ₀	m ²	Nominal reference area
Ød	mm	The diffuser size for circular ceiling diffuser
□a	mm	The diffuser size for square ceiling diffuser
b	mm	Width of jet for square ceiling diffuser
D	m	Distance between two ceiling diffusers
f	Hz	Octave-centre-frequencies
h _{0K}	m	Thickness of jet (from ceiling) with isothermal air jet
h _{10K}	m	Thickness of jet (from ceiling) with cold air stream $\Delta t = 10$ K(-)
L	m	Distance (by a final velocity of 0.5 m/s in the throw axis)
L _w	dB(A)	Sound power level
L _{wA0}	dB(A)	Sound power level in relation to the nominal reference area A ₀
ΔL _w	dB	Correction "sound power level" [dB(A)] as a function of the diffuser size
Δp _s	Pa	Static pressure drop
r _{ØF}	-	Ratio A"/A with circular, flat ceiling diffuser = abt. 0.33 = abt. 33%
r _{ØK}	-	Ratio A"/A with circular, conical ceiling diffuser = abt. 0.73 = abt. 73%
r _{∅F}	-	Ratio A"/A with square, flat ceiling diffuser = env. 0.32 = env. 32%
r _{∅K}	-	Ratio A"/A with square, conical ceiling diffuser = env. 0.575 = env. 57,5%
R _H	m	Room height
v _{eff}	m/s	Effective blow-out velocity
Ḃ	m ³ /h	Air flow rate

Minimum distances

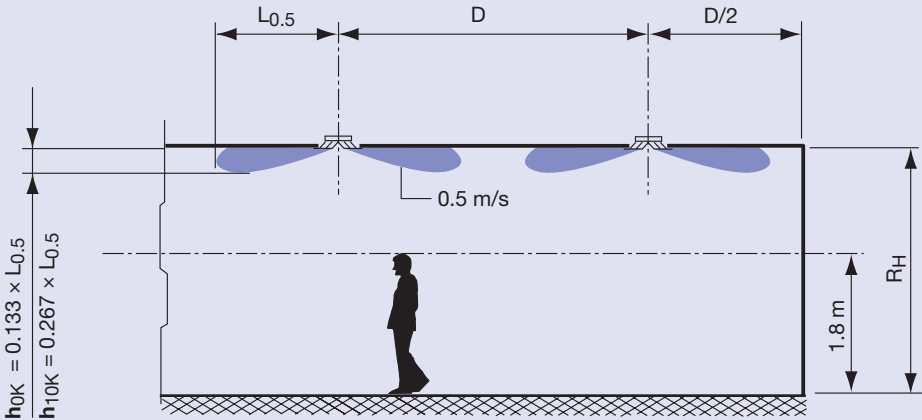

Minimum distances by type DD and DDRQ

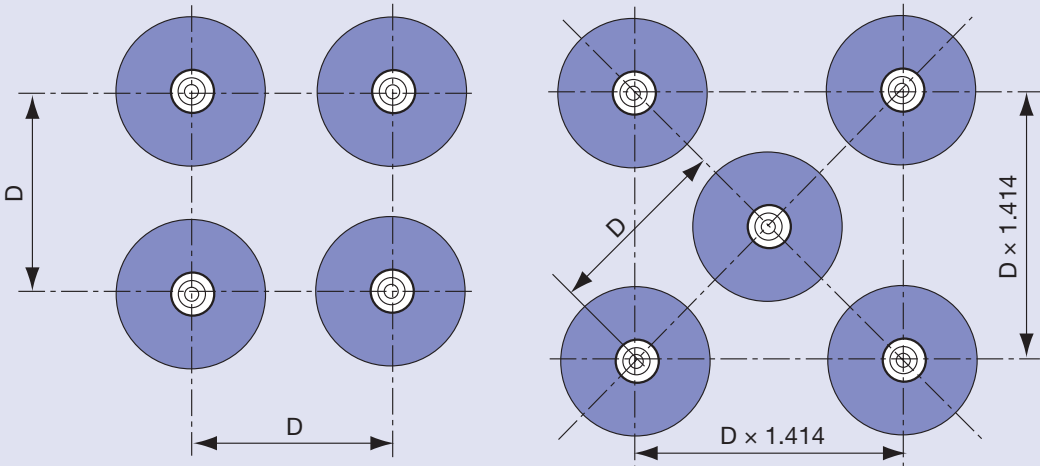
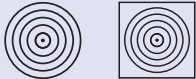

Minimum distances by type DDQ

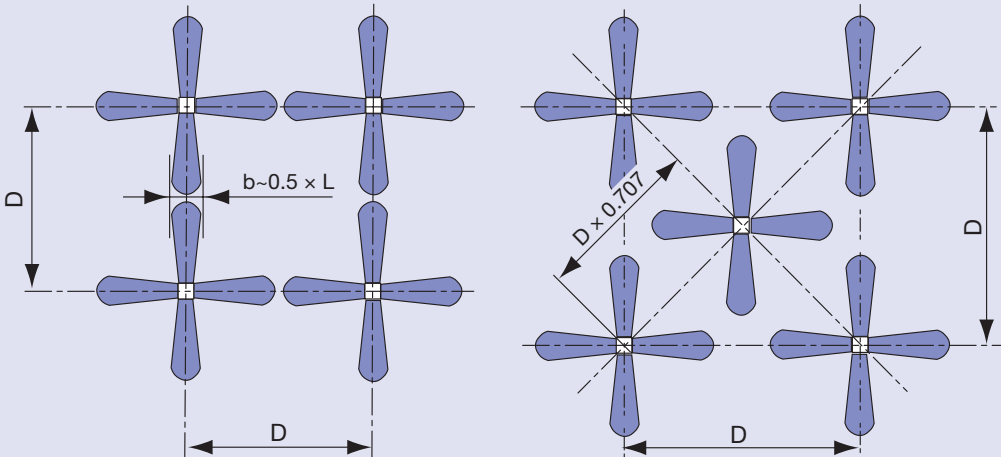

Technical Data

Selection diagram – supply air

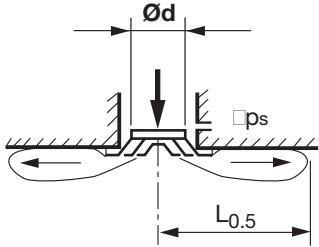
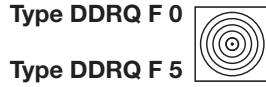
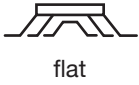

eff. free cross section: ~33%

Room height R_H [m]	Min. distance D as a function of room height R_H [m]
2.25 - 2.50	1.5 2 3 4 5 6 7 8 9 10 15
2.51 - 2.80	1.5 2 3 4 5 6 7 8 9 10 15
2.81 - 3.20	1.5 2 3 4 5 6 7 8 9 10 15
3.21 - 3.75	1.5 2 3 4 5 6 7 8 9 10 15
3.76 - 4.50	1 1.5 2 3 4 5 6 7 8 9 10 15

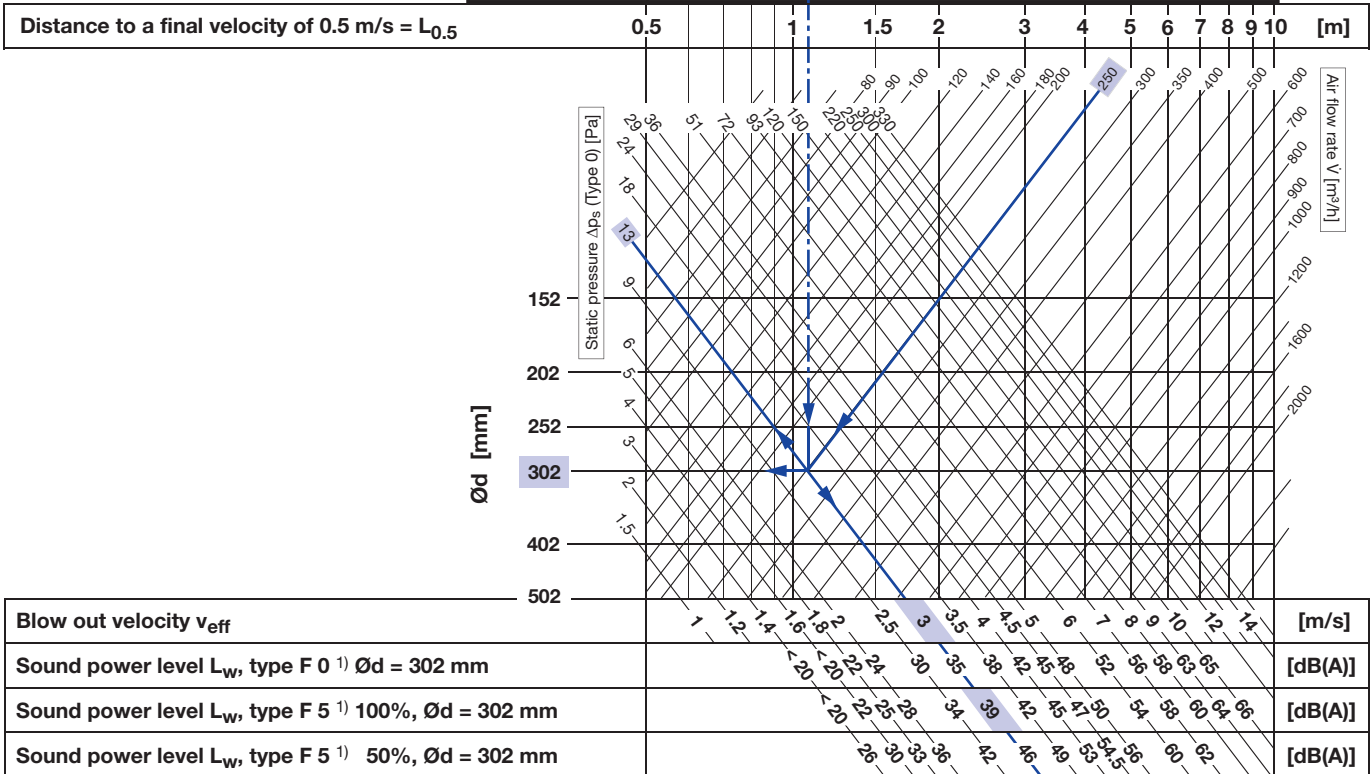

¹⁾ Data applicable for: supply air straight introduced, flat double ceiling; F 0 = flat without damper; F 5 = flat with sliding damper

Corrections

Correction 'pressure drop'

with F 5 - 100% open	$\Delta p_s = 1.32 \times \Delta p_{s0}$	[Pa]
with F 5 - 50% open	$\Delta p_s = 2.45 \times \Delta p_{s0}$	[Pa]

Δp_{s0} = static pressure drop without damper

Correction 'sound power level' as a function of the diffuser size

$\text{Ø}d$	152	202	252	302	402	502	[mm]
ΔL_w	-3	-2	-1	0	+1	+2	[dB]

Example given

Type DD F 5 (with sliding damper 100% open)
 $R_H = 3.0$ m
 $D = 2.4$ m
 $\dot{V} = 250$ m³/h

Solution
 $\text{Ø}d = 302$ mm
 $v_{eff} = 3.0$ m/s
 $\Delta p_s = 13 \times 1.32 = 17$ Pa
 $L_w = 39$ dB(A)
 $L_{0.5} = 1.1$ m

Selection diagram – supply air



Type DD K 0



Type DD K 5

Type DDRQ K 0



Type DDRQ K 5

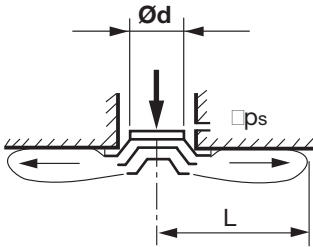

eff. free cross section: ~73%

Room height R_H [m]	Min. distance D as a function of room height R_H [m]
2.25 - 2.50	1.5 2 3 4 5 6 7 8 9 10 15
2.51 - 2.80	1.5 2 3 4 5 6 7 8 9 10 15
2.81 - 3.20	1.5 2 3 4 5 6 7 8 9 10 15
3.21 - 3.75	1.5 2 3 4 5 6 7 8 9 10 15
3.76 - 4.50	1 1.5 2 3 4 5 6 7 8 9 10 15

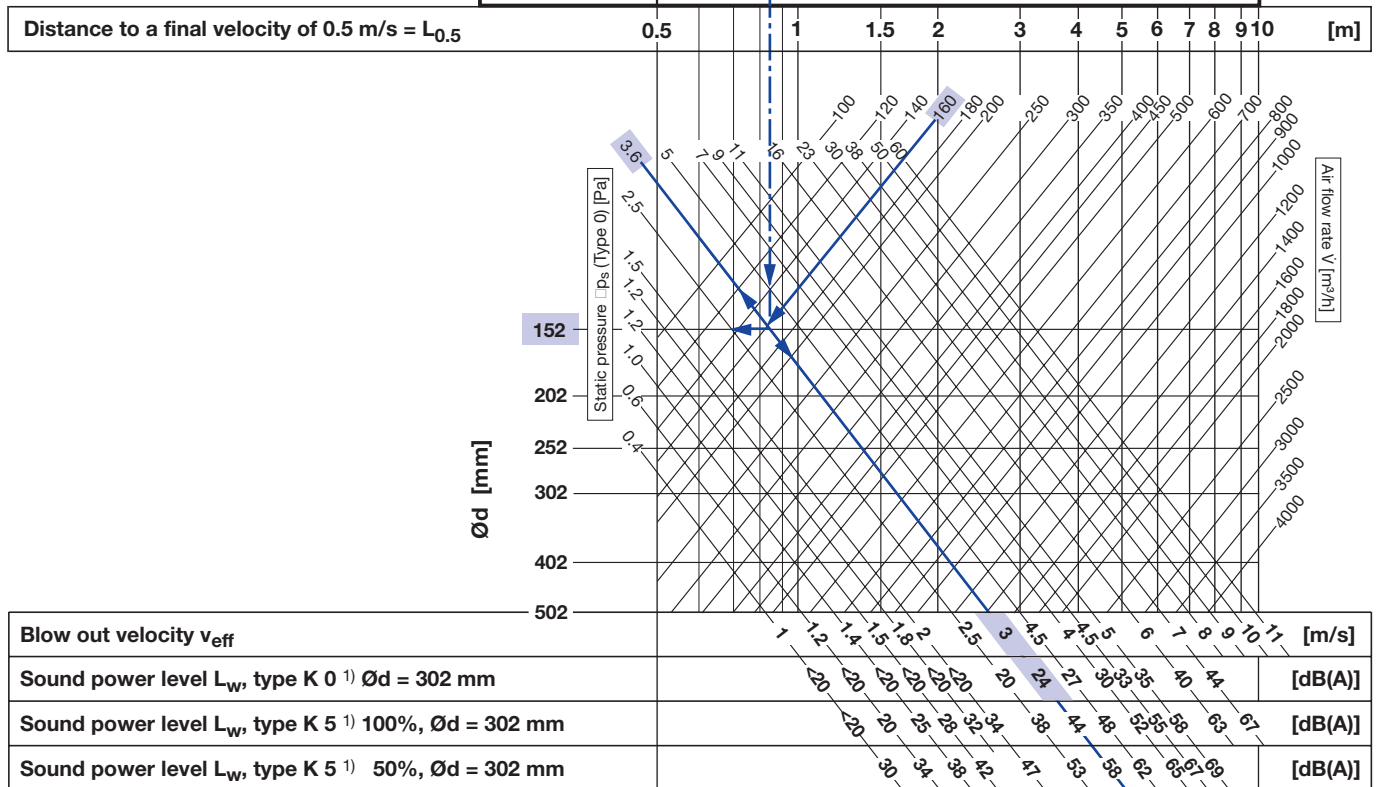

¹⁾ Data applicable for: supply air straight introduced, flat double ceiling; K 0 = conical without damper; K 5 = conical with sliding damper

Corrections

Correction 'pressure drop'

with K 5 - 100% open	$\square p_s = 1.32 \times \square p_{s0}$	[Pa]
with K 5 - 50% open	$\square p_s = 2.45 \times \square p_{s0}$	[Pa]

$\square p_{s0}$ = static pressure drop without damper

Correction 'sound power level' as a function of the diffuser size

$\varnothing d$	152	202	252	302	402	502	[mm]
$\square L_w$	-3	-2	-1	0	+1	+2	[dB]

Example given

Type DD K 0 (with sliding damper 100% open)
 $R_H = 2.3$ m
 $D = 2.2$ m
 $\dot{V} = 160$ m³/h

Solution
 $\varnothing d = 152$ mm
 $v_{eff} = 3.0$ m/s
 $\Delta p_s = 4$ Pa
 $L_w = 24 - 3 = 21$ dB(A)
 $L_{0.5} = 0.85$ m

Technical Data

Selection diagram – supply air

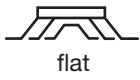

Type DDQ F 0



Type DDQ F 6

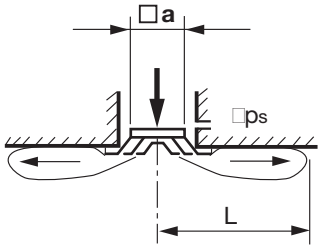

eff. free cross section: ~32%

Room height R_H [m]	Min. distance D as a function of room height R_H [m]
2.25 - 2.50	1.5 2 3 4 5 6 7 8 9 10 15
2.51 - 2.80	1.5 2 3 4 5 6 7 8 9 10 15
2.81 - 3.20	1.5 2 3 4 5 6 7 8 9 10 15
3.21 - 3.75	1.5 2 3 4 5 6 7 8 9 10 15
3.76 - 4.50	1 1.5 2 3 4 5 6 7 8 9 10

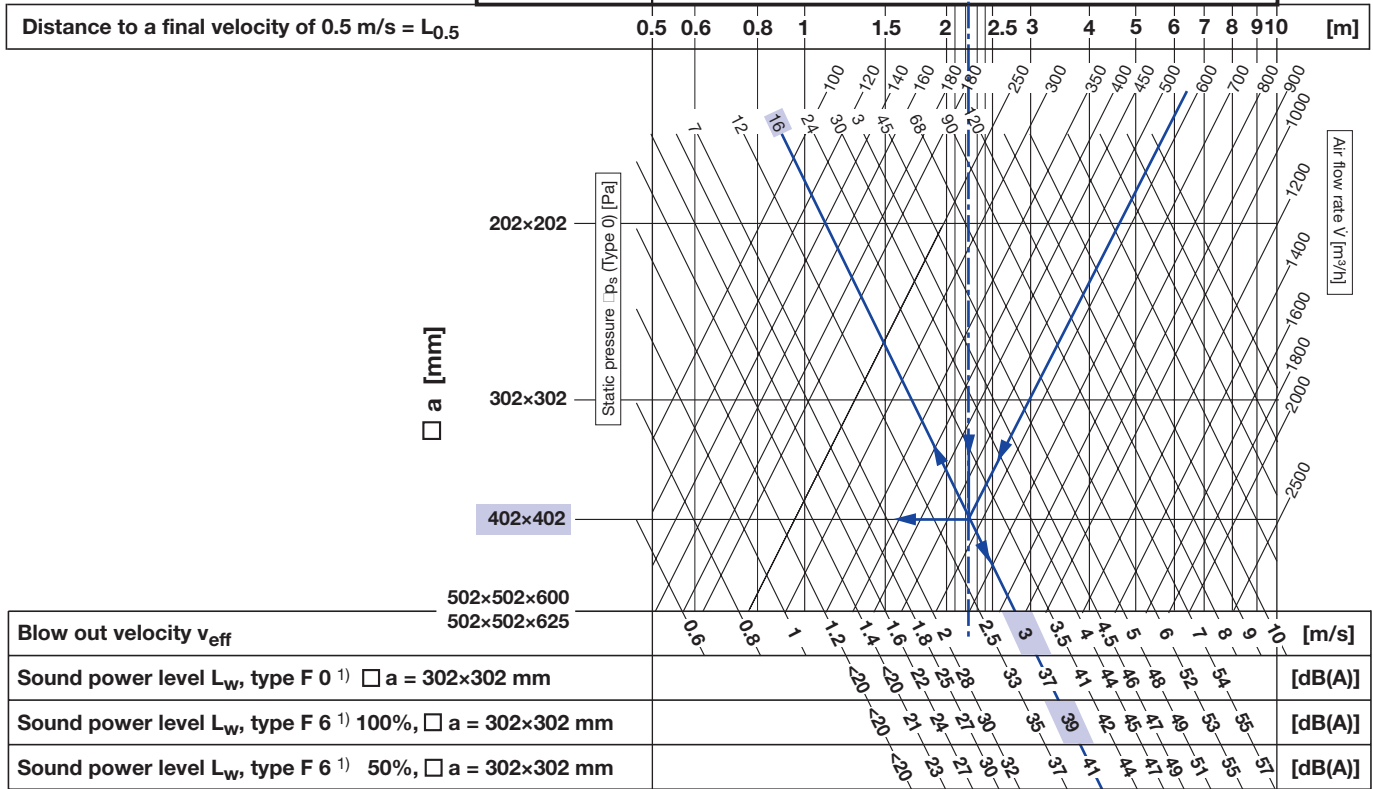

¹⁾ Data applicable for: supply air straight introduced, flat double ceiling; F 0 = flat without damper; F 6 = flat with sliding damper

Corrections

Correction 'pressure drop'

with F 6 - 100% open	$\square p_s = 1.10 \times \square p_{s0}$	[Pa]
with F 6 - 50% open	$\square p_s = 1.50 \times \square p_{s0}$	[Pa]

$\square p_{s0}$ = static pressure drop without damper

Correction 'sound power level' as a function of the diffuser size

a	202x202	302x302	402x402	502x502	[mm]
L_w	-1	0	+1	+2	[dB]

Example given

Type DDQ F 6 (with opposed blade damper 100% open)
 $R_H = 3.0$ m
 $D = 5.0$ m
 $\dot{V} = 560$ m³/h

Solution

$a = 402 \times 402$ mm
 $v_{eff} = 3.0$ m/s
 $\Delta p_s = 16 \times 1.1 = 18$ Pa
 $L_w = 39 + 1 = 40$ dB(A)
 $L_{0.5} = 2.2$ m

Selection diagram – supply air



Type DDQ K 0

Type DDQ K 6

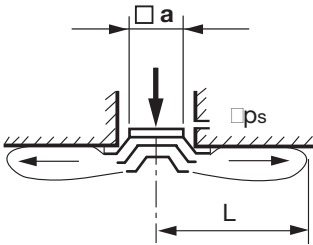

eff. free cross section: ~57.5%

Room height R_H [m]	Min. distance D as a function of room height R_H [m]
2.25 - 2.50	1.5 2 3 4 5 6 7 8 9 10 15
2.51 - 2.80	1.5 2 3 4 5 6 7 8 9 10 15
2.81 - 3.20	1.5 2 3 4 5 6 7 8 9 10 15
3.21 - 3.75	1.5 2 3 4 5 6 7 8 9 10 15
3.76 - 4.50	1 1.5 2 3 4 5 6 7 8 9 10 15

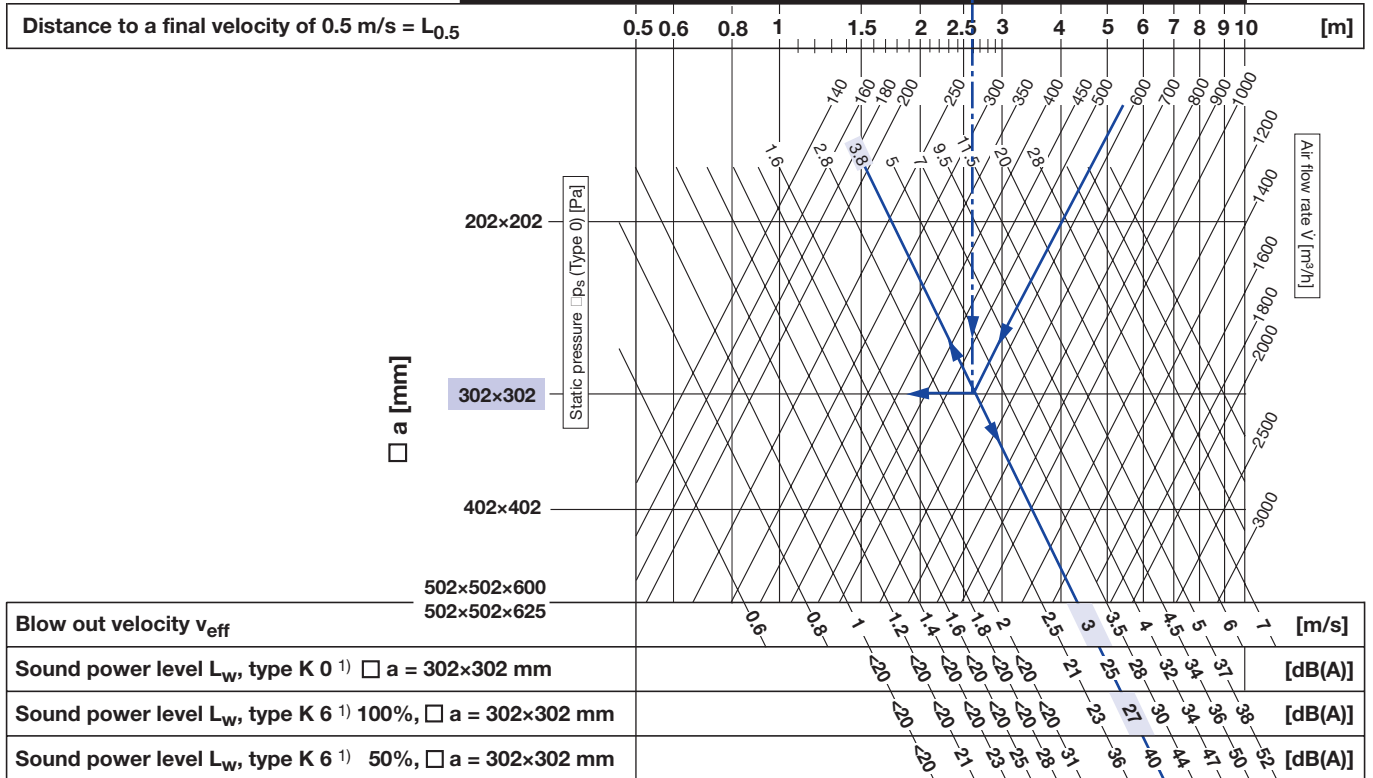

¹⁾ Data applicable for: supply air straight introduced, flat double ceiling; K 0 = conical without damper; K 6= conical with sliding damper

Corrections

Correction 'pressure drop'

with K 6 - 100% open	$\Delta p_s = 1.15 \times \Delta p_{s0}$	[Pa]
with K 6 - 50% open	$\Delta p_s = 5.60 \times \Delta p_{s0}$	[Pa]

Δp_{s0} = static pressure drop without damper

Correction 'sound power level' as a function of the diffuser size

$\square a$	202×202	302×302	402×402	502×502	[mm]
ΔL_w	-1	0	+1	+2	[dB]





Example given



Type DDQ K 6 (with opposed blade damper 100% open)
 $R_H = 3.0$ m
 $D = 5.8$ m
 $\dot{V} = 560$ m³/h

Solution
 $\square a = 302 \times 302$ mm
 $v_{eff} = 3.0$ m/s
 $\Delta p_s = 3.8 \times 1.15 = 5$ Pa
 $L_w = 27$ dB(A)
 $L_{0.5} = 2.7$ m

Technical Data

Correction table for the octave centre frequencies

Type	Damper position	Type	f	125	250	500	1k	2k	4k	8k	[Hz]
 DD	flat  100, 75 and 50% open	DD F 0 DDRQ F 0 DD F 5 DDRQ F 5		-2	+1	0	-6	-12	-20	< (-22)	[dB]
	25% open	DD F 5 DDRQ F 5		-2	+4	-2	-7	-9	-11	< (-20)	
 DDRQ	conical  100, 75, 50 and 25% open	DD K 0 DDRQ K 0		+1	-1	-3	-5	< (-11)	< (-18)	< (-22)	
		DD K 5 DDRQ K 5		+2	+4	0	-5	-5	-8	< (-22)	
Tolerances of the octave corrections: ±4 [dB]											

Type	Damper position	Type	f	125	250	500	1k	2k	4k	8k	[Hz]
 DDQ	flat  100, 75, 50 and 25% open	DDQ F 0 DDQ F 6		0	+2	-3	-7	-14	< (-20)	< (-20)	[dB]
	conical  100, 75 and 50% open	DDQ K 0 DDQ K 6		+4	+6	-2	-5	-12	< (-20)	< (-20)	
	25% open	DD K 6		-6	-4	-7	-3	-7	-13	< (-20)	
Tolerances of the octave corrections: ±4 [dB]											

Example

Given

Example from page 8, (DD F 5, 100% open, instead of $\varnothing d = 302 \text{ mm}$ $\varnothing d = 402 \text{ mm}$ is selected)

Sought

Level of the octave centre frequencies

Solution

Step 1:

Make size correction, i.e.:

$$L_w = L_w \varnothing d 302 \text{ mm} = 39 \text{ dB(A)}$$

correction for $\varnothing d 402 \text{ mm} = +1$



$$L_w = 39 + 1 = 40 \text{ dB(A)}$$

Step 2:

Calculate level of the octave centre frequencies

	f	125	250	500	1k	2k	4k	8k	[Hz]
$L_{wA} \varnothing d = 402 \text{ mm}$		40	40	40	40	40	40	40	[dB(A)]
L_A		-2	+1	0	-6	-12	-20	< (-22)	[dB]
L_{wOkt}		38	41	40	34	28	20	< 18	[dB]

1. Supply air with plenum box

Type	Ød	Plenum box Type	DD / DDRQ				DD K / DDRQ K							
			flat				conical							
			fL _w	f _p	fL _w	f _p	fL _w	f _p	fL _w	f _p				
 DD DDRQ	152	AKH08 ZL-Ø160	0.97	2.7			1.12	2.7						
	202	AKH09 ZL-Ø160	1.00	2.8			1.50	3.6						
	252	AKH01 ZL-Ø160	1.09	3.1			2.01	5.1						
	302	AKH02 ZL-Ø200	1.09	3.1			1.89	4.6						
	402	AKH03 ZL-Ø200	1.21	4.4			2.63	8.4						
	502	AKH04 ZL-Ø250	1.27	4.2			2.52	7.3						

Note: With DDRQ and DDRQ K a plenum box up to size AKH04 can be selected.

Example

Given

- Supply air
- DDRQ K 0 / 623x500 with AKH04 ZL..., 1 x Ø 248 mm
- $v_{eff} = 2.5$ m/s

Sought



- a) $L_w = ?$
b) $\Delta p_s = ?$

Solution from diagram page 9

a) $L_w = 20$ dB(A)
correction for AKH04 ZL: $fL_w = 2.52$
 $L_w = 20 \times 2.52 = 50$ dB(A)

b) $\Delta p_s = 2.5$ Pa
correction for AKH04 ZL: $f\Delta p_s = 7.3$
 $\Delta p_s = 2.5 \times 7.3 = 18$ Pa

2. Extract air with plenum box

Type	Ød	Plenum box Type	DD / DDRQ						DD K / DDRQ K					
			flat						conical					
			F 0		F 5 - 100%		F 5 - 50%		K 0		K 5 - 100%		K 5 - 50%	
			□L _w	f _p s	□L _w	f _p s	□L _w	f _p s	□L _w	f _p s	□L _w	f _p s	□L _w	f _p s
 DD DDRQ	152	AKH08 AL-Ø160	-5	1.10	-7	1.60	-7	1.80	+9	6.00	-5	11.00	-8	29.00
	202	AKH09 AL-Ø160	-3	1.40	-5	1.85	-5	2.10	+10	6.10	-4	11.20	-6	29.40
	252	AKH01 AL-Ø160	+3	1.70	-2	2.13	-2	2.40	+11	6.10	-3	11.45	0	29.60
	302	AKH02 AL-Ø200	+7	2.20	0	2.45	-1	2.80	+12	6.15	-3	11.60	+3	33.60
	402	AKH03 AL-Ø200	+9	3.30	0	3.45	+4	4.55	+21	17.75	+8	22.00	+8	40.40
	502	AKH04 AL-Ø250	+8	2.10	-1	2.40	+1	2.95	+22	17.50	+10	19.50	+10	40.40

Note: With DDRQ and DDRQ K a plenum box up to size AKH04 can be selected.

Example

Given

- Extract air
- DDRQ K 5 / 598x200 (with sliding damper 100% open) with AKH09 AL, 1 x Ø 160 mm
- $v_{eff} = 3.0$ m/s

Sought

- a) $L_w = ?$
b) $\Delta p_s = ?$

Solution from diagram page 9

a) $L_w = 44$ dB(A)
correction for AKH09 AL: $\Delta L_w = -4$
 $L_w = 44 - 4 = 40$ dB(A)

b) $\Delta p_s = 3.6$ Pa
correction for AKH09 AL: $f\Delta p_s = 11.2$
 $\Delta p_s = 3.6 \times 11.2 = 40$ Pa

Technical Data

3. Extract air without plenum box

Extract air (only diffusers with and without damper)

Correction table for circular ceiling diffusers

Circular with circular exterior frames Type DD

Circular within square exterior ceiling plate Type DDRQ

Basis:



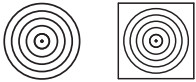

Diagram values of DD-dimensions (supply air)

a) Sound power level $L_{WA AL} = L_{WA ZL} + \Delta L_w$

b) Static pressure drop: $\Delta p_{SAL} = \Delta p_{SZL} \times f \Delta p_s$



Extract air

Type	Ød	flat 						conical 					
		F 0		F 5 – 100%		F 5 – 50%		K 0		K 5 – 100%		K 5 – 50%	
		ΔL _w	fΔp _s	ΔL _w	fΔp _s	ΔL _w	fΔp _s	ΔL _w	fΔp _s	ΔL _w	fΔp _s	ΔL _w	fΔp _s
DD 	152	-14	1.10	-10	2.00	-7	7.50	-11	3.30	-8	3.80	-7	8.10
	202	-12	1.15	-8	2.25	-5	8.10	-9	3.55	-6	4.05	-5	8.40
	252	-5	1.20	-5	2.55	-3.5	8.95	-4	3.85	-3.5	4.35	-3	8.95
DDRQ 	302	+1	1.25	-3	2.85	-2	9.70	+1	4.25	-2	5.00	-1	9.50
	402	+6	1.35	-1	3.1	0	10.55	+6	5.00	0	5.30	+1	10.35
	502	+7	1.60	+1	2.85	+2	10.40	+7	6.15	+1	6.65	+2	10.35

Example

Given

- Extract air
- DD F 5 / 300 (with sliding damper 50% open)
- $v_{eff} = 2.0$ m/s

Solution from diagram page 8



- a) $L_w = 36$ dB(A)
 correction for AKH... AL: $\Delta L_w = -2$
 $L_w = 36 - 2 = 34$ dB(A)

Sought

- a) $L_w = ?$
 b) $\Delta p_s = ?$

- b) $\Delta p_s = 6$ Pa
 correction for AKH... AL: $f \Delta p_s = 9.70$
 $\Delta p_s = 6 \times 9.70 = 58$ Pa

1. Supply air with plenum box

Type	□ a	Plenum box Type	flat 		conical 	
			fL _w	f□p	fL _w	f□p
DDQ 	202	AKH09 ZL-Ø160	1.05	2.8	1.71	3.9
	302	AKH02 ZL-Ø200	1.11	3.1	2.17	5.3
	402	AKH03 ZL-Ø200	1.24	3.6	2.95	7.4
	502	AKH04 ZL-Ø250	1.34	3.8	2.93	7.2

Example

Given

- Supply air
- DDQ F 0 / 300x200 with AKH09 ZL..., 1 x Ø 160 mm
- $v_{eff} = 3.5$ m/s

Solution from diagram page 10



- a) $L_w = 41$ dB(A)
 correction for AKH09 ZL: $fL_w = 1.05$
 $L_w = 41 \times 1.05 = 43$ dB(A)

Sought

- a) $L_w = ?$
 b) $\Delta p_s = ?$

- b) $\Delta p_s = 24$ Pa
 correction for AKH09 ZL: $f \Delta p_s = 2.8$
 $\Delta p_s = 24 \times 2.8 = 67$ Pa

2. Extract air with plenum box

Type	□ a	Plenum box Type	flat 						conical 					
			F 0		F 6 - 100%		F 6 - 50%		K 0		K 6 - 100%		K 6 - 50%	
			□ L _w	f□ p _s	□ L _w	f□ p _s	□ L _w	f□ p _s	□ L _w	f□ p _s	□ L _w	f□ p _s	□ L _w	f□ p _s
 DDQ	202	AKH09 AL-Ø160	-17	0.85	-17	0.85	-18	0.90	+3	3.80	+2	3.80	-10	5.90
	302	AKH02 AL-Ø200	-6	1.35	-6	1.30	-8	1.43	+4	3.80	+3	3.80	-9	5.60
	402	AKH03 AL-Ø200	-3	2.60	-3	2.55	-6	0.78	+21	23.0	+12	26.0	+17	54.0
	502	AKH04 AL-Ø250	-2	1.85	-2	1.75	-5	1.95	+23	22.0	+15	32.0	+20	54.0

Example

Given

- Extract air
- DDQ K 0 / 300x200 with AKH04 AL..., 1 x Ø 160 mm
- $v_{eff} = 3.0$ m/s

Sought

- a) $L_w = ?$
b) $\Delta p_s = ?$

Solution from diagram page 11

a) $L_w = 25$ dB(A)
correction for AKH09 AL: $\Delta L_w = +3$
 $L_w = 25 + 3 = 28$ dB(A)

b) $\Delta p_s = 3.8$ Pa
correction for AKH09 AL: $f\Delta p_s = 3.8$
 $\Delta p_s = 3.8 \times 3.8 = 15$ Pa

3. Extract air without plenum box

Correction table for square ceiling diffusers

Square Type DDQ





Base:

Diagram values of DDQ - dimensions (supply air)

- a) Sound power level $L_{wA AL} = L_{wA ZL} + \Delta L_w$
b) Static pressure drop: $\Delta p_{SAL} = \Delta p_{SZL} \times f\Delta p_s$

Extract air (only diffusers with and without dampers)

Extract air without plenum box

Type	□ a	flat 						conical 					
		F 0		F 6 - 100%		F 6 - 50%		K 0		K 6 - 100%		K 6 - 50%	
		□ L _w	f□ p _s	□ L _w	f□ p _s	□ L _w	f□ p _s	□ L _w	f□ p _s	□ L _w	f□ p _s	□ L _w	f□ p _s
 DDQ	202	< (-10)	0.85	< (-10)	0.85	< (-10)	0.90	< (-10)	1.50	-3	1.45	-9	1.95
	302	-5	1.05	-5	1.0	-8	1.13	< (-10)	1.70	-2	1.60	-8	2.80
	402	-2	1.30	-5	1.20	-6	1.28	< (-10)	1.90	0	1.85	-6	3.65
	502	-1	1.30	-4	1.20	-5	1.28	< (-10)	1.90	+4	1.85	0	3.65

Example

Given

- Extract air
- DDQ K 6 / 400x300 (with opposed blade damper 100% open)
- $v_{eff} = 3$ m/s

Sought

- a) $L_w = ?$
b) $\Delta p_s = ?$

Solution from diagram page 11

a) $L_w = 27$ dB(A)
correction for AKH... AL: $\Delta L_w = -2$
 $L_w = 27 - 2 = 25$ dB(A)

b) $\Delta p_s = 3.8$ Pa
correction for AKH... AL: $f\Delta p_s = 1.60$
 $\Delta p_s = 3.8 \times 1.60 = 6$ Pa

Order details

Order codes

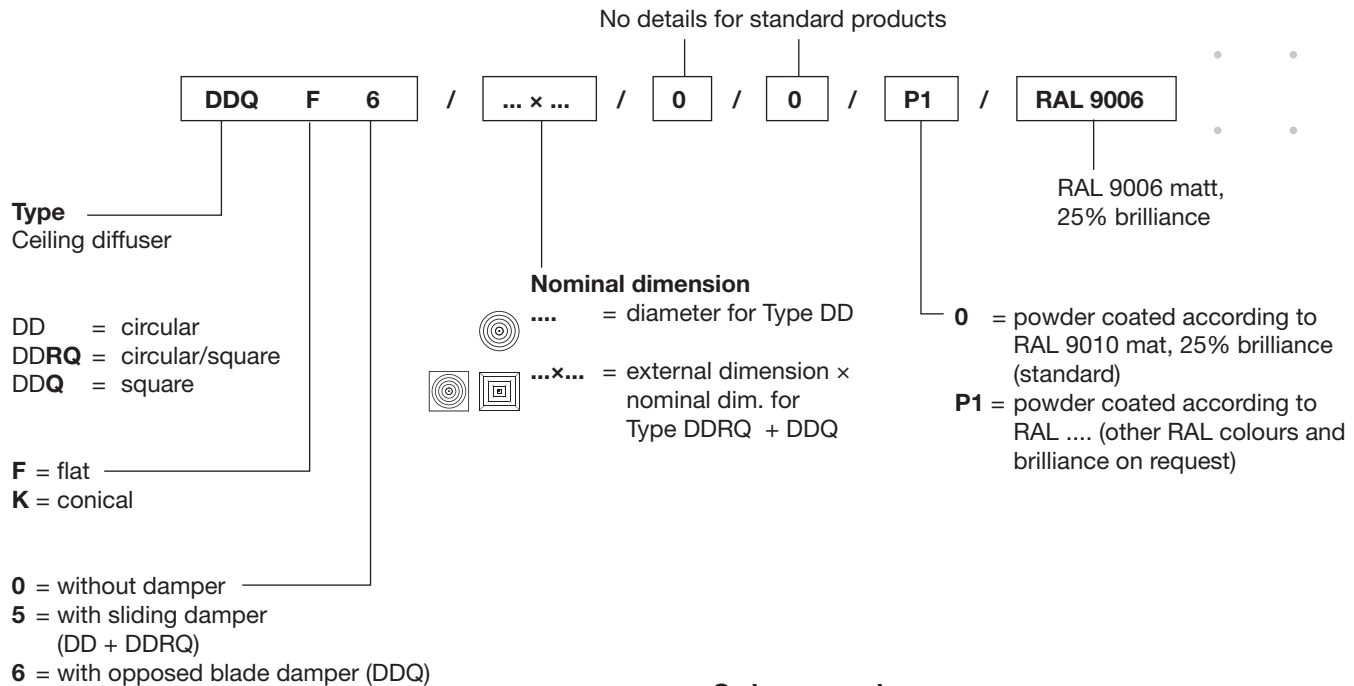

Order examples

15 off	DDQ F 0 / 500x400 / P1 / RAL 9006
20 off	DDQ K 6 / 600x500
15 off	DD F 5 / 500 / P1 / RAL 9006
20 off	DDRQ K 5 / 623x400

Text for tendering purposes

Type DD / DDRQ

Circular ceiling diffusers with or without square exterior frames for installation flush with the ceiling and uniform, circular air circulation. Comprising conical circular blades and flat exterior frames flush with the ceiling. Flat or conical design. With or without sliding damper for air volume control. Fixation by means of central screw.

Type DDQ

Square ceiling diffusers, blowing on all four sides, suitable for the horizontal introduction of air (or the removal of extract air). Flat or conical design. Comprising a front frame with plastic foam sealing and suitably-formed air-guidance blades. With or without opposed volume control (opposed blade damper). Fixation by means of central screw.

Plenum box for type DD / DDRQ and DDQ (see prospect L-04-1-31e)

A standard plenum box of galvanised steel, with integrated cross bar for the M6 central screw, for quick and simple installation of the ceiling panel air diffuser. A connection with volume control for connecting a spiral tube or hose is included; the inlet box also contains an air distributor element.

Material Diffuser

Steel, powder-coated according to RAL 9010, matt, 25% brilliance

Damper

Sliding damper	Aluminium untreated
Opposed blade damper	Frame: Hot galvanized steel Blades: Aluminium untreated

Plenum box

- Galvanised steel plate
- **Please note: deliveries with AKH ZL MO and AK1 ZL MO are without opposed blade damper.**

Option

- Other RAL-colours