

TOSHIBA

FILE NO. SVM-09029

SERVICE MANUAL

AIR CONDITIONER

SPLIT WALL TYPE

RAS-10SKHP-ES / RAS-10S2AH-ES
RAS-10SKP-ES / RAS-10SA-ES

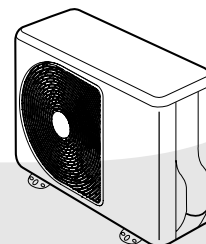
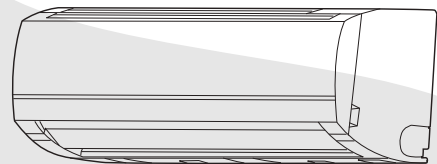

January, 2009

CONTENTS

- 1. SPECIFICATIONS**
- 2. CONSTRUCTION VIEWS**
 - 2-1 Indoor Unit
 - 2-2 Outdoor Unit
- 3. WIRING DIAGRAM**
 - 3-1 RAS-10SKHP-ES / RAS-10S2AH-ES
 - 3-2 RAS-10SKP-ES / RAS-10SA-ES
- 4. SPECIFICATION OF ELECTRICAL PARTS**
 - 4-1 Indoor Unit (RAS-10SKHP-ES)
 - 4-2 Outdoor Unit (RAS-10S2AH-ES)
 - 4-3 Indoor Unit (RAS-10SKP-ES)
 - 4-4 Outdoor Unit (RAS-10SA-ES)
- 5. REFRIGERATION CYCLE DIAGRAM**
 - 5-1 RAS-10SKHP-ES / RAS-10S2AH-ES
 - 5-2 RAS-10SKP-ES / RAS-10SA-ES
- 6. CONTROL BLOCK DIAGRAM**
 - 6-1 RAS-10SKHP-ES / RAS-10S2AH-ES
 - 6-2 RAS-10SKP-ES / RAS-10SA-ES
- 7. OPERATION DESCRIPTION**
 - 7-1 Remote control
 - 7-2 Outline of Air Conditioner Control
 - 7-3 Description of Operation Mode
 - 7-4 High-Temperature Limit Control
 - 7-5 Low-Temperature Limit Control
 - 7-6 Defrost Operation
 - 7-7 Current Limit Control
 - 7-8 One-Touch Comfort
 - 7-9 Hi POWER Mode
 - 7-10 QUIET Mode
 - 7-11 ECO Operation
 - 7-12 COMFORT SLEEP mode
 - 7-13 FILTER Check lamp
 - 7-14 Auto Restart Function
 - 7-15 Self-Cleaning function

8. INSTALLATION PROCEDURE

- 8-1 Safety Cautions
- 8-2 Installation Diagram of Indoor and Outdoor Units
- 8-3 Installation
- 8-4 Indoor Unit
- 8-5 Outdoor Unit
- 8-6 How to Set Remote Control Selector Switch
- 8-7 Others

9. TROUBLESHOOTING CHART

- 9-1 Troubleshooting Procedure
- 9-2 Basic Check Items
- 9-3 Primary Judgement
- 9-4 Self-Diagnosis by Remote Control (Check Code)
- 9-5 Troubleshooting Flowcharts
- 9-6 Troubleshooting for Remote Control

10. PART REPLACEMENT

- 10-1 Indoor Unit
- 10-2 Outdoor Unit

11. EXPLODED VIEWS AND PARTS LIST

- 11-1 Indoor Unit (E-Parts Assy)
- 11-2 Indoor Unit
- 11-3 Outdoor Unit (RAS-10S2AH-ES)
- 11-4 Outdoor Unit (RAS-10SA-ES)

1. SPECIFICATIONS

ITEM		MODEL	RAS-10SKHP-ES / RAS-10S2AH-ES				RAS-10SKP-ES / RAS-10SA-ES	
			Cooling		Heating		Cooling	
Capacity	kW	220V	240V	220V	240V	220V	240V	
		2.73	2.73	2.92	2.96	2.73	2.73	
Power source	Phase	1Ø □						
	V	220 – 240						
	Hz	50						
Power consumption	kW	0.83	0.85	0.79	0.82	0.83	0.85	
Power factor	%	98	97	97	96	98	97	
Running current	Indoor	0.15						
	Outdoor	3.71	3.50	3.55	3.40	3.71	3.50	
Starting current	A	18						
Moisture removal	lit/h	1.2						
Noise	Indoor (H/M+/M/L+/L) dB	39/37/35/33/31						
	Outdoor (220-240V) dB	47	49	47	49	46	47	
Refrigerant	Name of refrigerant	R410A						
	Rated amount kg	0.78				0.72		
Refrigerant control		Capillary tube						
Interconnection pipe	Gas side size mm	Ø 9.52						
	Connection type	Flare connection						
	Liquid side size mm	Ø 6.35						
	Connection type	Flare connection						
	Maximum length (One way) m	10*1						
	Maximum height difference m	5						
INDOOR UNIT			RAS-10SKHP-ES			RAS-10SKP-ES		
Dimensions	Height mm	250						
	Width mm	740						
	Depth mm	195						
Net weight	kg	8						
Evaporator type		Finned tube						
Indoor fan type		Cross flow fan						
Air volume	High fan m³/h	540		560		540		
	Medium fan m³/h	460		500		460		
	Low fan m³/h	390		400		390		
Fan motor output	W	20						
Air filter		Honeycomb woven filter with PP frame						
OUTDOOR UNIT			RAS-10S2AH-ES			RAS-10SA-ES		
Dimensions	Height mm	550						
	Width mm	780						
	Depth mm	290						
Net weight	kg	31			30			
Condenser type		Finned tube						
Outdoor fan type		Propeller fan						
Airflow volume	m³/h	2030	2150	2030	2150	1740	1850	
Fan motor output	W	30				20		
Compressor	Model	PA108X1C-4FZDN						
	Output W	750						
Safety device		Fuse, Overload relay						
Louver type		Automatic louver						
Usable outdoor temperature range	°C	15 ~ 43		-10 ~ 24		15 ~ 43		

Note : 1

- Capacity is based on the following temperature conditions.

		Condition	JIS C9612	
			Cooling	Heating
Indoor unit inlet air temperature	(DB)		27°C	20°C
	(WB)		19°C	15°C
Outdoor unit inlet air temperature	(DB)		35°C	7°C
	(WB)		24°C	6°C

Note : 2

*1 No need to change extra refrigerant.

2. CONSTRUCTION VIEWS

2-1. Indoor Unit

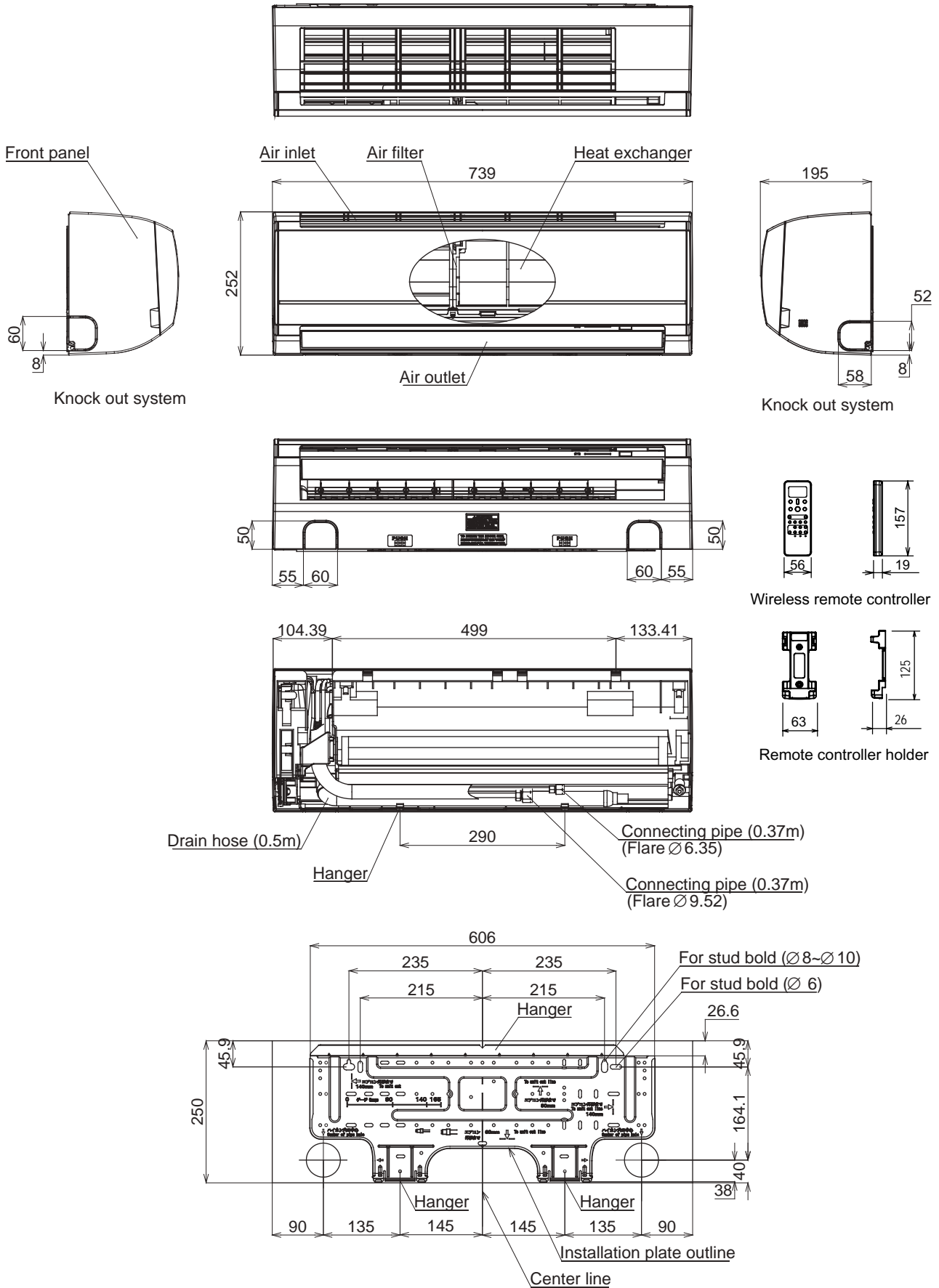

2.2. Outdoor Unit

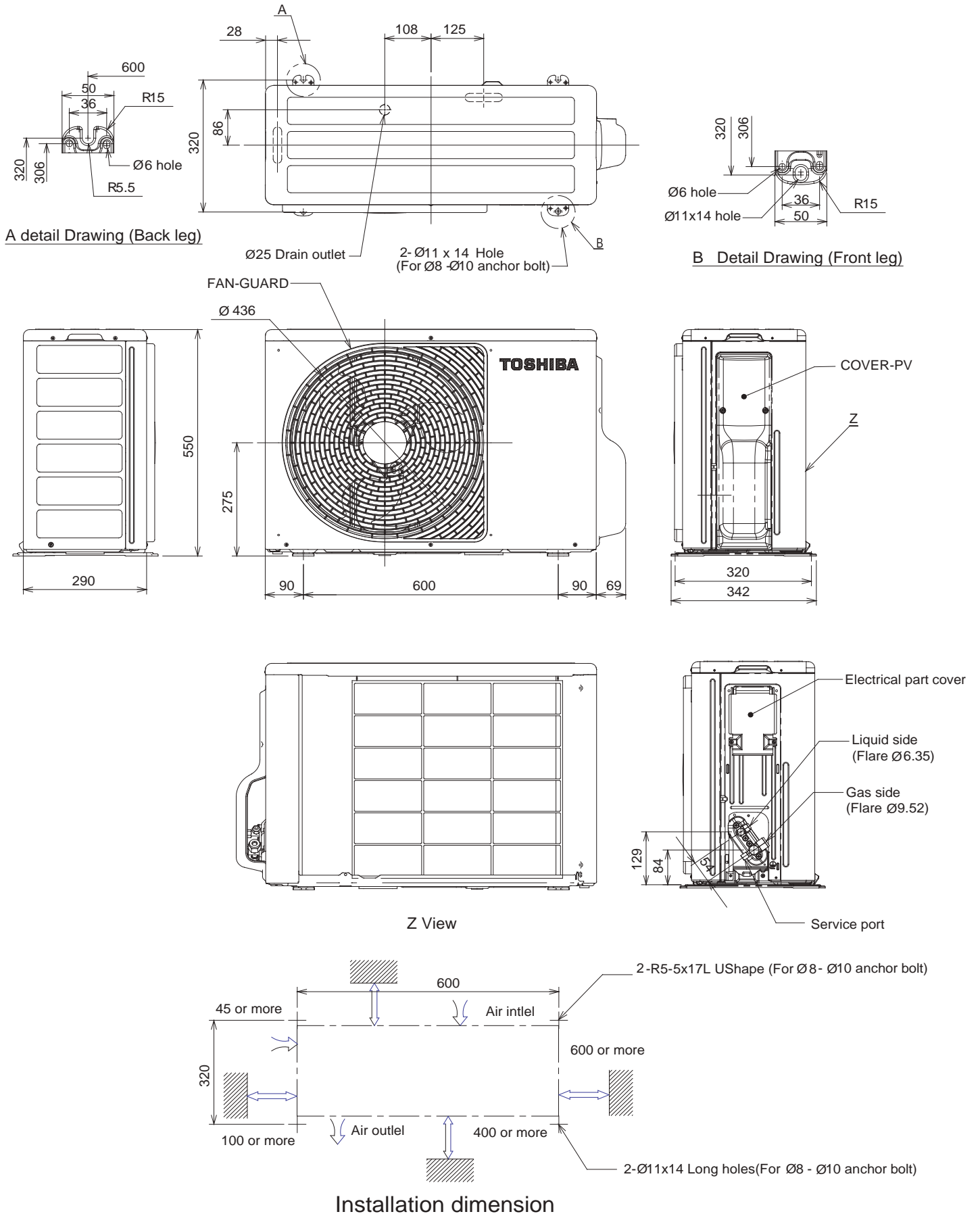

3-2. RAS-10SKP-ES / RAS-10SA-ES

POWER SUPPLY
(From main line)
1Ø 220-240V
~50Hz

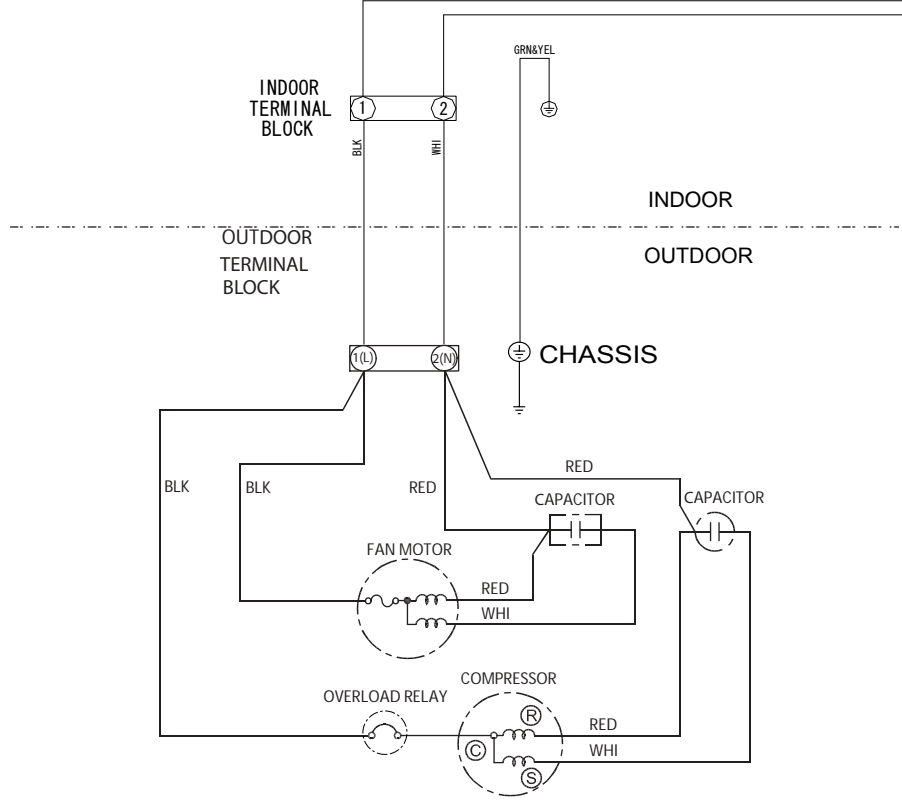
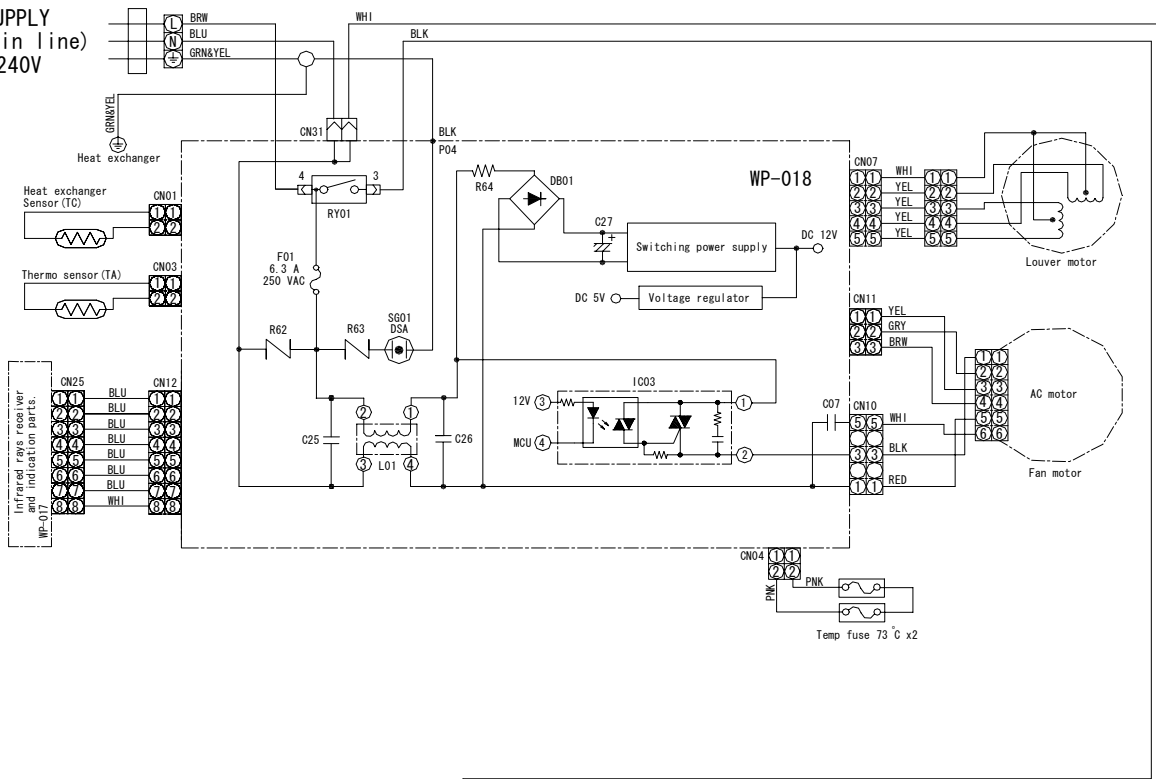

4. SPECIFICATION OF ELECTRICAL PARTS

4-1. Indoor Unit (RAS-10SKHP-ES)

No.	Parts name	Type	Specifications
1	Fan motor (for indoor)	AFN-220-20-4D	AC Motor with 145 °C thermo fuse
2	Thermo sensor (TA-sensor)		10k Ω at 25°C
3	Micro power module (M01)	μ RM1260V	
4	Microcontroller unit (IC30)	TMP87CM40AFG-6P69	
5	Heat exchanger sensor (TC-sensor)		10k Ω at 25°C
6	Line filter (L01)	LC*SS11V-R06270	27mH, 600mA
7	Bridge rectifier (DB01)	DB105G	1A, 600 V
8	Capacitor (C63)	EKMH401VSN470MP20S	47 μ F, 400 V
9	Fuse (F01)	BET6.3A	6.3A, 250VAC
10	Varistor (R21, R22)	SR561K14DL	560 V
11	Resistor (R319)	RF-2TK5R6	5.6 Ω , 2 W
12	Louver motor	MP24ZCT	12VDC
13	Relay (Comp., RY01)	G4A-1A-E-CA	Rating 20A/AC250 V, 12VDC
14	Relay (Fan, RY03)	G5NB-CA	Rating 3A/AC250 V, 12VDC
15	Relay (Solenoid, RY04)	G5NB-1A	Rating 3A/AC250 V, 12VDC

4-2. Outdoor Unit (RAS-10S2AH-ES)

No.	Parts name	Type	Specifications
1	Compressor	PA108X1C-4FZDN	Output (Rated) 750W , 2poles, 1 phase, 220 – 240V, 50Hz
			Winding resistance (Ω) (at 20°C)
2	Fan motor (for outdoor)	WLF-240-30A	Output (Rated) 30W, 6poles, 1 phase, 220 – 240V, 50Hz
			Winding resistance (Ω) (at 20°C)
3	Running capacitor (for fan motor)	DS451155NPQB	AC 450V~, 1.5 μ E
4	Running capacitor (for compressor)	RS44B256U0213S	AC 440V~, 25 μ E
5	Solenoid coil (for 4-way valve)	–	AC 220 – 240V
6	Overload relay	LPAP960B	U/T: 6.1A(80°C), Open: 135 \pm 5°C, Close: 78 \pm 11°C

4-3. Indoor Unit (RAS-10SKP-ES)

No.	Parts name	Type	Specifications
1	Fan motor (for indoor)	AFN-220-20-4D	AC Motor with 145 °C thermo fuse
2	Thermo sensor (TA-sensor)		10k Ω at 25°C
3	Switching transformer	ST-02	
4	Microcontroller unit (IC30)	TMP87CM40ANG-6P68	
5	Heat exchanger sensor (TC-sensor)		10k Ω at 25°C
6	Line filter (L01)	LC*SS11V-R06270	27mH, 600mA
7	Capacitor (C27)	EKMH401VSN470MP20S	47 μ F, 400 V
8	Fuse (F01)	BET6.3A	6.3A, 250VAC
9	Varistor (R62, R63)	SR561K14DL	560 V
10	Resistor (R64)	RF-2TK5R6	5.6 Ω , 2 W
11	Louver motor	MP24ZCT	12VDC
12	Relay (Comp., RY01)	G4A-1A-E-CA	Rating 20A/AC250 V, 12VDC

4-4. Outdoor Unit (RAS-10SA-ES)

No.	Parts name	Type	Specifications		
1	Compressor	PA108X1C-4FZDN	Output (Rated) 750W, 2poles, 1 phase, 220 – 240V, 50Hz		
			Winding resistance (Ω) (at 20°C)	C-R	C-S
				3.75	4.75
2	Fan motor (for outdoor)	SKF-240-20B	Output (Rated) 20W, 6poles, 1 phase, 220 – 240V, 50Hz		
			Winding resistance (Ω) (at 20°C)	Red-Black	White-Black
				235.2	260.1
3	Running capacitor (for fan motor)	DS451155NPQB	AC 450V~, 1.5 μ F		
4	Running capacitor (for compressor)	B32332I5256J063	AC 450V~, 25 μ F		
5	Overload relay	LPAP960B	U/T: 6.1A(80°C), Open: 135 \pm 5°C, Close: 78 \pm 11°C		

5. REFRIGERATION CYCLE DIAGRAM

5-1. RAS-10SKHP-ES / RAS-10S2AH-ES

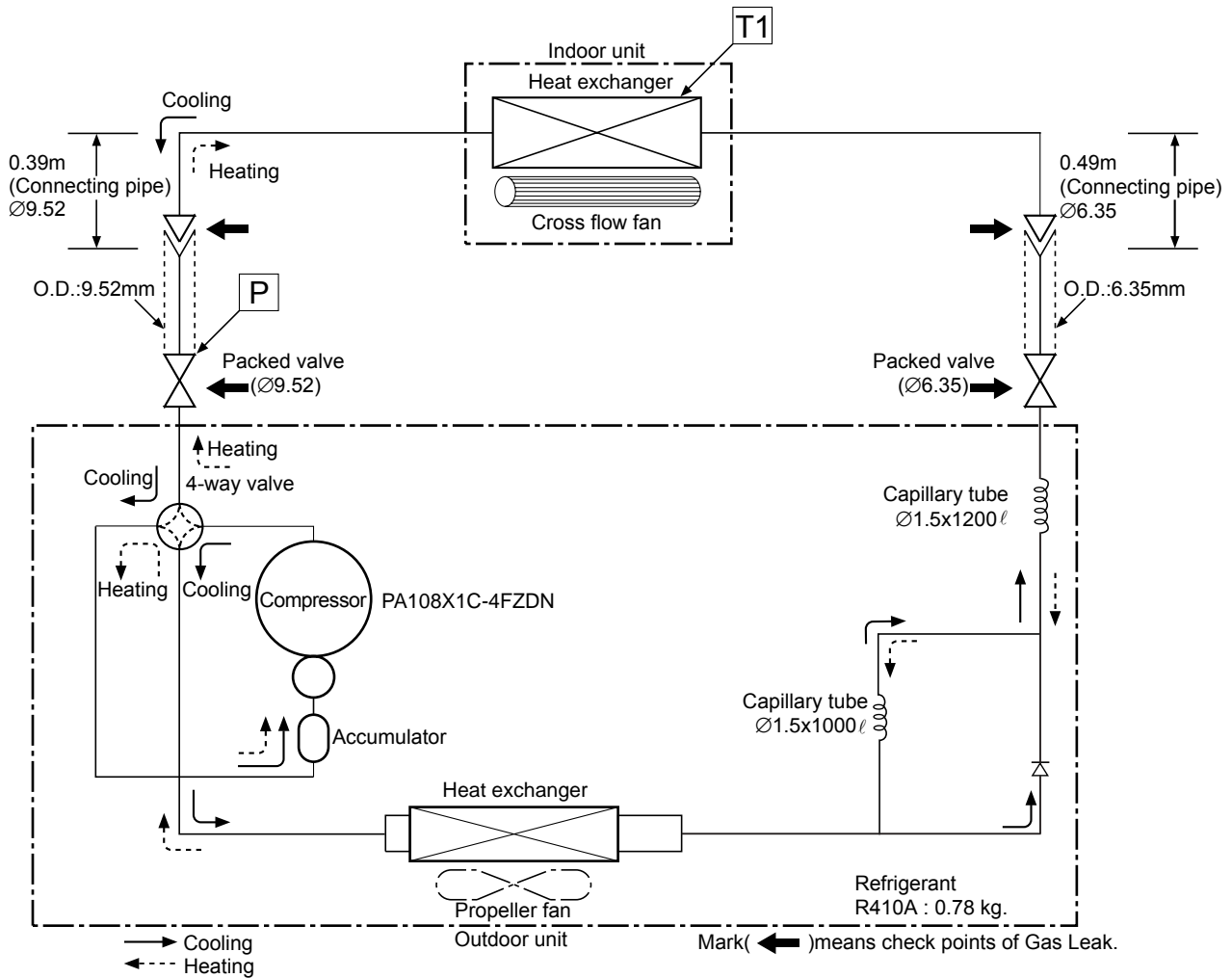

50Hz		Standard pressure [P] (MPaG)	Surface temp. of heat exchanger inter changing pipe [T1] (°C)	Fan speed (indoor)	Ambient temp. conditions DB/WB (°C)	
					Indoor	Outdoor
Heating	Standard	2.95	43.5	High	20/15	7/6
	Overload	3.70	57.0	Low	27/-	24/18
	Low temperature	2.40	32.0	High	20/-	-10/-10
Cooling	Standard	0.93	10.5	High	27/19	35/24
	Overload	1.08	15.0	High	32/23	43/26
	Low temperature	0.69	2.0	Low	21/15	21/15

Note :

- Measure the heat exchanger temperature at the center of U-bend. (By means of TC sensor)

5-2. RAS-10SKP-ES / RAS-10SA-ES

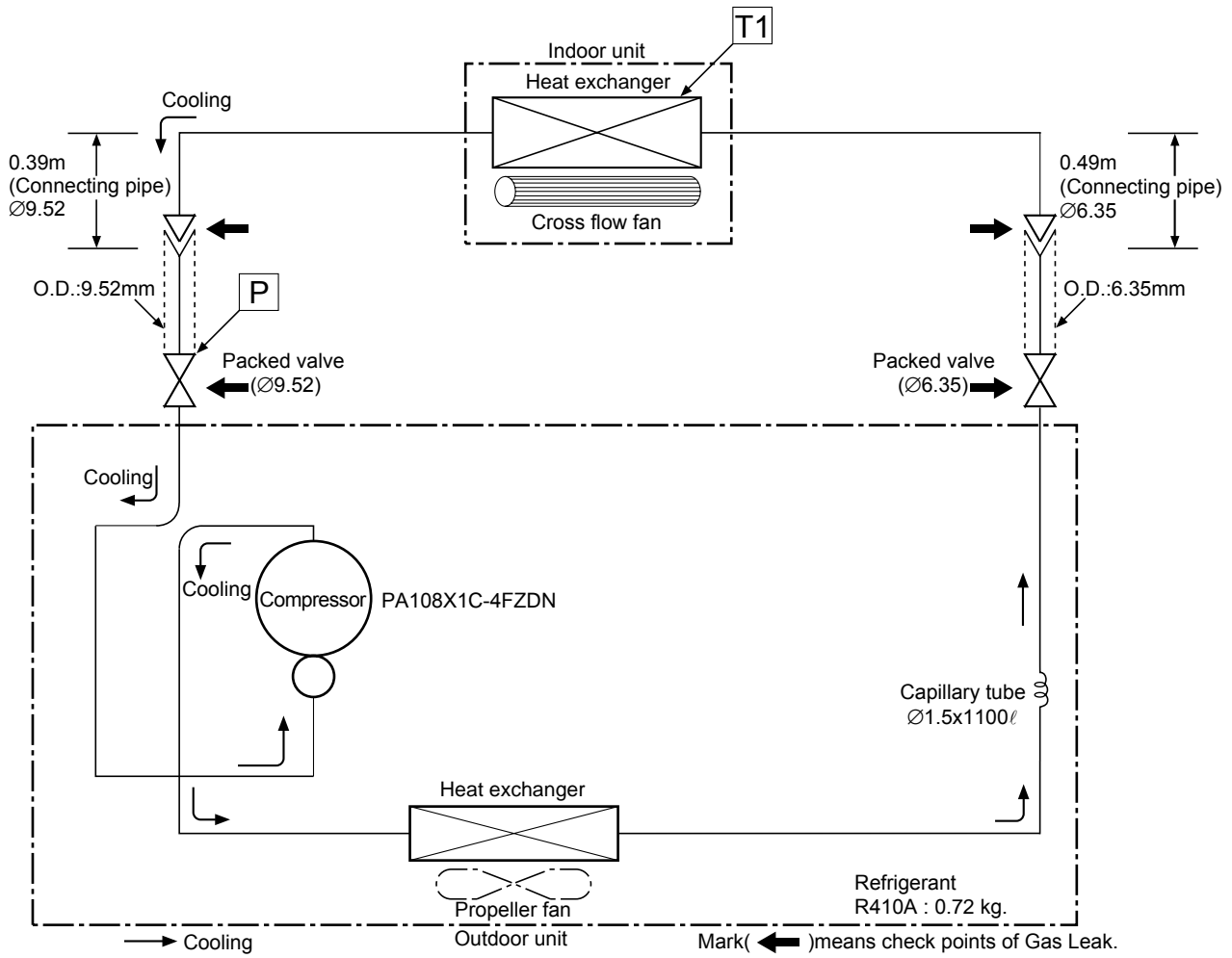

50Hz		Standard pressure P (MPaG)	Surface temp. of heat exchanger interchanging pipe T1 (°C)	Fan speed (indoor)	Ambient temp. conditions DB/WB (°C)	
					Indoor	Outdoor
Cooling	Standard	0.95	10.5	High	27/19	35/24
	Overload	1.12	16.0	High	32/23	43/26
	Low temperature	0.71	2.0	Low	21/15	21/15

Note :

- □ Measure the heat exchanger temperature at the center of U-bend. (By means of TC sensor)

6. CONTROL BLOCK DIAGRAM

6-1. RAS-10SKHP-ES / RAS-10S2AH-ES

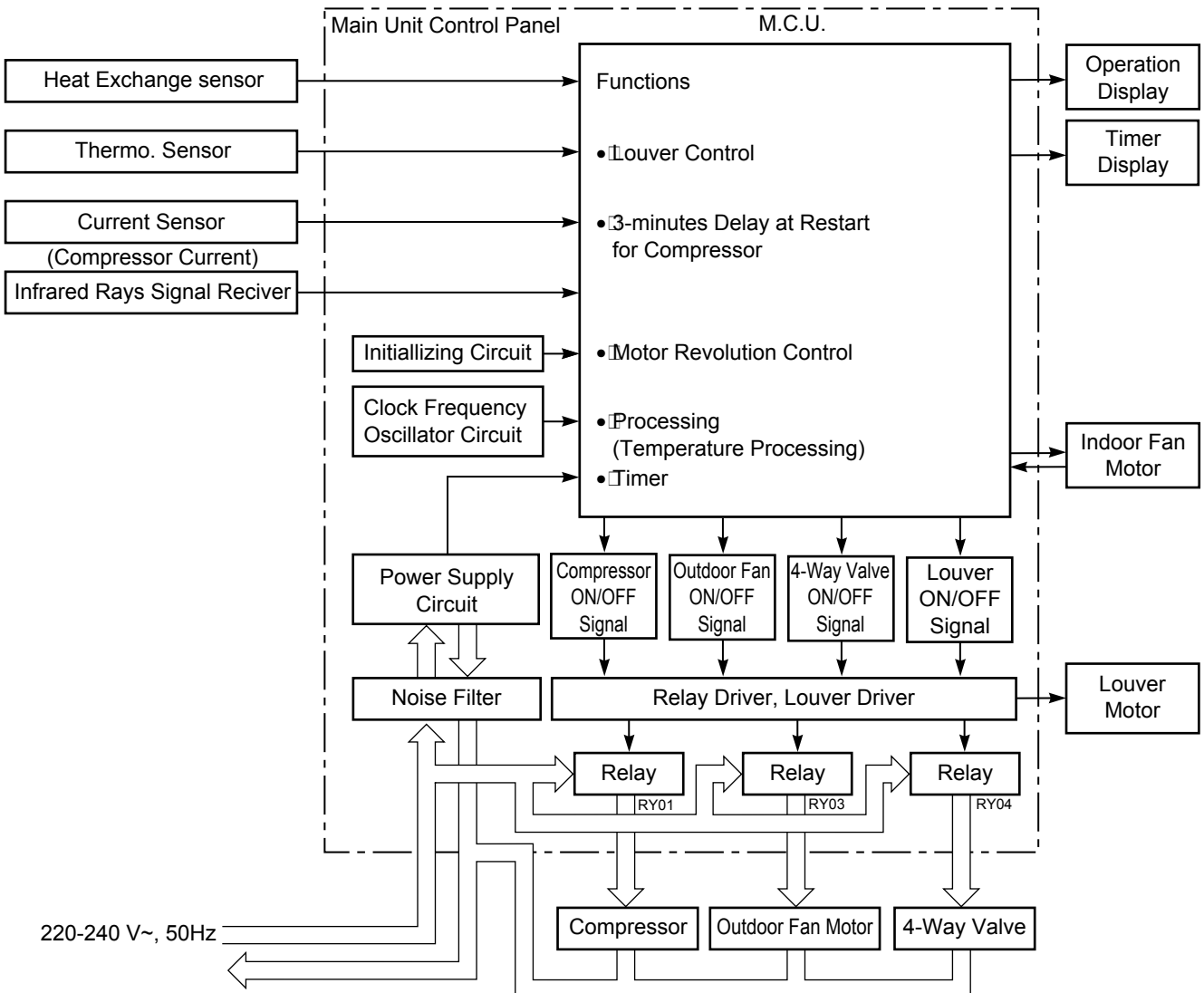

REMOTE CONTROL

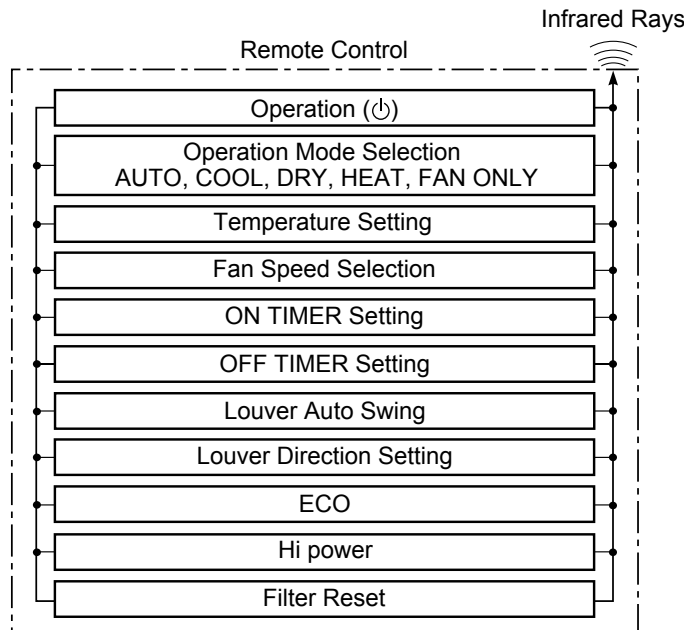

6-2. RAS-10SKP-ES / RAS-10SA-ES

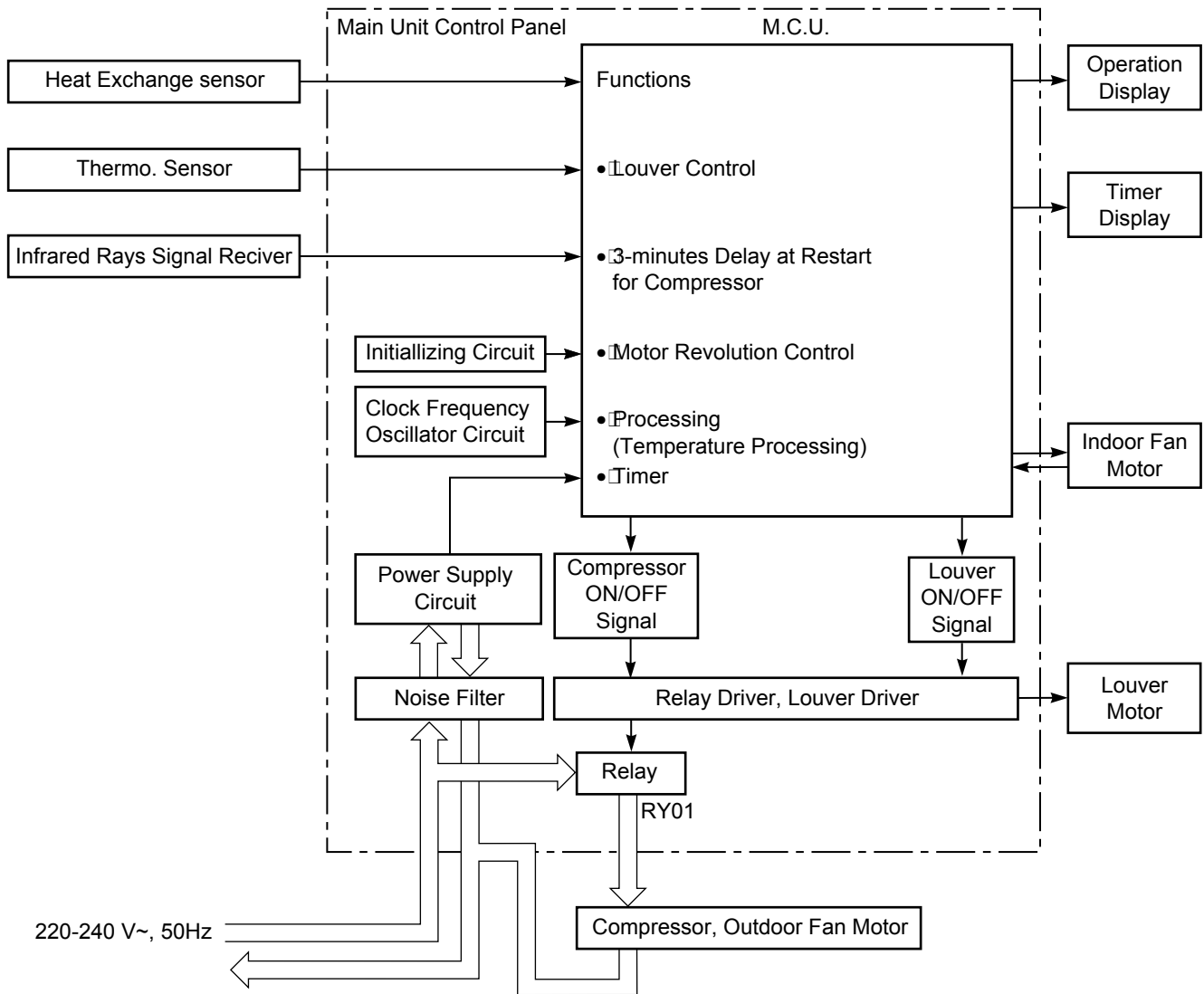

REMOTE CONTROL

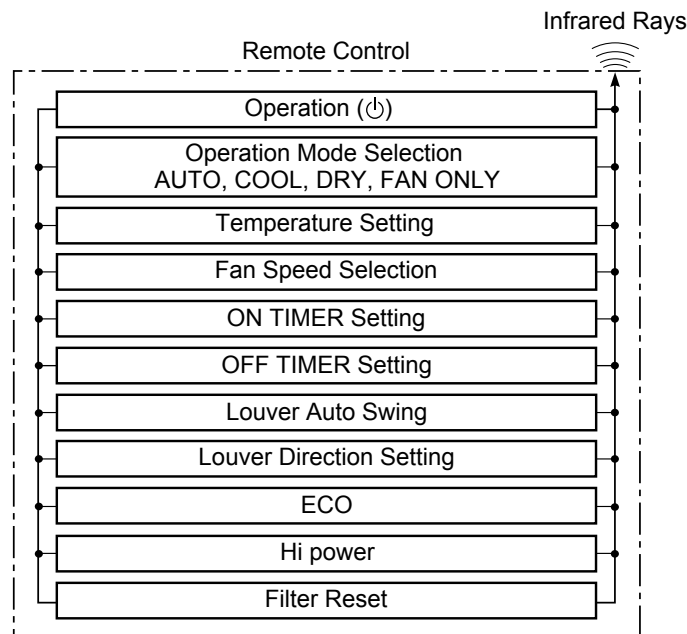

7. OPERATION DESCRIPTION

7-1. Remote control

7-1-1. Function of Push Button

- ① Infrared signal emitter
- ② Start/Stop button
- ③ Mode select button (MODE)
- ④ Temperature button (TEMP)
- ⑤ Fan speed button (FAN)
- ⑥ Swing louver button (SWING)
- ⑦ Set louver button (FIX)
- ⑧ On timer button (ON)
- ⑨ Off timer button (OFF)
- ⑩ Sleep timer button (SLEEP)
- ⑪ Timer setup button (SET)
- ⑫ Timer clear button (CLR)
- ⑬ Memory and Preset button (PRESET)
- ⑭ One Touch button (ONE-TOUCH)
- ⑮ High power button (Hi-POWER)
- ⑯ Economy button (ECO)
- ⑰ Quiet button (QUIET)
- ⑱ Comfort sleep button (COMFORT SLEEP)
- ⑲ Filter reset button (FILTER)
- ⑳ Clock Reset button (CLOCK)
- ㉑ Check button (CHK)

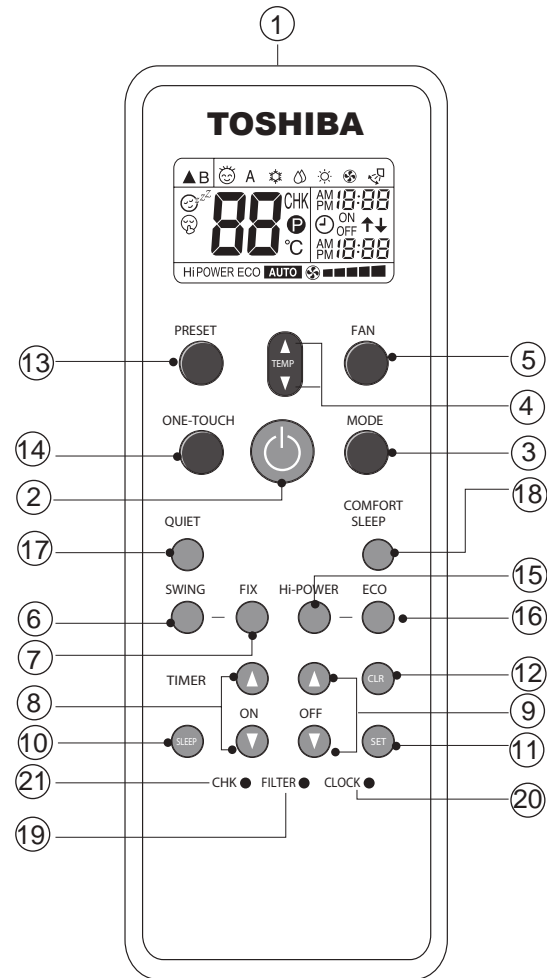





7-1-2. Display of Remote Control

All indications, except for the clock time indicator, are displayed by pressing the  button.

1. Transmission mark

This transmission mark  indicates when the remote controller transmits signals to the indoor unit.







2. Mode indicator

Indicates the current operation mode.
(AUTO : Automatic control, A : Auto changeover control,  : Cool,  : Dry,  : Heat,  : Fan only)

3. Temperature indicator

Indicates the temperature setting.
(17°C to 30°C)

4. FAN speed indicator

Indicates the selected fan speed.
AUTO or five fan speed levels
(LOW , LOW+ , MED , MED+ , HIGH ) can be shown.
Indicates AUTO when the operating mode is either AUTO or  : Dry.

5. TIMER and clock time indicator

The time setting for timer operation or the clock time is indicated.
The current time is always indicated except during TIMER operation.

6. Hi-POWER indicator

Indicates when the Hi-POWER operation starts.
Press the Hi-POWER button to start and press it again to stop the operation.

7. (PRESET) indicator

Flashes for 3 seconds when the PRESET button is pressed during operation.
The  mark is shown when holding down the button for more than 3 seconds while the mark is flashing.
Press another button to turn off the mark.

8. ECO indicator

Indicates when the ECO is in activated.
Press the ECO button to start and press it again to stop operation.

9. A, B change indicator remote controller

When the remote controller switching function is set, "B" appears in the remote controller display.
(When the remote controller setting is "A", there is no indication at this position.)

10. Comfort sleep

Indicates when comfort sleep is activated.
Press comfort sleep button to selecter

11. Quiet

Indicates when quiet is activated.
Press quiet button to start and press it again to stop operation.

12. One-Touch

Indicates when one touch comfort is activated.
Press one-touch button to start the operation.

13. Swing

Indicates when louver is swing.
Press swing button to start the swing operation and press it again to stop the swing operation.

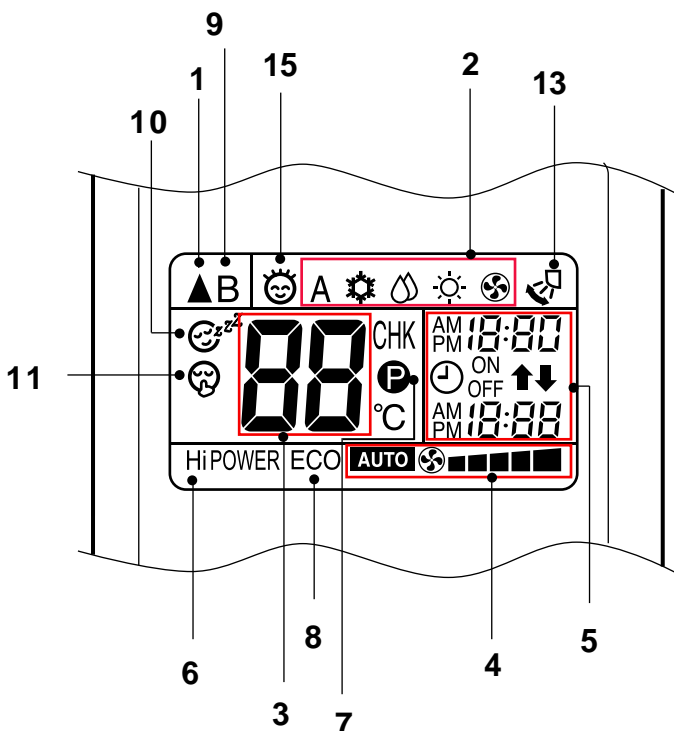

7-2. Outline of Air Conditioner Control

This is a fixed capacity type air conditioner, which uses a AC motor for an indoor fan. The AC motor drive circuit is mounted in the indoor unit. And electrical parts which operate the compressor and the outdoor fan motor, are mounted in the outdoor unit.

The air conditioner is mainly controlled by the indoor unit controller. The controller operates the indoor fan motor based upon commands transmitted by the remote control and transfers the operation commands to the outdoor unit controller.

The outdoor unit receives operation commands from the indoor unit, and operates the outdoor fan motor and the compressor.

(1) Role of indoor unit controller

The indoor unit controller receives the operation commands from the remote control and executes them.

- Temperature measurement at the air inlet of the indoor heat exchanger by the indoor temperature sensor
- Temperature measurement of the indoor heat exchanger by the heat exchanger sensor
- Louver motor control
- Indoor fan motor operation control
- LED display control
- Transferring of operation commands to the outdoor unit
- Receiving of information of the operation status and judging of the information or indication of error

(2) Role of outdoor unit controller

The outdoor unit controller receives the operation commands from the indoor controller and executes them.

- Compressor operation control
 - Operation control of outdoor fan motor
- } Operations according to the commands from the indoor unit

- Turning off the compressor and outdoor fan when the outdoor unit receives the shutdown command
- Defrost control in heating operation (Temperature measurement by the indoor heat exchanger and control for the four-way valve and the outdoor fan motor) *Heat pump Model only

7-2-1. Louver control

(1) Vertical air flow louver

Position of vertical air flow louver is automatically controlled according to the operation mode.

Besides, position of vertical air flow louver can be arbitrarily set by pressing [FIX] button.

The louver position which is set by [FIX] button is stored in the microcomputer, and the louver is automatically set at the stored position for the next operation.

(2) Swing

If [SWING] button is pressed when the indoor unit is in operation, the vertical air flow louver starts swinging. When [SWING] button is pressed, it stops swinging.

7-2-2. Indoor Fan Control

The operation controls the fan speed at indoor unit side. The indoor fan (cross flow fan) is operated by the phase control induction motor. The fan rotates in 5 stages in MANUAL model, and in 5 stages in AUTO mode, respectively. (Table 7-2-1)

- 1) When setting the fan speed to L, L+, M, M+ or H on the remote controller, the operation is performed with the constant speed shown in Fig. 7-2-1 and Fig 7-2-2

Fig (7-2-1) Cooling

Indication	Fan speed
L	Low
L+	(L + M) / 2
M	Med
M+	(M + H) / 2
H	High

Fig (7-2-2) Heating

Indication	Fan speed
L	Low
L+	(L + M) / 2
M	Med
M+	(M + H) / 2
H	High

- 2) When setting the fan speed to AUTO on the remote controller, revolution of the fan motor is controlled to the fan speed level shown in Table 1 according to the setup temperature, room temperature, and heat exchanger temperature.

Table 7-2-1 Indoor fan and air flow rate

OPERATION MODE		FAN TAP															
		Cool			UH	H	M+		M		L+	L	L-	UL	SUL		
Model	RAS-10SKHP-ES	fan speed (rpm)	1350	1350	1350	1300	1250	1180	1140	1000	980	980	900	800	750	700	550
		Air flow (m3/h)	560	560	560	540	510	500	460	400	390	390	350	300	270	250	180
	RAS-10SKP-ES	fan speed (rpm)	1350	1350	1350	1300	1250	1180	1140	1000	980	980	900	800	750	700	550
		Air flow (m3/h)	560	560	560	540	510	500	460	400	390	390	350	300	270	250	180

7-3. Description of Operation Mode

- (1) When turning on the breaker, the operation lamp blinks. This means that the power is on (or the power supply is cut off.)
- (2) When pressing [⏻] button on the remote control, receiving beep sounds from the indoor unit, and the next operation is performed together with opening the vertical air flow louver.
- (3) Once the operation mode is set, it is memorized in the microcomputer so that the previous operation can be effected thereafter simply by pressing [⏻] button.

7-3-1. Fan only operation

([MODE] button on the remote control is set to the fan only operation.)

- (1) When [FAN] button is set to AUTO, the indoor fan motor operates as shown in Fig. 7-3-3. When [FAN] button is set to LOW, LOW⁺, MED, MED⁺ or HIGH, the motor operates with a constant air flow.

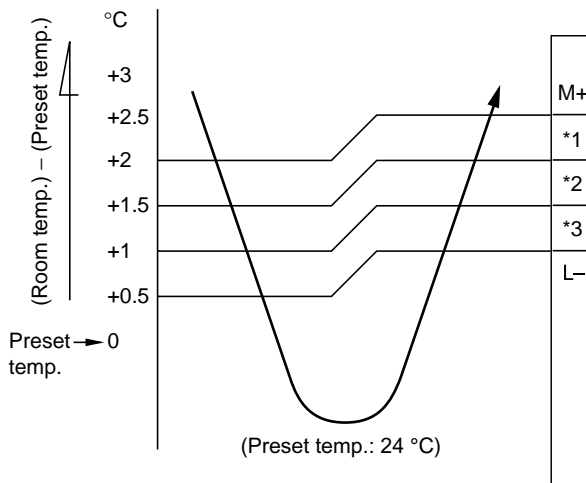

- NOTE1 :** *1 : Fan speed = $(M + -L) \times 3/4 + L$
 *2 : Fan speed = $(M + -L) \times 2/4 + L$
 *3 : Fan speed = $(M + -L) \times 1/4 + L$

(Linear approximation from M+ and L)

NOTE2 : The Hi Power, ECO and COMFORT SLEEP operation can not be set

Fig. 7-3-3 Setting of air flow [FAN:AUTO]

7-3-2. Cooling operation

([MODE] button on the remote control is set to the cooling operation.)

- (1) The compressor, 4-way valve, outdoor fan and operation display lamp are controlled as shown in Fig. 7-3-4.

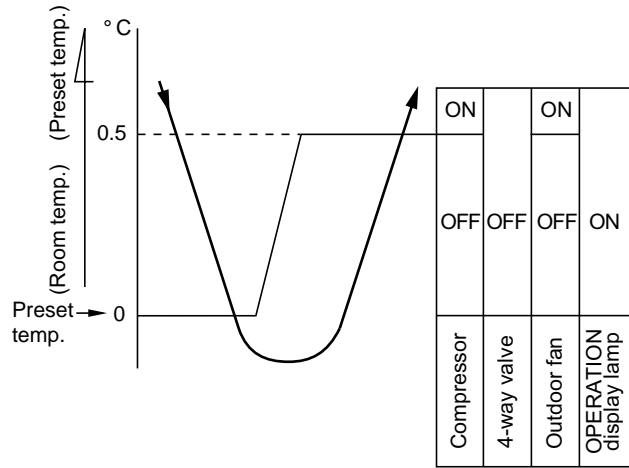
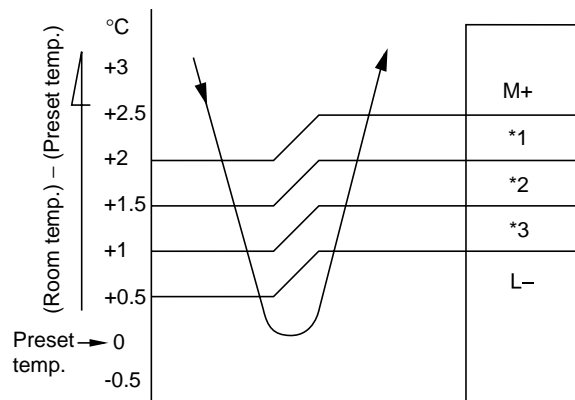

Fig. 7-3-4

- (2) When [FAN] button is set to AUTO, the indoor fan motor operates as shown in Fig. 7-3-5. When [FAN] button is set to LOW, LOW⁺, MED, MED⁺ or HIGH, the motor operates with a constant air flow.



- NOTE1 :** *1 : Fan speed = $(M + -L) \times 3/4 + L$
 *2 : Fan speed = $(M + -L) \times 2/4 + L$
 *3 : Fan speed = $(M + -L) \times 1/4 + L$

(Linear approximation from M+ and L)

Fig. 7-3-5 Setting of air flow [FAN:AUTO]

7-3-3. Dry operation
 ([MODE] button on the remote control is set to the dry operation.)

- (1) The compressor, 4-way valve, outdoor fan and operation display lamp are controlled as shown in Fig. 7-3-6.

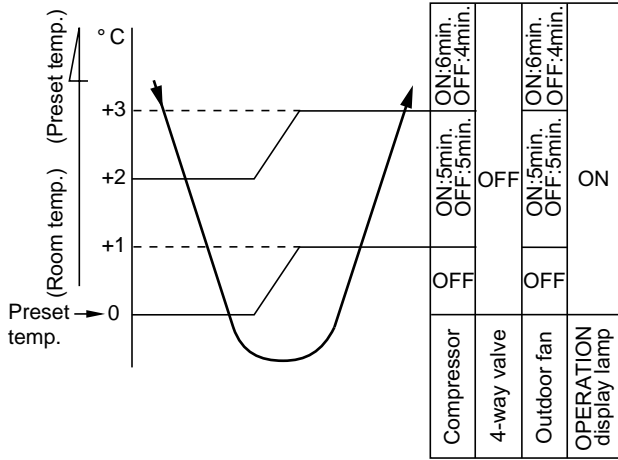

Fig. 7-3-6

- (2) The microprocessor turns the compressor on and off at the regular intervals (4 to 6 minutes). While the compressor is turning off, the indoor fan motor operates in the SUPER LOW position. The pattern of operation depending on the relation between room temperature and preset temperatures is shown in Fig. 7-3-7.

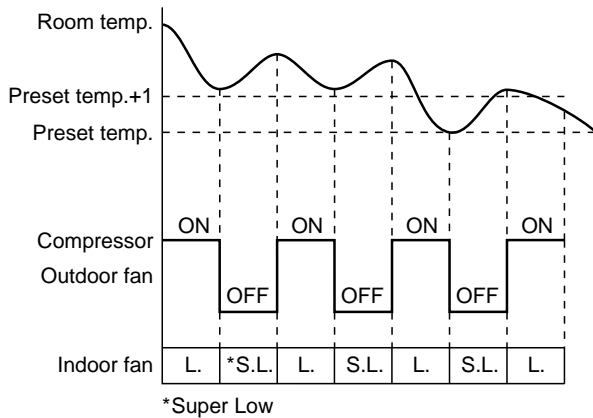

Fig. 7-3-7

- (3) [FAN] button on the remote control is set to AUTO only.
 (4) The ECO and Hi Power operations can not be set.

7-3-4. Heating operation
 ([MODE] button on the remote control is set to the heating operation.)

RAS-10SKHP-ES

- (1) The compressor, 4-way valve, outdoor fan and operation display lamp are controlled as shown in Fig. 7-3-8.

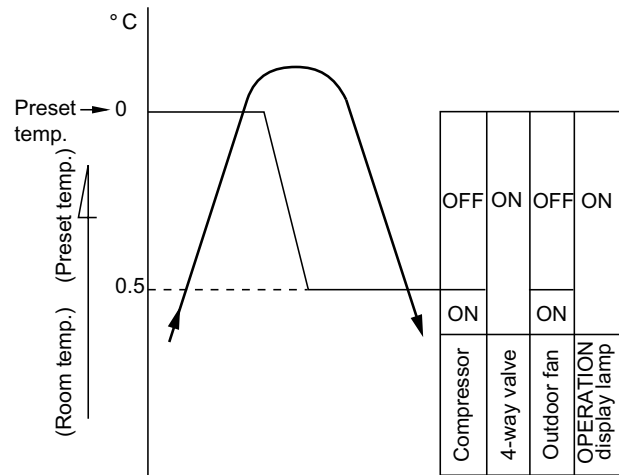
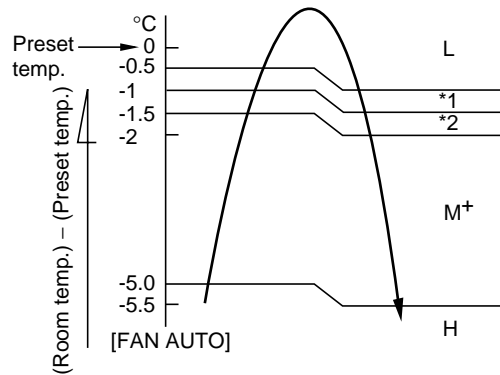

Fig. 7-3-8

- (2) When [FAN] button is set to AUTO, the indoor fan motor operates as shown in Fig. 7-3-9. When [FAN] button is set to LOW, LOW+, MED, MED+ or HIGH, the motor operates with a constant air flow.



*1 : Fan speed = (M + -L) x 1/4 + L

*2 : Fan speed = (M + -L) x 2/4 + L

*3 : Fan speed = (M + -L) x 3/4 + L

(Calculated with inear approximation from M+ and L+)

Fig. 7-3-9

- (3) The indoor heat exchanger restricts revolving speed of the fan motor to prevent a cold draft. The upper limit of the revolving speed is shown in Fig. 7-3-10 and Table 7-3-2.

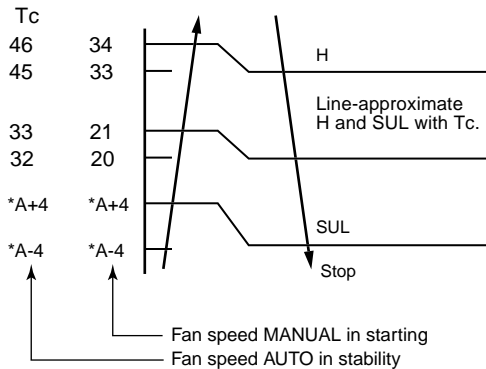

* No limitation while fan speed MANUAL mode is in stability.
 * A: When $T_{sc} \geq 24$, A is 24, and when $T_{sc} < 24$, A is T_{sc}
 Tsc: Set value

Fig. 7-3-10 Cold draft preventing control

Table 7-3-2

Fan speed	*5 Starting period	*6 Stabilized period
AUTO	<ul style="list-style-type: none"> Up until 12 minutes passed after starting the unit From 12 to 25 minutes passed after starting the unit and room temperature is 3°C lower than preset temperature 	<ul style="list-style-type: none"> From 12 to 25 minutes passed after starting the unit and room temperature is between preset temperature and 3°C lower than preset temperature 25 minutes or more passed after starting the unit
Manual (L – H)	<ul style="list-style-type: none"> Room temperature < Preset temperature -4°C 	<ul style="list-style-type: none"> Room temperature \geq Preset temperature -3.5°C

7-3-5. Automatic operation

([MODE] button on the remote control is set to the automatic operation.)

- One of 3 operations (Cooling, Fan only or Heating) is selected according to difference between the preset temperature and the room temperature at which the automatic operation has started, as shown in Fig. 7-3-11. The Fan only operation continues until the room temperature reaches a level at which another mode is selected.
- Temporary Auto
 When the RESET button on the indoor unit is pushed, the preset temperature is fixed at 24°C and the indoor unit is controlled as shown in Fig. 7-3-11.

RAS-10SKHP-ES

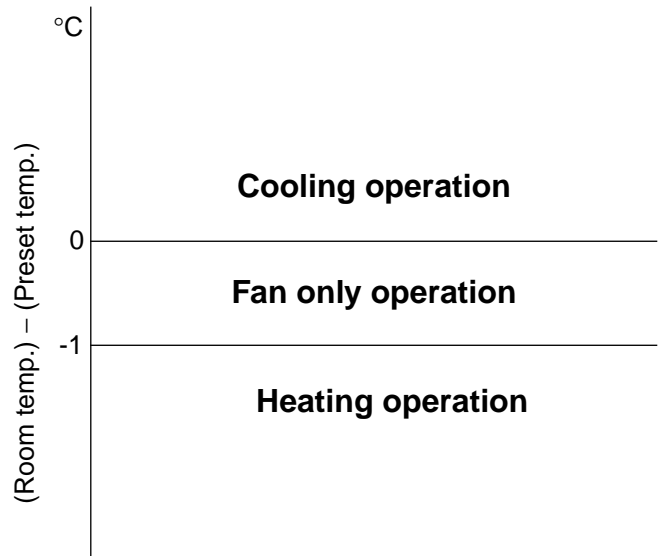

RAS-10SKP-ES

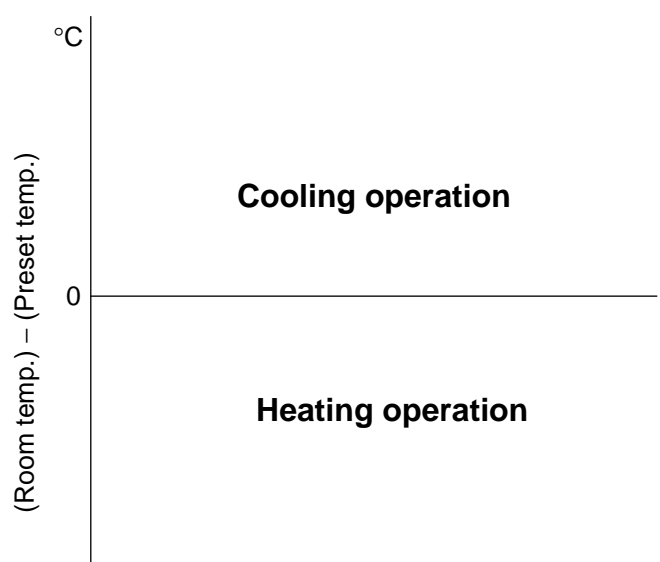

Fig. 7-3-11

7-4. High-Temperature Limit Control

*Heat pump model only

The microcontroller detects the indoor heat exchanger temperature to prevent pressure of a refrigerating cycle from increasing excessively.

The compressor and outdoor fan motor are controlled as shown in Fig. 7-4-1.

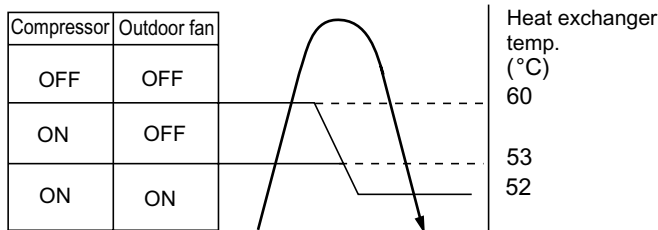

Fig. 7-4-1

7-5. Low-Temperature Limit Control

The microcontroller detects the indoor heat exchanger temperature to prevent the indoor heat exchanger from freezing.

The compressor and outdoor fan motor are controlled as shown in Fig. 7-5-1 and 7-5-2.

RAS-10SKHP-ES
RAS-10SKP-ES

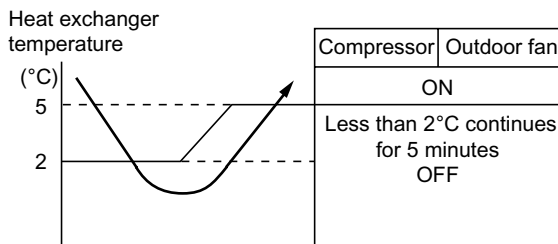

Fig. 7-5-1

7-6. Defrost Operation

*Heat pump model only

During the heating operation, the outdoor heat exchanger temperature goes down and sometimes it is frozen.

In this case, the air conditioner stops the heating operation and starts the defrost operation to melt ice.

7-6-1. Condition to start the defrost operation

The defrost operation starts whichever below conditions are satisfied.

- (1) When the cumulative compressor operating time is longer than 40 or 90 minutes and difference between the indoor heat exchanger temperature and the room temperature is less than the specified value. (This value is decided by the microprocessor.) (Control example is shown in Fig. 7-6-1. In case of B or C, the defrost operation starts.)
- (2) When the current limit control or the high temperature limit control is performed for total of 90 minutes.

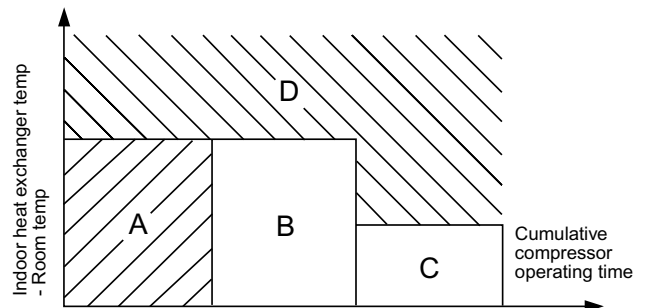

Fig. 7-6-1 (Indoor fan speed : M)

7-6-2. Defrost operation time control

<In case of B>

- (1) The heating operation is performed for at least 40 minutes.
- (2) The maximum defrost operating time is 6 minutes. The defrost operating time for the 4th cycle is 10 minutes. (When the outdoor temperature is very low, however, the defrost operating time is 10 minutes.)

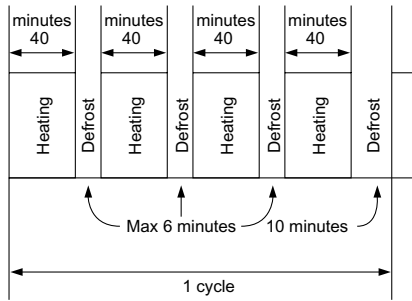

Fig. 7-6-2

<In case of C>

- (1) The heating operation is performed for at least 90 minutes.
- (2) The defrost operating time is 10 minutes.

7-6-3. Ending condition at defrost operation

- (1) When the compressor current becomes 8.0A or more during defrost operation, the defrost operation stops and the heating operation restarts. (The current sensor detects the compressor current.)
- (2) The defrost operation continues for at most 6 minutes or 10 minutes.

7-7. Current Limit Control

The microcontroller detects the input current so as to prevent it exceeds a specified value by means of controlling the outdoor fan control as described in (1) and (2).

(1) Current limit control (Cooling operation)

Control is performed as shown below by detecting the compressor operating current with a current sensor (C.T).

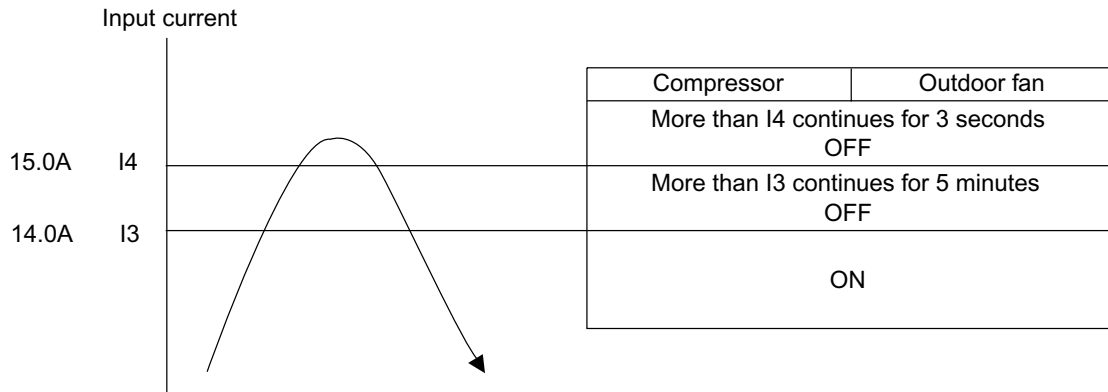

Fig. 7-7-1

(2) Current limit control (Heating operation)

Control is performed as shown in Fig. 7-7-2

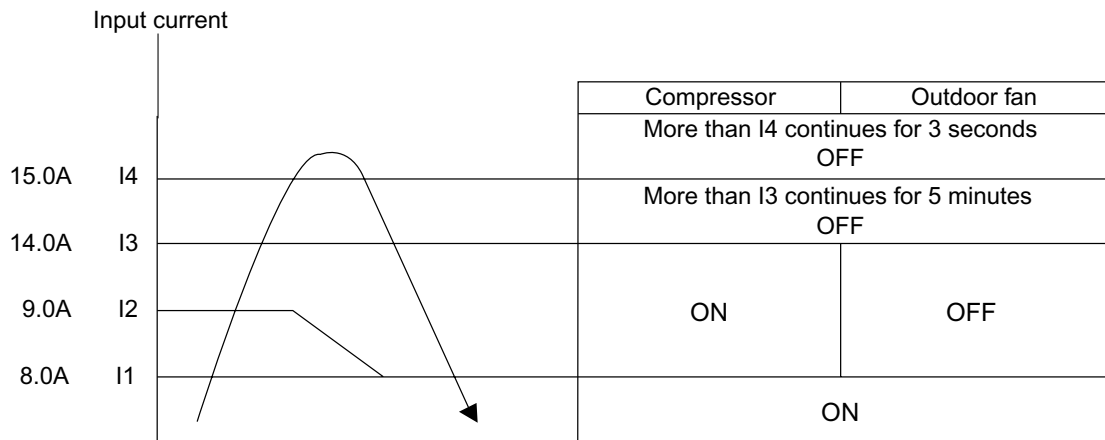

Fig. 7-7-2

Remark :

1. This function is available only for heat pump model (Cooling models have no a current sensor (C.T)).

7-8. One-Touch Comfort

One touch comfort is the fully automated operation that is set according to the preferable condition in a region.

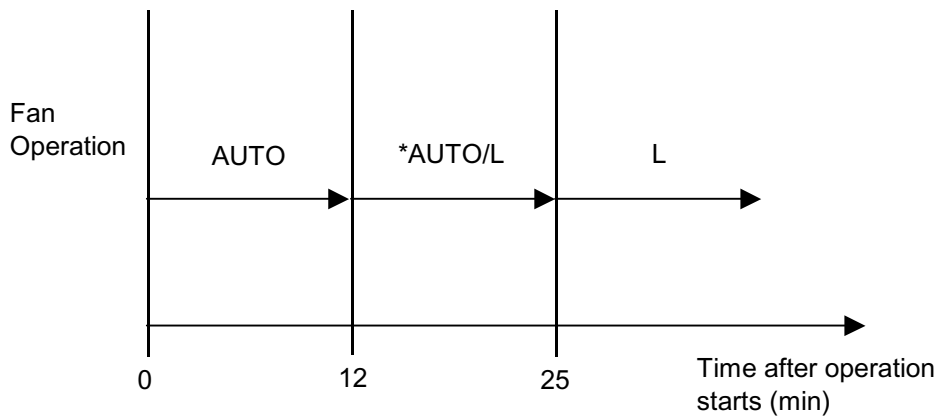

*AUTO/L : Fan operates depends on the setting temperature and room temperature.

During the One Touch Comfort mode if the indoor unit receives any signal with other operation mode, the unit will cancel the comfort mode and operates according to the signal received.

Operation description

When an indoor unit receives "One Touch Comfort Signal" from the remote controller, the indoor unit operates as following.

- 1) Air conditioner starts to operation when the signal is received, even if the air conditioner was OFF.
- 2) Operation mode is set according to room temperature, the same as AUTO mode.
- 3) Target temperature is 24°C (for Heat pump model) and 22°C (for cooling only model).
- 4) Louver position is set as stored position.
- 5) Fan is controlled as diagram.

7-9. Hi POWER Operation ([Hi POWER] button on the remote control is pressed.)

When [Hi POWER] button is pressed while the indoor unit is in Auto, Cooling or Heating operation, Hi POWER mark is indicated on the display of the remote control and the unit operates as follows.

- (1) Automatic operation
 - The indoor unit operates in according to the current operation.
- (2) Cooling operation
 - The setting temperature drops 3°C. (The value of the setting temperature on the remote control does not change.)
 - If the room temperature is higher than the setting temperature by 3.5°C or more, the horizontal louver moves to the Hi POWER position automatically. Then when the room temperature is 1°C less than the setting temperature the horizontal louver returns automatically.
 - FAN speed : [AUTO]
 - If the room temperature is higher than the setting temperature by 3.5°C or more, the air conditioner operates at maximum airflow level. If the room temperature is higher than the setting temperature by less than 3.5°C, the air conditioner operates at normal airflow level.
 - FAN speed : One of 5 levels
 - If the room temperature is higher than the setting temperature by 3.5°C or more, the air conditioner operates at higher consecutive airflow level. If the room temperature is higher than the setting temperature by less than 3.5°C, the air conditioner operates at normal airflow level.
 - The indoor unit's fan speed level increase 1 tap
- (3) Heating operation
 - The preset temperature increases 2°C, (The value of the preset temperature on the remote control does not change.)
 - The indoor unit operates in normal heating mode except the preset temperature is higher (+2°C).
 - The indoor unit's fan speed level increase 1 tap
- (4) The Hi POWER mode can not be set in Dry or Fan only operation.
- (5) The Hi POWER mode can memorize with timer function.

7-10. QUIET Operation

When the [QUIET] button is pressed, the fan of the indoor unit will be restricted the revolving speed at speed L– until the [QUIET] button is pressed once again (cancel Quiet mode).

Quiet mode is the system which, control the revolving speed of indoor fan to work constantly at lower than speed L. In addition, noise level of indoor unit is less than usual.

Remarks :

1. Quiet mode is unable to work in dry mode.
2. Quiet mode is appropriate to work with less cooling load and less heating load condition. Because of the fan speed L– may cause not enough the cooling capacity or heating capacity.

7-11. ECO Operation.

Cooling operation

- The preset temperature will increase 1°C after the ECO mode has operated for 1 hour and the temperature will increase another 1°C after the ECO mode has operated for 2 hour. (the value of the preset temperature on the remote control does not change.)
- The indoor fan speed is depend on presetting and can change every speed after setting ECO operation.

Heating operation

- The preset temperature will drop down 1°C after the ECO mode has operated for 1 hour and the temperature will drop down another 1°C after the ECO mode has operated for 2 hour. (the value of the preset temperature on the remote control does not change.)
- The indoor fan speed is depend on presetting and can change every speed after setting ECO operation.

7-12. COMFORT SLEEP Operation

Cooling operation

- The preset temperature will increase 1°C after the comfort sleep mode has operated for 1 hour and the temperature will increase another 1°C after the comfort sleep mode has operated for 2 hour. (the value of the preset temperature on the remote control does not change)
- Press the [COMFORT SLEEP] button to select this function. The comfort sleep function will be activate together with Auto shut down function. Period of operation time can be select by re-press the [COMFORT SLEEP] button. The period of operation time are follows.

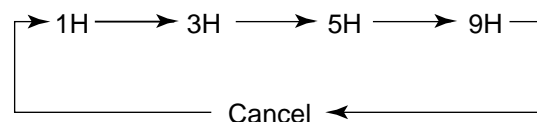

Heating mode

- The preset temperature will drop down 1°C after the comfort sleep mode has operated for 1 hour and the temperature will decrease another 1°C after the comfort sleep mode has operated for 2 hour. (The value of the preset temperature on the remote control does not change.)
- Press the [COMFORT SLEEP] button to select this function and period of operation time same as cooling mode operation.

The principles of comfort sleep mode are:

- Quietness for more comfortable. When room temperature reach setting temperature.
- Save energy by changing room temperature automatically.
- The air condition can shut down by itself automatically.

Remarks :

Comfort sleep mode will not operate in dry mode and fan only mode.

7-13. FILTER Check lamp

When the elapsed time reaches 1000 hours after air purifier operation, the FILTER indicator lights. After cleaning the filters, turn off the FILTER indicator.

How to Turn Off FILTER Indicator

Press [RESET] button on the indoor unit or press filter button on the remote control.

NOTE :

If [RESET] button is pushed while the FILTER indicator is not lit, the indoor unit will start the automatic operation.

When you want a temporary operation while the FILTER lamp lights, press [RESET] button to turn off the FILTER lamp.

7-14. Auto Restart Function

This indoor unit is equipped with an automatic restarting function which allows the unit to restart operating with the set operating conditions in the event of a power supply being accidentally shut down.

The operation will resume without warning three minutes after power is restored.

This function is not set to work when shipped from the factory. Therefore it is necessary to set it to work.

7-14-1. How to Set the Auto Restart Function

To set the auto restart function, proceed as follows:

The power supply to the unit must be on ; the function will not set if the power is off.

Press the [RESET] button located in the center of the front panel continuously for three seconds.

The unit receives the signal and beeps three times.

The unit then restarts operating automatically in the event of power supply being accidentally shut down.

• When the unit is standby (Not operating)

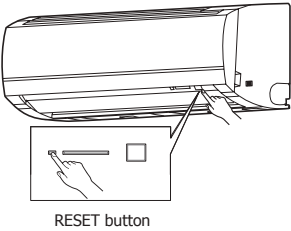
Operation	Motions
<p>Press [RESET] button for more than three seconds. (Less than 10 seconds)</p>  <p>RESET button</p>	<p>The unit is on standby.</p> <p style="text-align: center;">↓</p> <p>The unit starts to operate. The green indicator is on.</p> <p style="text-align: center;">↓ After approx. three seconds,</p> <p>The unit beeps three times and continues to operate. The green indicator blinks for 5 seconds.</p> <p>If the unit is not required to operate at this time, press [RESET] button once more or use the remote controller to turn it off.</p>

• When the unit is in operation

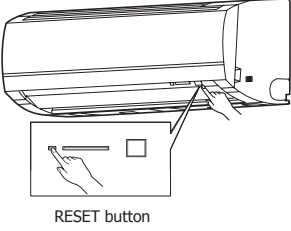
Operation	Motions
<p>Press [RESET] button for more than three seconds. (Less than 10 seconds)</p>  <p>RESET button</p>	<p>The unit is in operation. The green indicator is on.</p> <p style="text-align: center;">↓</p> <p>The unit stops operating. The green indicator is turned off.</p> <p style="text-align: center;">↓ After approx. three seconds,</p> <p>The unit beeps three times. The green indicator blinks for 5 seconds.</p> <p>If the unit is required to operate at this time, press [RESET] button once more or use the remote controller to turn it on.</p>

- While the filter check indicator is on, the RESET button has the function of filter reset button.

7-14-2. How to Cancel the Auto Restart Function

To cancel auto restart function, proceed as follows :

Repeat the setting procedure : the unit receives the signal and beeps three times.

The unit will be required to be turned on with the remote controller after the main power supply is turned off.

• **When the system is on stand-by (not operating)**

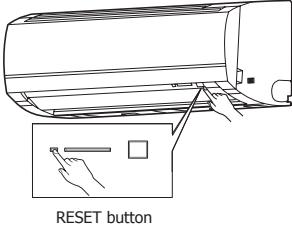
Operation	Motions
<p>Press [RESET] button for more than three seconds. (Less than 10 seconds)</p>  <p>RESET button</p>	<p>The unit is on standby.</p> <p style="text-align: center;">↓</p> <p>The unit starts to operate. The green indicator is on.</p> <p style="text-align: center;">↓ After approx. three seconds,</p> <p>The unit beeps three times and continues to operate.</p> <p>If the unit is not required to operate at this time, press [RESET] button once more or use the remote controller to turn it off.</p>

• **When the system is operating**

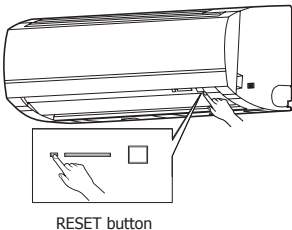
Operation	Motions
<p>Press [RESET] button for more than three seconds. (Less than 10 seconds)</p>  <p>RESET button</p>	<p>The unit is in operation. The green indicator is on.</p> <p style="text-align: center;">↓</p> <p>The unit stops operating. The green indicator is turned off.</p> <p style="text-align: center;">↓ After approx. three seconds,</p> <p>The unit beeps three times.</p> <p>If the unit is required to operate at this time, press [RESET] button once more or use the remote controller to turn it on.</p>

7-14-3. Power Failure During Timer Operation

When the unit is turned off because of power failure during timer operation, the timer operation is cancelled. In that case, set the timer operation again.

NOTE :

The Everyday Timer is reset while a command signal can be received from the remote controller even if it stopped due to a power failure.

7-15. Self-Cleaning function

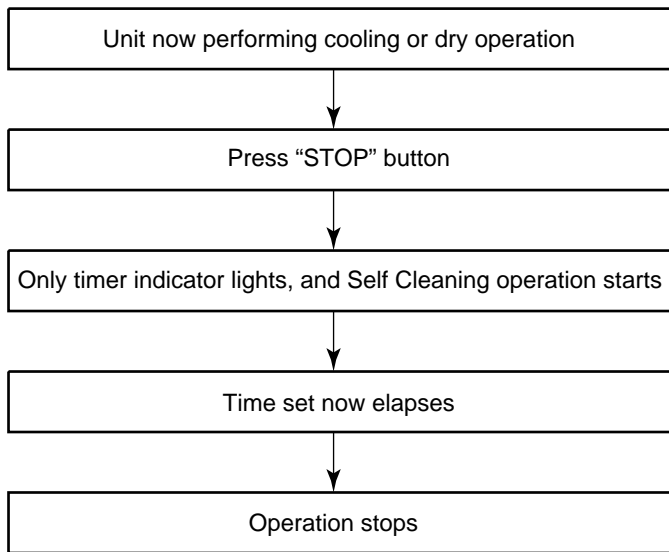

- During Self-Cleaning operations: The louver opens slightly. The indoor fan operates continuously at a speed of SL rpm.

Self-Cleaning operation times

	Operation time	Self-Cleaning operation time
Cooling: Auto (cooling) Dry	Up to 10 minutes	No Self-Cleaning operation performed (0 minutes)
	10 minutes or longer	20 mins.
Heating: Auto (heating)	No Self-Cleaning operation performed	
Auto (fan only)		
Shutdown		

- To stop an ongoing Self-Cleaning operation at any time Press the start/stop button on the remote controller twice during the Self-Cleaning operation. (After pressing the button for the first time, press it for the second time without delay (within 10 minutes).)

1. Purpose

The Self-Cleaning operation is to minimize the growth of mold, bacteria etc. by running the fan and drying so as to keep the inside of the air conditioner clean.

Self-Cleaning operation

When the cooling or dry operation shuts down, the unit automatically starts the Self- Cleaning operation which is then performed for the specified period based on duration of the operation which was performed prior to the shutdown, after which the Self-Cleaning operation stops. (The Self-Cleaning operation is not performed after a heating operation.)

2. Operation

- 1) When the stop signal from the remote controller or timer-off function is received, only the timer indicator light.
- 2) The period of the Self-Cleaning operation is determined by the duration of the operation performed prior to the reception of the stop code.
- 3) After the Self-Cleaning operation has been performed for the specified period, the unit stops operation.

7-15-1. Self-Cleaning diagram

Operation display	ON	OFF	OFF
FCU fan	ON rpm is depend on presetting.	ON (SL)	OFF
FCU louver	OPEN	OPEN (11.3°)	CLOSE
Timer display	ON or OFF depend on presetting of timer function.	ON	ON or OFF depend on presetting of timer function.
Compressor	ON or OFF depend on presetting per room temperature.	OFF	OFF
CDU fan	ON or OFF depend on presetting per room temperature.	OFF	OFF

Turn off by remote controller or timer-off function. Automatically turn-off.

7-15-2. Self-Cleaning function release

How to cancel Self-Cleaning function

To cancel the Self-Cleaning function, proceed as follows :

How to cancel Self-Cleaning function

To cancel the Self-Cleaning function, proceed as follows:

- Press [RESET] button one time or use remote control to turn on air conditioner. Display will show in green color.
- Hold down the [RESET] button for more than 20 seconds. (The air conditioner will stop suddenly when the [RESET] is pressed but keep holding it continue. The will beep 3 times in the first 3 seconds but it is not related to Self-Cleaning function)
- After holding about 20 seconds, the air conditioner will beep 5 times without any blinking of display.
- The Self-Cleaning Operation had been cancelled.

Remark

Presetting of Self-Cleaning function above, AUTO-RESTART function had been cancelled. To set AUTO-RESTART again.

How to set Self-Cleaning function

To set the Self-Cleaning function, proceed as follows.

- Press [RESET] button one time or use remote control to turn on air conditioner. Display will show in green color.
- Hold down the [RESET] button for more than 20 seconds. (The air conditioner will stop suddenly when the [RESET] is pressed but keep holding it continue. Then will beep 3 times is the first 3 seconds but it is not related to Self-Cleaning function)
- After holding about 20 seconds, the air conditioner will beep 5 times and OPERATION display blinks 5 times.
- The Self-Cleaning function had been set.

Remark

Presetting of Self-Cleaning function above, AUTO-RESTART function had been cancelled. To set AUTO-RESTART again.

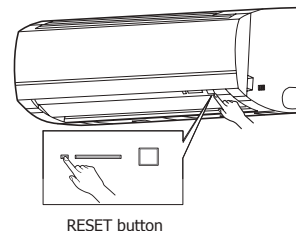

8. INSTALLATION PROCEDURE

8-1. Safety Cautions

For general public use

Power supply cord of parts of appliance for Outdoor use shall be at least polychloroprene sheathed flexible cord (design H07 RN-F), or cord designation 245 IEC66. (Shall be installed in accordance with national wiring regulations.)

CAUTION

To Disconnect the Appliance from the Main Power Supply

This appliance must be connected to the main power supply by means of a circuit breaker or a switch with a contact separation of at least 3 mm in all poles.

If this is not possible, a power supply plug with earth must be used. This plug must be easily accessible after installation. The plug must be disconnected from the power supply socket in order to disconnect the appliance completely from the mains.

DANGER

- FOR USE BY QUALIFIED PERSONS ONLY.
- TURN OFF MAIN POWER SUPPLY BEFORE ATTEMPTING ANY ELECTRICAL WORK. MAKE SURE ALL POWER SWITCHES ARE OFF. FAILURE TO DO SO MAY CAUSE ELECTRIC SHOCK.
- CONNECT THE CONNECTING CABLE CORRECTLY. IF THE CONNECTING CABLE IS CONNECTED WRONGLY, ELECTRIC PARTS MAY BE DAMAGED.
- CHECK THE EARTH WIRE THAT IT IS NOT BROKEN OR DISCONNECTED BEFORE INSTALLATION.
- DO NOT INSTALL NEAR CONCENTRATIONS OF COMBUSTIBLE GAS OR GAS VAPORS. FAILURE TO FOLLOW THIS INSTRUCTION CAN RESULT IN FIRE OR EXPLOSION.
- TO PREVENT OVERHEATING THE INDOOR UNIT AND CAUSING A FIRE HAZARD, PLACE THE UNIT WELL AWAY (MORE THAN 2 M) FROM HEAT SOURCES SUCH AS RADIATORS, HEATERS, FURNACE, STOVES, ETC.
- WHEN MOVING THE AIR-CONDITIONER FOR INSTALLING IT IN ANOTHER PLACE AGAIN, BE VERY CAREFUL NOT TO GET THE SPECIFIED REFRIGERANT (R410A) WITH ANY OTHER GASEOUS BODY INTO THE REFRIGERATION CYCLE. IF AIR OR ANY OTHER GAS IS MIXED IN THE REFRIGERANT, THE GAS PRESSURE IN THE REFRIGERATION CYCLE BECOMES ABNORMALLY HIGH AND IT RESULTINGLY CAUSES BURST OF THE PIPE AND INJURIES ON PERSONS.
- IN THE EVENT THAT THE REFRIGERANT GAS LEAKS OUT OF THE PIPE DURING THE INSTALLATION WORK, IMMEDIATELY LET FRESH AIR INTO THE ROOM. IF THE REFRIGERANT GAS IS HEATED BY FIRE OR SOMETHING ELSE, IT CAUSES GENERATION OF POISONOUS GAS.

WARNING

- Never modify this unit by removing any of the safety guards or bypassing any of the safety interlock switches.
- Do not install in a place which cannot bear the weight of the unit. Personal injury and property damage can result if the unit falls.
- Before doing the electrical work, attach an approved plug to the power supply cord. Also, make sure the equipment is properly earthed.
- Appliance shall be installed in accordance with national wiring regulations. If you detect any damage, do not install the unit. Contact your TOSHIBA dealer immediately.

CAUTION

- Exposure of unit to water or other moisture before installation could result in electric shock. Do not store it in a wet basement or expose to rain or water.
- After unpacking the unit, examine it carefully for possible damage.
- Do not install in a place that can increase the vibration of the unit. Do not install in a place that can amplify the noise level of the unit or where noise and discharged air might disturb neighbors.
- To avoid personal injury, be careful when handling parts with sharp edges.
- Please read this installation manual carefully before installing the unit. It contains further important instructions for proper installation.

REQUIREMENT OF REPORT TO THE LOCAL POWER SUPPLIER

Please make absolutely sure that the installation of this appliance is reported to the local power supplier before installation. If you experience any problems, or if the installation is not accepted by the supplier, the service agency will take adequate countermeasures.

Remark per EMC Directive 89/336/EEC

To prevent flicker impressions during the start of the compressor (technical process) following installation conditions do apply.

1. The power connection for the air conditioner has to be done at the main power distribution. This distribution has to be of an impedance.
Normally the required impedance is reached at a 32A fusing point. Air conditioner fuse has to be 16A max.!
2. No other equipment should be connected to this power line.
3. For detailed installation acceptance, please contact your power supplier whether its restriction does apply for products like washing machines, air conditioners or electrical ovens.
4. For power details of the air conditioner, refer to the rating plate of the product.

8-2. Installation Diagram of Indoor and Outdoor Units

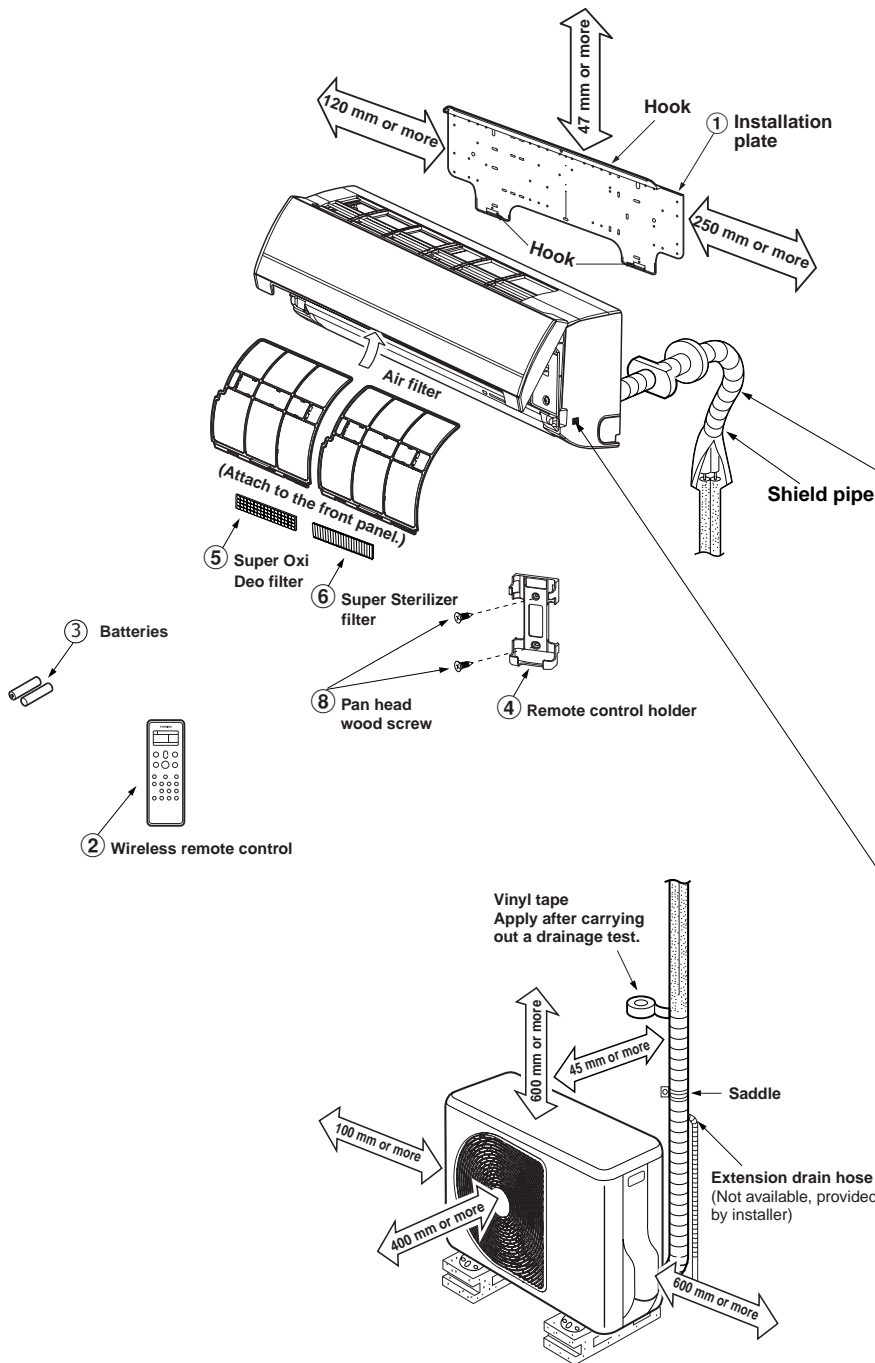

For the rear left and left piping

Insert the cushion between the indoor unit and wall, and tilt the indoor unit for better operation.

Do not allow the drain hose to get slack.

Cut the piping hole sloped slightly.

Make sure to run the drain hose sloped downward.

The auxiliary piping can be connected to the left, rear left, rear right, right, bottom right or bottom left.

Right, Rear right, Bottom right, Rear left, Left, Bottom left

Insulate the refrigerant pipes separately with insulation, not together.

6 mm thick heat resisting polyethylene foam

Before installing the wireless remote controller

- **Loading Batteries**
 1. Remove the battery cover.
 2. Insert 2 new batteries (AAA type) following the (+) and (-) positions.

③ Batteries

② Wireless remote controller

8-3. Installation

8-3-1. Optional installation parts

Part Code	Parts name	Q'ty
A	Refrigerant piping Liquid side : $\varnothing 6.35$ mm Gas side : $\varnothing 9.52$ mm	One each
B	Pipe insulating material (polyethylene foam, 6 mm thick)	1
C	Putty, PVC tapes	One each

<Fixing bolt arrangement of outdoor unit>

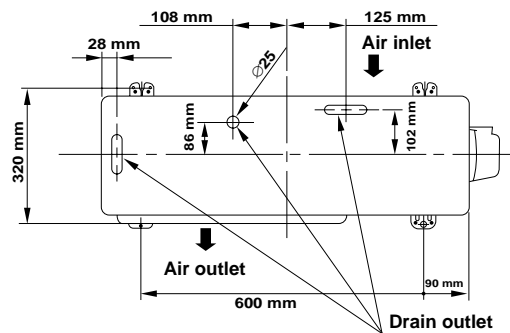
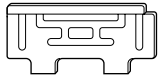
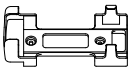

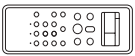

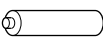

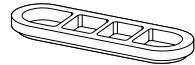

Fig. 8-3-1

- Secure the outdoor unit with fixing bolts and nuts if the unit is likely to be exposed to a strong wind.
- Use $\varnothing 8$ mm or $\varnothing 10$ mm anchor bolts and nuts.
- If it is necessary to drain the defrost water, attach drain nipple (9) and cap water proof (10) to the bottom plate of the outdoor unit before installing it.

8-3-2. Accessory and installation parts

Part No.	Part name (Q'ty)	Part No.	Part name (Q'ty)	Part No.	Part name (Q'ty)			
①	 Installation plate x 1	④	 Remote control holder x 1	⑦	 Mounting screw $\varnothing 4 \times 25 \text{ l} \times 6$			
②	 Wireless remote control x 1	⑤	 Super Oxi Deo filter x 1	⑧	 Flat head wood screw $\varnothing 3.1 \times 16 \text{ l} \times 2$			
③	 Battery x 2	⑥	 Super Sterilizer filter x 1	⑨	 Drain nipple* x 1			
Others	<table border="1"> <thead> <tr> <th>Name</th> </tr> </thead> <tbody> <tr> <td>Owner's manual</td> </tr> <tr> <td>Installation manual</td> </tr> </tbody> </table>	Name	Owner's manual	Installation manual			⑩	 Cap water proof* x 2 (For Heat pump model only)
Name								
Owner's manual								
Installation manual								







The part marked with asterisk (*) is packaged with the outdoor unit.

8-3-3. Installation/Serviceing Tools**<Changes in the product and components>**

In the case of an air conditioner using R410A, in order to prevent any other refrigerant from being charged accidentally, the service port diameter of the outdoor unit control valve (3 way valve) has been changed.
(1/2 UNF 20 threads per inch)

- In order to increase the pressure resisting strength of the refrigerant piping, flare processing diameter and size of opposite side of flare nuts has been changed. (for copper pipes with nominal dimensions 1/2 and 5/8)

New tools for R410A

New tools for R410A	Applicable to R22 model		Changes
Gauge manifold	×		As pressure is high, it is impossible to measure by means of conventional gauge. In order to prevent any other refrigerant from being charged, each port diameter has been changed.
Charge hose	×		In order to increase pressure resisting strength, hose materials and port size have been changed (to 1/2 UNF 20 threads per inch). When purchasing a charge hose, be sure to confirm the port size.
Electronic balance for refrigerant charging	○		As pressure is high and gasification speed is fast, it is difficult to read the indicated value by means of charging cylinder, as air bubbles occur.
Torque wrench (nominal diam. 1/2, 5/8)	×		The size of opposite sides of flare nuts have been increased. Incidentally, a common wrench is used for nominal diameters 1/4 and 3/8.
Flare tool (clutch type)	○		By increasing the clamp bar's receiving hole, strength of spring in the tool has been improved.
Gauge for projection adjustment	—		Used when flare is made by using conventional flare tool.
Vacuum pump adapter	○		Connected to conventional vacuum pump. It is necessary to use an adapter to prevent vacuum pump oil from flowing back to the charge hose. The charge hose connecting part has two ports-one for conventional refrigerant (7/16 UNF 20 threads per inch) and one for R410A. If the vacuum pump oil (mineral) mixes with R410A a sludge may occur and damage the equipment.
Gas leakage detector	×		Exclusive for HFC refrigerant.

- Incidentally, the “refrigerant cylinder” comes with the refrigerant designation (R410A) and protector coating in the U. S's ARI specified rose color (ARI color code: PMS 507).
- Also, the “charge port and packing for refrigerant cylinder” require 1/2 UNF 20 threads per inch corresponding to the charge hose's port size.

8-4. Indoor Unit

8-4-1. Installation place

- A place which provides the spaces around the indoor unit as shown in the above diagram.
- A place where there is no obstacle near the air inlet and outlet.
- A place that allows easy installation of the piping to the outdoor unit.
- A place which allows the front panel to be opened.

CAUTION

- Direct sunlight to the indoor unit's wireless receiver should be avoided.
- The microprocessor in the indoor unit should not be too close to RF noise sources.
(For details, see the owner's manual.)

<Remote control>

- A place where there are no obstacles such as a curtain that may block the signal from the indoor unit.
- Do not install the remote control in a place exposed to direct sunlight or close to a heating source, such as a stove.
- Keep the remote control at least 1 m apart from the nearest TV set or stereo equipment. (This is necessary to prevent image disturbances or noise interference.)
- The location of the remote control should be determined as shown below.

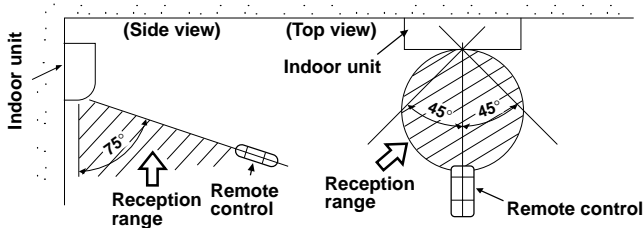

Fig. 8-4-1

8-4-2. Cutting a hole and mounting installation plate

<Cutting a hole>

When installing the refrigerant pipes from the rear.

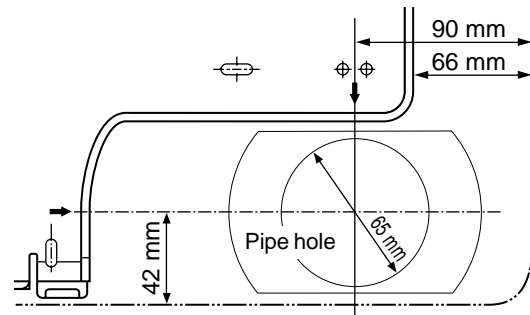

Fig. 8-4-2

1. After determining the pipe hole position on the mounting plate (➔), drill the pipe hole (∅65 mm) at a slight downward slant to the outdoor side.

NOTE

- When drilling a wall that contains a metal lath, wire lath or metal plate, be sure to use a pipe hole brim ring sold separately.

<Mounting the installation plate>

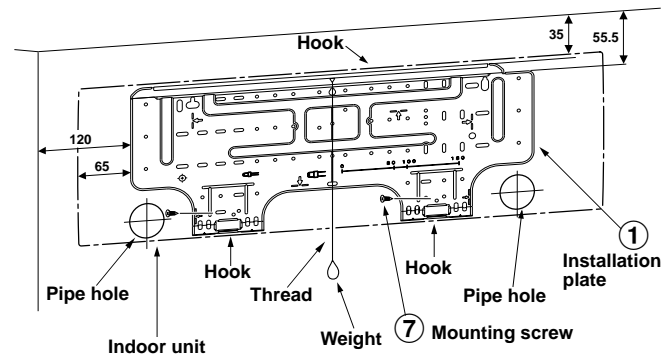

Fig. 8-4-3

<When the installation plate is directly mounted on the wall>

1. Securely fit the installation plate onto the wall by screwing it in the upper and lower parts to hook up the indoor unit.
2. To mount the installation plate on a concrete wall with anchor bolts, utilize the anchor bolt holes as illustrated in the above figure.
3. Install the installation plate horizontally in the wall.

CAUTION

When installing the installation plate with a mounting screw, do not use the anchor bolt hole. Otherwise the unit may fall down and result in personal injury and property damage.

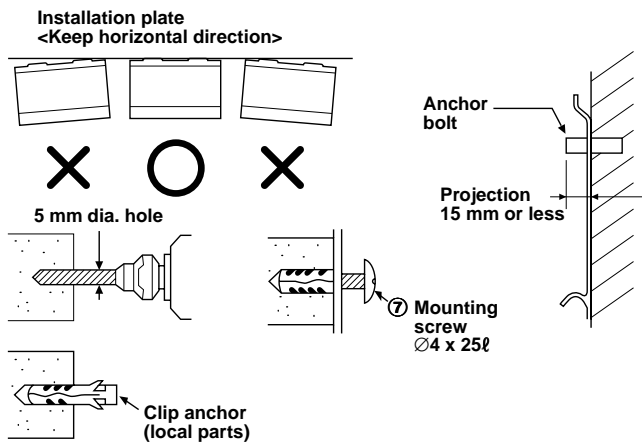

Fig. 8-4-4

CAUTION

Failure to firmly install the unit may result in personal injury and property damage if the unit falls.

- In case of block, brick, concrete or similar type walls, make 5 mm dia. holes in the wall.
- Insert clip anchors for appropriate ⑦ mounting screws.

NOTE

- Secure four corners and lower parts of the installation plate with 4 to 6 mounting screws to install it.

8-4-3. Electrical work

1. The supply voltage must be the same as the rated voltage of the air conditioner.
2. Prepare the power source for exclusive use with the air conditioner.

CAUTION

- This appliance can be connected to the mains in either of the following two ways.
 - (1) Connection to fixed wiring:
A switch or circuit breaker which disconnects all poles and has a contact separation of at least 3 mm must be incorporate in the fixed wiring. An approved circuit breaker or switches must used.
 - (2) Connection with power supply plug:
Attach power supply plug with power cord and plug it into wall outlet. An approved power supply cord and plug must be used.

NOTE

- Ensure all wiring is used within its electrical rating.

Model	10 Class
Power source	50Hz, 220 - 240 V Single phase
Maximum running current	7.5A
Plug socket & fuse rating	16A
Power cord	1 mm ² or more

<How to connect the connecting cable>

Wiring of the connecting cable can be carried out without removing the front panel.

1. Remove the air inlet grille.
Open the air inlet grille upward and pull it toward you.
2. Remove the terminal cover and cord clamp.
3. Insert the connecting cable (according to the local cords) into the pipe hole on the wall.
4. Take out the connecting cable through the cable slot on the rear panel so that it protrudes about 15 cm from the front.
5. Insert the connecting cable fully into the terminal block and secure it tightly with screws.
6. Tightening torque : 1.2 N·m (0.12 kgf·m)
7. Secure the connecting cable with the cord clamp.
8. Fix the terminal cover, rear plate bushing and air inlet grille on the indoor unit.

CAUTION

- Be sure to refer to the wiring system diagram labeled inside the front panel.
- Check local electrical cords and also any specific wiring instructions or limitations.

RAS-10SKP-ES

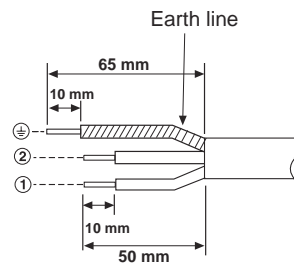
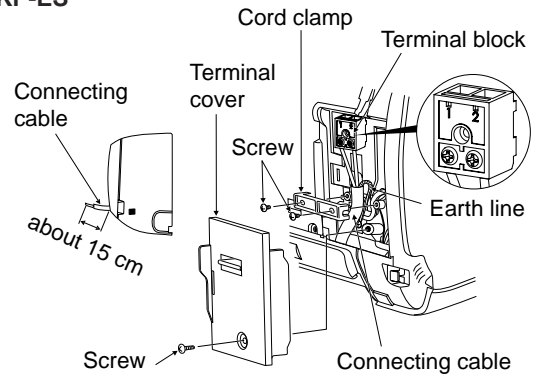

Stripping length of the connecting cable

Fig. 8-4-6

RAS-10SKHP-ES

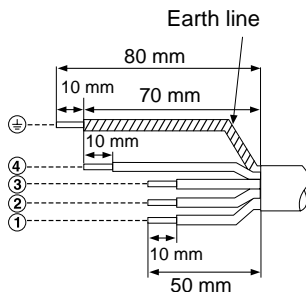
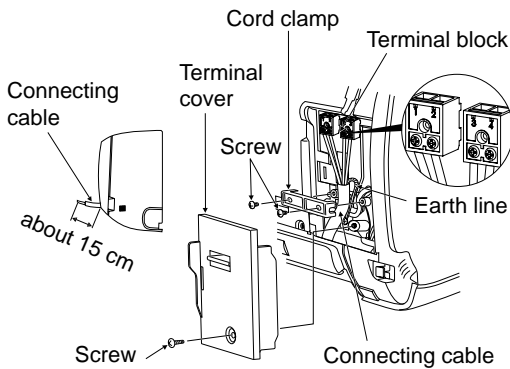

Stripping length of the connecting cable

Fig. 8-4-5

NOTE

- Use stranded wire only.
- Wire type : H07 RN-F or more

<How to install the air inlet grille on the indoor unit>

- When attaching the air inlet grille, the contrary of the removed operation is performed.

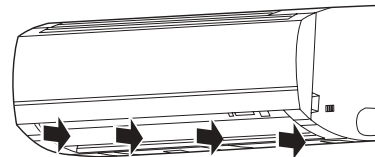
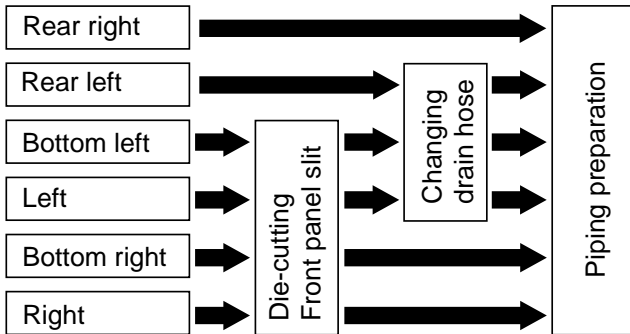

Fig. 8-4-7

8-4-4. Piping and drain hose installation

<Piping and drain hose forming>

* Since dewing results in a machine trouble, make sure to insulate both the connecting pipes. (Use polyethylene foam as insulating material.)



1. Die-cutting Front panel slit

For leftward connection, cut out slit on the left side of the front panel. (A knife will produce splinters, so use nippers.)

2. Changing drain hose

For leftward connection, bottom leftward connection and rear leftward connection's piping, it is necessary to change the drain hose and drain cap.

How to remove the drains cap

Clip drain cap by needle-nose plier, and pull out.

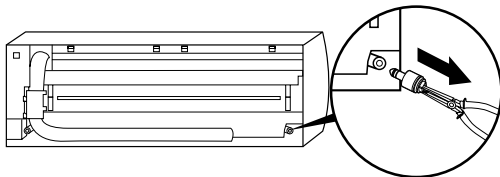

Fig. 8-4-8

How to install the drain hose

Firmly insert drain hose connecting part until hitting on a heat insulator.

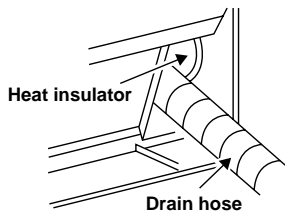

Fig. 8-4-9

How to fix the drains cap

1) Insert hexagonal wrench (4 mm) in a center head.

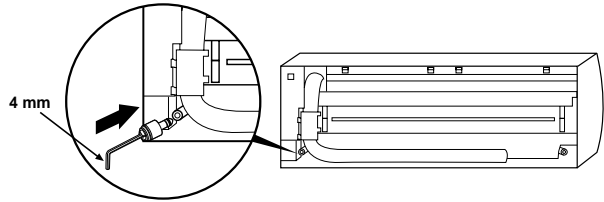

Fig. 8-4-10

2) Firmly insert drains cap.

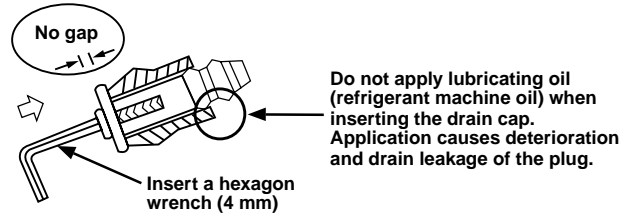

Fig. 8-4-11

CAUTION

Firmly insert the drain hose and drain cap; otherwise, water may leak.

<In case of right or left piping>

- After scribing slits of the front panel with a knife or a making-off pin, cut them with a pair of nippers or an equivalent tool.

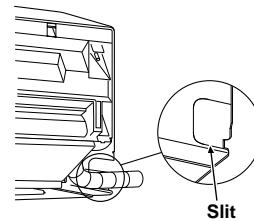

Fig. 8-4-12

<In case of bottom right or bottom left piping>

- After scribing slits of the front panel with a knife or a making-off pin, cut them with a pair of nippers or an equivalent tool.

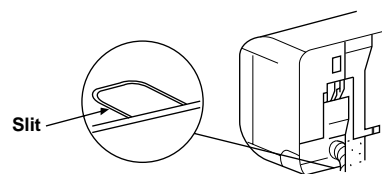

Fig. 8-4-13

<Left-hand connection with piping>

Bend the connecting pipe so that it is laid within 43 mm above the wall surface. If the connecting pipe is laid exceeding 43 mm above the wall surface, the indoor unit may unstably be set on the wall. When bending the connecting pipe, make sure to use a spring bender so as not to crush the pipe.

Bend the connection pipe within a radius of 30 mm.

To connect the pipe after installation of the unit (figure)

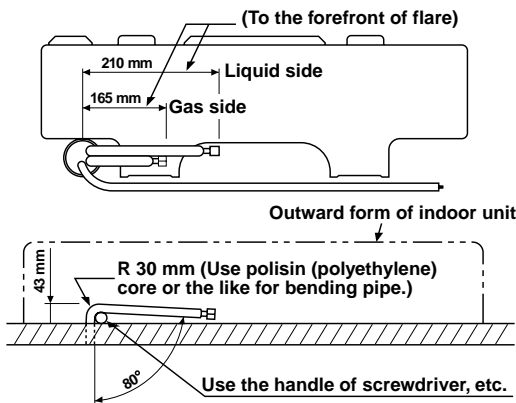

Fig. 8-4-14

NOTE

If the pipe is bent incorrectly, the indoor unit may unstably be set on the wall. After passing the connecting pipe through the pipe hole, connect the connecting pipe to the auxiliary pipes and wrap the facing tape around them.

CAUTION

- Bind the auxiliary pipes (two) and connecting cable with facing tape tightly. In case of leftward piping and rear-leftward piping, bind the auxiliary pipes (two) only with facing tape.

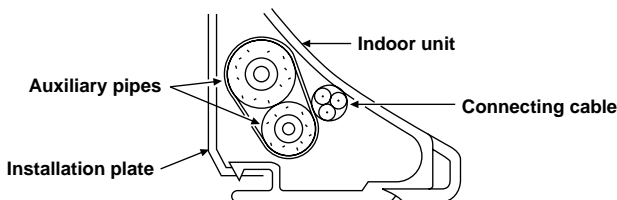

- Carefully arrange pipes so that any pipe does not stick out of the rear plate of the indoor unit.
- Carefully connect the auxiliary pipes and connecting pipes to each other and cut off the insulating tape wound on the connecting pipe to avoid double-taping at the joint, moreover, seal the joint with the vinyl tape, etc.
- Since dewing results in a machine trouble, make sure to insulate both the connecting pipes. (Use polyethylene foam as insulating material.)
- When bending a pipe, carefully do it, not to crush it.

8-4-5. Indoor unit fixing

1. Pass the pipe through the hole in the wall, and hook the indoor unit on the installation plate at the upper hooks.
2. Swing the indoor unit to right and left to confirm that it is firmly hooked up on the installation plate.
3. While pressing the indoor unit onto the wall, hook it at the lower part on the installation plate. Pull the indoor unit toward you to confirm that it is firmly hooked up on the installation plate.

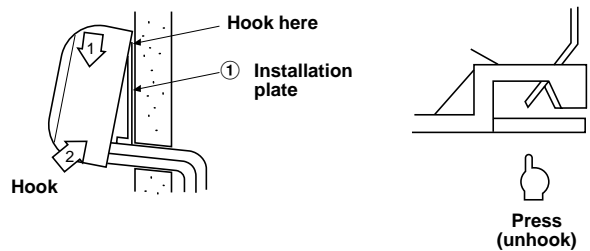

Fig. 8-4-15

- For detaching the indoor unit from the installation plate, pull the indoor unit toward you while pushing its bottom up at the specified parts.

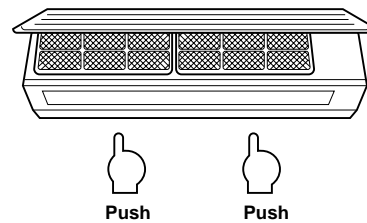
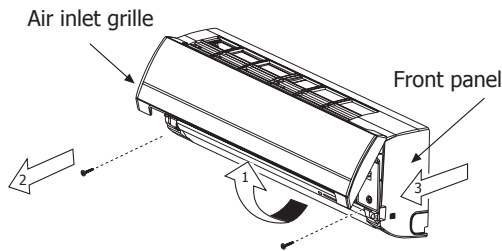

Fig. 8-4-16

8-4-6. Wiring Connection



<How to connect the power cord>

For the air conditioner that does not have power cord, connect a power cord to it as mentioned below.

- (1) Open the air inlet grille upward.
- (2) Remove the two screws securing the front panel.
- (3) Before slightly open the lower part of the front panel, pushing at specified bottom up until front take off from installation plate. And then pull the upper part of the front panel toward you to remove it from the rear plate.
- (4) After removing the front panel, remove the power cord connect cover and the cord clamp.
- (5) Connect and secure the power supply cord and secure the cord clamp and the power cord connect cover.
- (6) Put the power supply cord through the notch.
- (7) Be sure to smooth the notch with a file, etc.

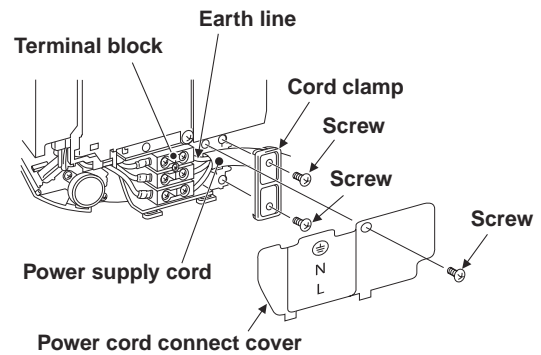

Fig. 8-4-17

Stripping length of the power supply cord

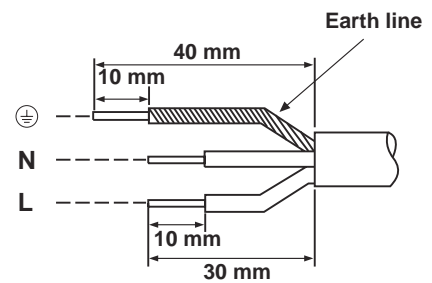

Fig. 8-4-18

NOTE

Use stranded wire only.
Wire type : H07RN-F or more

CAUTION

For the air conditioner with the power supply cord

- If the power supply cord is damaged, it must be replaced by the manufacturer, the service agency, or another similarly qualified person in order to avoid hazard.

Taking out the power cord

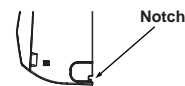

- Put the power supply cord through the notch.

8-4-7. Drainage

1. Run the drain hose sloped downwards.

NOTE

- Hole should be made at a slight downward slant on the outdoor side.

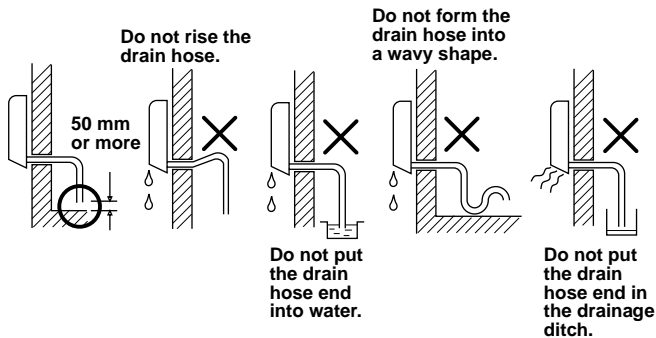

Fig. 8-4-19

2. Put water in the drain pan and make sure that the water is drained out of doors.
3. When connecting extension drain hose, insulate the connecting part of extension drain hose with shield pipe.

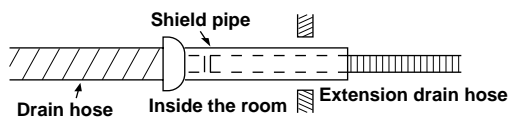

Fig. 8-4-20

CAUTION

Arrange the drain pipe for proper drainage from the unit.
Improper drainage can result in dew-dropping.

This air conditioner has the structure designed to drain water collected from dew, which forms on the back of the indoor unit, to the drain pan. Therefore, do not store the power cord and other parts at a height above the drain guide.

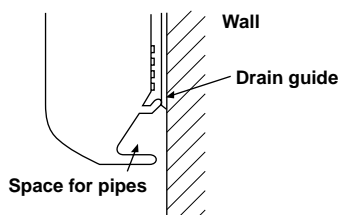

Fig. 8-4-21

8-5. Outdoor Unit

8-5-1. Installation place

- A place which provides the spaces around the outdoor unit as shown in the left diagram.
- A place which can bear the weight of the outdoor unit and does not allow an increase in noise level and vibration.
- A place where the operation noise and discharged air do not disturb your neighbors.
- A place which is not exposed to a strong wind.
- A place free of a leakage of combustible gases.
- A place which does not block a passage.
- When the outdoor unit is to be installed in an elevated position, be sure to secure its feet.
- An allowable length of the connecting pipe is up to 10 m.
- An allowable height level is up to 5 m.
- A place where the drain water does not raise any problem.

CAUTION

1. Install the outdoor unit without anything blocking the air discharging.
2. When the outdoor unit is installed in a place exposed always exposed to strong wind like a coast or on a high storey of a building, secure the normal fan operation using a duct or a wind shield.
3. In particularly windy areas, install the unit such as to avoid admission of wind.
4. Installation in the following places may result in trouble.

Do not install the unit in such places.

- A place full of machine oil.
- A saline-place such as the coast.
- A place full of sulfide gas.
- A place where high-frequency waves are likely to be generated as from audio equipment, welders, and medical equipment.

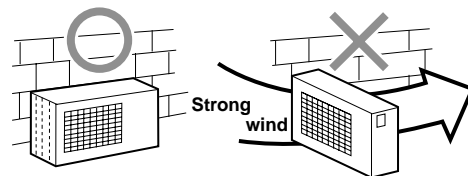

Fig. 8-5-1

(Unit : N·m)

8-5-2. Refrigerant piping connection

1. Cut the pipe with a pipe cutter.

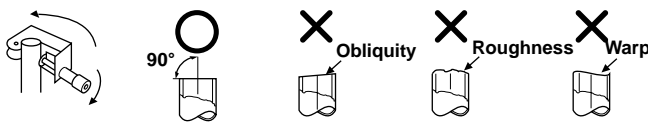

Fig. 8-5-2

2. Insert a flare nut into the pipe, and flare the pipe.

- **Projection margin in flaring : A (Unit : mm)**

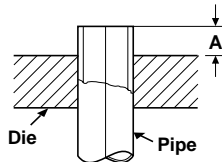

Fig. 8-5-3

Rigid (Clutch type)

Outer dia. of copper pipe	R410A tool used	Conventional tool used
6.35	0 to 0.5	1.0 to 1.5
9.52	0 to 0.5	1.0 to 1.5

Imperial (wing nut type, conventional tool)

Outer dia. of copper pipe	R410A
6.35	1.5 to 2.0
9.52	1.5 to 2.0

<Tightening connection>

Align the centers of the connecting pipes and tighten the flare nut as far as possible with your fingers. Then tighten the nut with a spanner and torque wrench as shown in the figure.

CAUTION

- Do not apply excess torque.
- Otherwise, the nut may crack depending on the conditions.

Outer dia. of copper pipe	Tightening torque
Ø6.35	16 to 18 (1.6 to 1.8 kgf·m)
Ø9.52	30 to 42 (3.0 to 4.2 kgf·m)

• Tightening torque of flare pipe connections

The operating pressure of R410A is higher than that of R22. (Approx. 1.6 times). It is therefore necessary to firmly tighten the flare pipe connecting sections (which connect the indoor and outdoor units) up to the specified tightening torque. Incorrect connections may cause not only a gas leakage, but also damage to the refrigerant cycle.

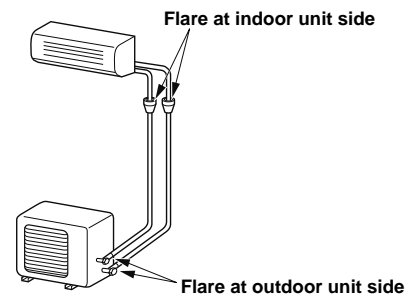

Fig. 8-5-4

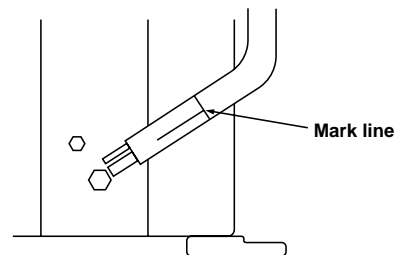
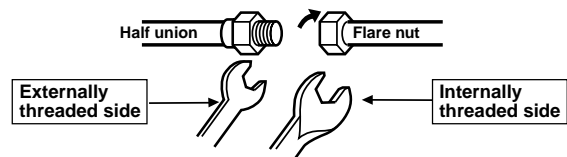

Fig. 8-5-5



Use a wrench to secure. Use a torque wrench to tighten.

Fig. 8-5-6

CAUTION

- **KEEP IMPORTANT 5 POINTS FOR PIPING WORK**
 - (1) Take away dust and moisture (Inside of the connecting pipes.)
 - (2) Tight connection (between pipes and unit)
 - (3) Evacuate the air in the connecting pipes using VACUUM PUMP.
 - (4) Check gas leak (connected points)
 - (5) Be save to fully open the packed valves before operation.

8-5-3. Evacuating

After the piping has been connected to the indoor unit, you can perform the air purge together at once.

AIR PURGE

Evacuate the air in the connecting pipes and in the indoor unit using a vacuum pump. Do not use the refrigerant in the outdoor unit.
For details, see the manual of the vacuum pump.

<Using a vacuum pump>

Be sure to use a vacuum pump with counter-flow prevention function so that inside oil of the pump does not flow backward into pipes of the air conditioner when the pump stops.

1. Connect the charge hose from the manifold valve to the service port of the gas side packed valve.
2. Connect the charge hose to the port of the vacuum pump.
3. Open fully the low pressure side handle of the gauge manifold valve.
4. Operate the vacuum pump to start evacuating. Perform evacuating for about 15 minutes if the piping length is 20 meters. (15 minutes for 20 meters) (assuming a pump capacity of 27 liters per minute.) Then confirm that the compound pressure gauge reading is -101 kPa (76 cmHg).
5. Close the low pressure side valve handle of gauge manifold.
6. Open fully the valve stem of the packed valves (both sides of Gas and Liquid).
7. Remove the charging hose from the service port.
8. Securely tighten the caps on the packed valves.

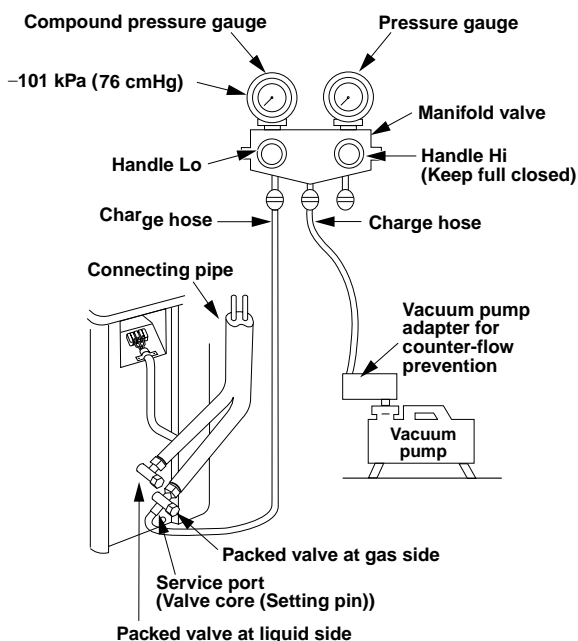

Fig. 8-5-7

<Packed valve handling precautions>

- Open the valve stem all the way out; but do not try to open it beyond the stopper.
- Securely tighten the valve stem cap with torque in the following table:

Gas side ($\varnothing 9.52 \text{ mm}$)	30 to 42 N·m (3.0 to 4.2 kgf·m)
Liquid side ($\varnothing 6.35 \text{ mm}$)	16 to 18 N·m (1.6 to 1.8 kgf·m)
Service port	9 to 10 N·m (0.9 to 1.0 kgf·m)

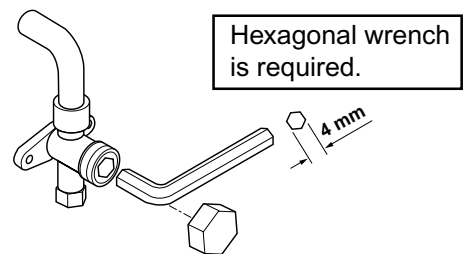

Fig. 8-5-8

8-5-4. Wiring connection

1. Remove the valve cover from the outdoor unit.
2. Connect the connecting cable to the terminal as identified with their respective matched numbers on the terminal block of indoor and outdoor unit.
3. When connecting the connecting cable to the outdoor unit terminal, make a loop as shown in the installation diagram of indoor and outdoor unit, to prevent water coming in the outdoor unit.
4. Insulate the unused cords (conductors) from any water coming in the outdoor unit. Proceed them so that they do not touch any electrical or metal parts.

<Stripping length of connecting cable>

For RAS-10S2AH-ES

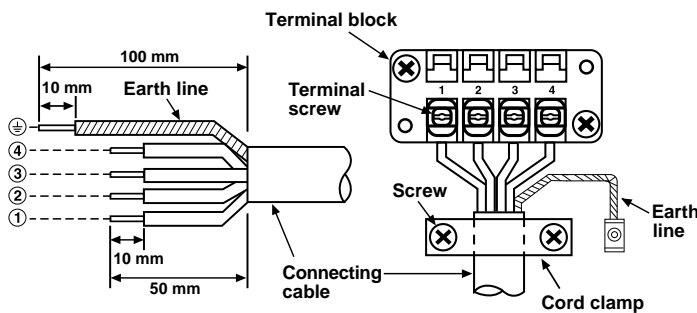

Fig. 8-5-9

For RAS-10SA-ES

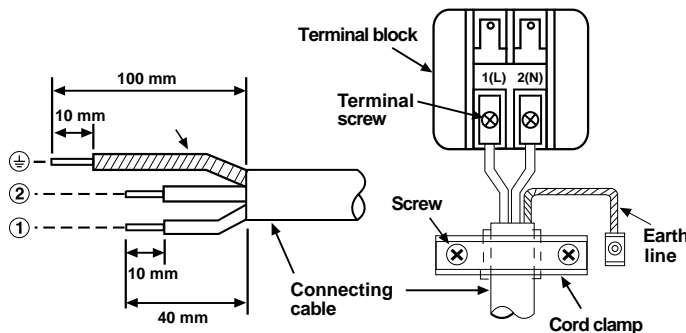

Fig. 8-5-10

CAUTION

- Wrong wiring connection may cause some electrical parts burn out.
- Be sure to comply with local codes on running the wire from indoor unit to outdoor unit (size of wire and wiring method etc.)
- Every wire must be connected firmly.

NOTE

- Wire type: H07 RN-F or 245 IEC66 (2.0 mm² or more)

8-6. How to Set Remote Control Selector Switch

When two indoor units are installed in separated rooms, there is no need to change the selector switch.

<Remote control selector switch>

- When two indoor units are installed in the same room or the adjacent two rooms, they may be controlled simultaneously with a single remote control. To prevent this, set either unit and its remote control to B setting. (Both units are set to A setting before shipment.)
- The remote control signal is not received when the indoor unit setting is different from the remote control one.

<Remote control A-B Selection>

To separate using of remote control for each indoor unit in case of 2 air conditioner are installed nearby.

Remote Control B Setup.

1. Press RESET button on the indoor unit to turn the air conditioner ON.
2. Point the remote control at the indoor unit.
3. Push and hold CHK• button on the Remote Control by the tip of the pencil. "00" will be shown on the display the air conditioner ON.
4. Press MOD• during pushing CHK•. "B" will show on the display and "00" will disappear and the air conditioner will turn OFF. The Remote Control B is memorized.

- Note:**
1. Repeat above step to reset Remote Control to be A.
 2. Remote Control A has not "A" display.
 3. Default setting of Remote Control from factory is A.

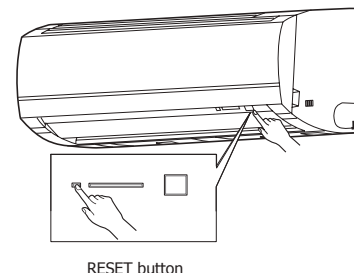

RESET button

Fig. 8-6-1

2. Set the remote control selector switch with the remote control

1. Setting of remote control selector at the remote control side

Remote Control B Setup

- Press RESET button on the indoor unit to turn the air conditioner NO.
- Point the remote control at the indoor unit.
- Push and hold CHK button on the Remote Control by the tip of the pencil. "00" will be shown on the display.
- Press **MODE** during pushing CHK. "B" will be shown on the display and "00" will disappear and the air conditioner will turn OFF. The Remote Control B is memorized.

NOTE

- Repeat above step to reset Remote Control to be A.
- Remote Control A have not "A" display.
- Default setting of Remote Control from factory is A.

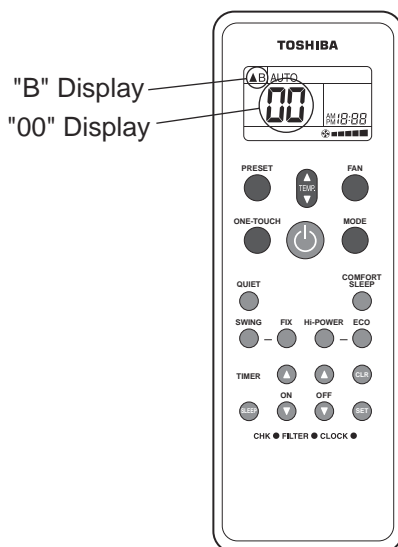

Fig. 8-6-2

8-7. Others

8-7-1. Gas leak test

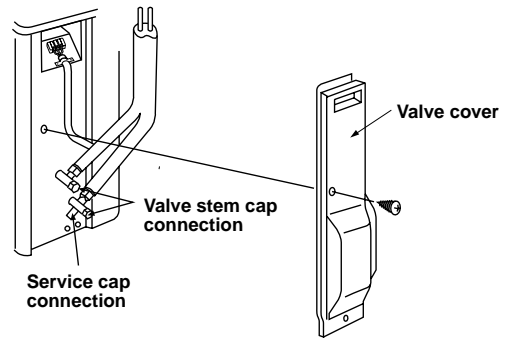

Fig. 8-7-1

- Check the flare nut connections, valve stem cap connections and service port cap connections for gas leak with a leak detector or soap water.

8-7-2. Test operation

To switch the TEST RUN (COOL) mode, press RESET button for 10 sec.
(The beeper will make a short beep.)

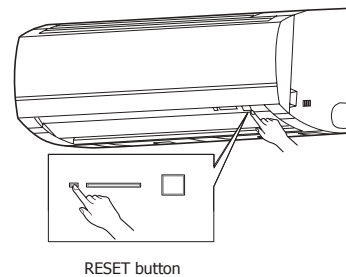

Fig. 8-7-2

8-7-3. Auto restart setting

This product is designed so that, after a power failure, it can restart automatically in the same operating mode as before the power failure.

Information

The product was shipped with Auto Restart function in the off position. Turn it on as required.

<How to set the auto restart>

- Press and hold the RESET button for about 3 seconds. After 3 seconds, the electronic beeper makes three short beeps to tell you the Auto Restart has been selected.
- To cancel the Auto Restart, follow the steps described in the section Auto Restart Function of the Owner's Manual.

9. TROUBLESHOOTING CHART

9-1. Troubleshooting Procedure

Follow the details of 9-2. Basic Check Items. If there is no trouble corresponding to 9-2, check whether or not there are faulty parts following 9-4. Self-Diagnosis by Remote Control.

9-2. Basic Check Items

9-2-1. Power supply voltage

The line voltage must be AC 220 – 240V. If it is not within this range, the air conditioner may not operate normally.

9-2-2. Incorrect cable connection between Indoor and outdoor units

The indoor unit is connected to the outdoor unit with 5 cables (Heat pump model) or 3 cables (Cooling Only model). Check that the indoor and outdoor units have been properly connected with terminals assigned the same numbers. If the connectors are not properly connected, the outdoor unit will not operate normally, or OPERATION lamp and TIMER lamp will blink (5Hz).

9-2-3. Program control

The microcontroller operates as shown in Table 9-2-1 to control the air conditioner. If there are any operational problems, check whether or not the problems correspond to Table 9-2-1. If they correspond to the Table, they are not problems with the air conditioner, but they are indispensable operations to control and maintain the air conditioner properly.

Table 9-2-1

No.	Operation of air conditioner	Descriptions
1	When the main power supply is turned on, the OPERATION lamp on the indoor unit blinks.	The OPERATION lamp blinks to indicate that power is turned on. If the [⏻] button is pressed, the lamp stops blinking.
2	The indoor fan motor speed does not change in the Dry operation.	The indoor fan motor speed is automatically controlled in the Dry operation.
3	The compressor is not turned off even though the room temperature is in the range that the compressor is turned off.	The compressor has a function that it is not turned off for 3 minutes after it is turned on even though the room temperature is in the range that the compressor is turned off.
4	The compressor is not turned on and off even though the thermo control is operated in the Dry operation.	In the Dry operation, the compressor is turned on and off automatically at the regular intervals, independent of the thermo control.
5	The outdoor fan motor stops in the Heating operation.	When the indoor heat exchanger temperature is high, the outdoor fan motor is stopped by the high-temperature limit control operation.
6	The compressor is not turned on even though the room temperature is in the range that the compressor is turned on.	The compressor is not turned on in the restart delay timer (3-minutes timer) operation. It is also not turned on after the power supply is turned on because of this timer operation.
7	The operation mode changes in the Automatic operation.	In Automatic operation, the room temperature is detected all time for control fan speed and the operation mode is changed every 15 minutes according to difference between the room temperature and the preset temperature.
8	The Fan only operation continues in the Automatic operation.	When the room temperature is in the range (Preset temperature $\pm 1^{\circ}\text{C}$), the Fan only operation is selected.
9	The Hi-POWER operation does not work.	This operation does not work when the unit is in the Dry operation or Fan only operation.

9-3. Primary Judgement

9-3-1. Role of indoor unit controller

The indoor unit controller receives the operation commands from the remote control and executes them.

- Temperature measurement at the air outlet of the indoor heat exchanger by the indoor temperature sensor
- Temperature setting of the indoor heat exchanger by the heat exchanger sensor
- Louver motor control
- Indoor fan motor operation control
- LED display control
- Transferring of operation commands to the outdoor unit

9-3-2. Failure diagnosis

The indoor unit diagnoses the operation condition and indicates the information of the self-diagnosis with the lamps on the display panel of the indoor unit.

Table 9-3-1

	Lamps	Self-diagnosis
A	OPERATION lamp is blinking. (1Hz)	Power failure (when the power supply is turning on)
B	OPERATION lamp is blinking. (5Hz)	Thermo sensor (TA) short or break
C	OPERATION lamp is blinking. (5Hz)	Heat exchanger sensor (TC) short or break
D	OPERATION lamp is blinking. (5Hz)	Indoor fan motor lock or failure
E	OPERATION lamp is blinking. (5Hz)	Indoor P.C. board failure
F	OPERATION and TIMER lamps are blinking. (5Hz)	Wrong wiring of connecting cable
G	OPERATION and TIMER lamps are blinking.	Cycle failure <ul style="list-style-type: none"> • <input type="checkbox"/> Gas shortage or other refrigerant cycle trouble • <input type="checkbox"/> Heat exchanger sensor open, break or short • <input type="checkbox"/> Overload relay or thermostat trouble of compressor

Table 9-3-2 Diagnosis by detective operation

Symptom	Check	Primary judgement	
The remote control does not work.	Turn off the power supply once, then turn it on. Try to operate the remote control.	The remote control still does not work.	The indoor unit (and/or remote control) is/are defective.
		The remote control works.	OK.
The outdoor fan does not rotate.	The compressor operates.	The outdoor unit (Outdoor fan motor) is defective.	
	The compressor does not operate.	An internal part of the compressor or PCB is defective.	

9-4. Self-Diagnosis by Remote Controller (Check Code)

1. If the lamps are indicated as shown B to E in Table 9-3-1, execute the self-diagnosis by the remote controller.
2. When the remote controller is set to the service mode, the indoor controller diagnoses the operation condition and indicates the information of the self-diagnosis on the display of the remote controller with the check codes. If a fault is detected, all lamps on the indoor unit will flash at 5Hz and it will beep for 10 seconds (Beep, Beep, Beep ...). The timer lamp usually flashes (5Hz) during self-diagnosis.

9-4-1. How to Use Remote Controller in Service Mode

1 Press [CHECK] button with a tip of pencil to set the remote controller to the service mode.

- “00” is indicated on the display of the remote controller.

2 Press [ON▲] or [OFF▲] button

If there is no fault with a code, the indoor unit will beep once (Beep) and the display of the remote controller will change as follows :

00 → 01 → 02 ... 1d → 1E → 33

- The TIMER indicator of the indoor unit flashes continuously. (5 times per 1 sec.)
- Check the unit with all 52 check codes (00 to 33) as shown in Table-11-4-1.
- Press [ON▼] or [OFF▼] button to change the check code backward.

If there is a fault, the indoor unit will beep for 10 seconds (Beep, Beep, Beep...).

Note the check code on the display of the remote controller.

- 2-digits alphanumeric will be indicated on the display.
- All indicators on the indoor unit will flash. (5 times per 1 sec.)

3 Press [CLR] button. After service finish for clear service code in memory.

- "7F" is indicated on the display of the remote control.

4 Press [⏻] button to release the service mode.

- The display of the remote controller returns to as it was before service mode was engaged.

Alphanumeric characters are used for the check codes.

5 is 5.	6 is 6.
A is A.	B is B.
C is C.	d is D.

Fig. 9-4-1

Table 9-4-1

Block level		Diagnosis function				Judgement and action
Check code	Block	Check code	Symptom	Air Conditioner status	Condition	
00	Indoor P.C. board	01	Thermo. sensor short/break.	Continued operation.	Indicated when detected abnormal	1. Check thermo sensor. 2. If it is OK, check P.C. board.
		02	Heat exchanger sensor short/break.	Continued operation.	Indicated when detected abnormal	1. Check heat exchanger sensor. 2. If it is OK, check P.C. board.
		11	Indoor fan lock, abnormality of indoor fan or thermal fuse break.	All off	Indicated when detected abnormal	1. Check heat thermal fuse is blow or not? (Terminal block part.) 2. If the thermal fuse is not blow, check indoor fan motor. (Refer to trouble shooting flow charts.)
		12	Abnormality of other indoor unit P.C. board.	All off	Indicated when detected abnormal	Replace P.C. board.
01	Cable connection/ Thermal fuse Refrigerant system	04	1) Wrong wiring or disconnection of connective cable. 2) Terminal fuse cut off.	All off	Indicated when detected abnormal	1. Check connective cable correct if wiring is wrong. 2. Check thermal fuse and Terminal blocks. 3. If it is OK, check P.C. board.
03	Other parts (including compressor)	09	1) Overload relay or thermostat for compressor break.	All off	Indicated when detected abnormal	1. If overload relay and thermostat for compressor are OK, check refrigerant cycle. 2. If refrigerant cycle is OK, check P.C. board. 3. If heat exchanger sensor is OK, check overload relay and thermostat for compressor.
Content detected by the check codes "04" to "12" are stored in memory of the microcomputer even if the power supply is turned off. Therefore, contents of operations in the past are all displayed.						

9-5. Troubleshooting Flowcharts

9-5-1. Power can not be turned on (No operation at all)

<Preliminary checks>

- (1) Is the supply voltage normal?
- (2) Is the connection to the AC outlet OK.?

Cooling Model

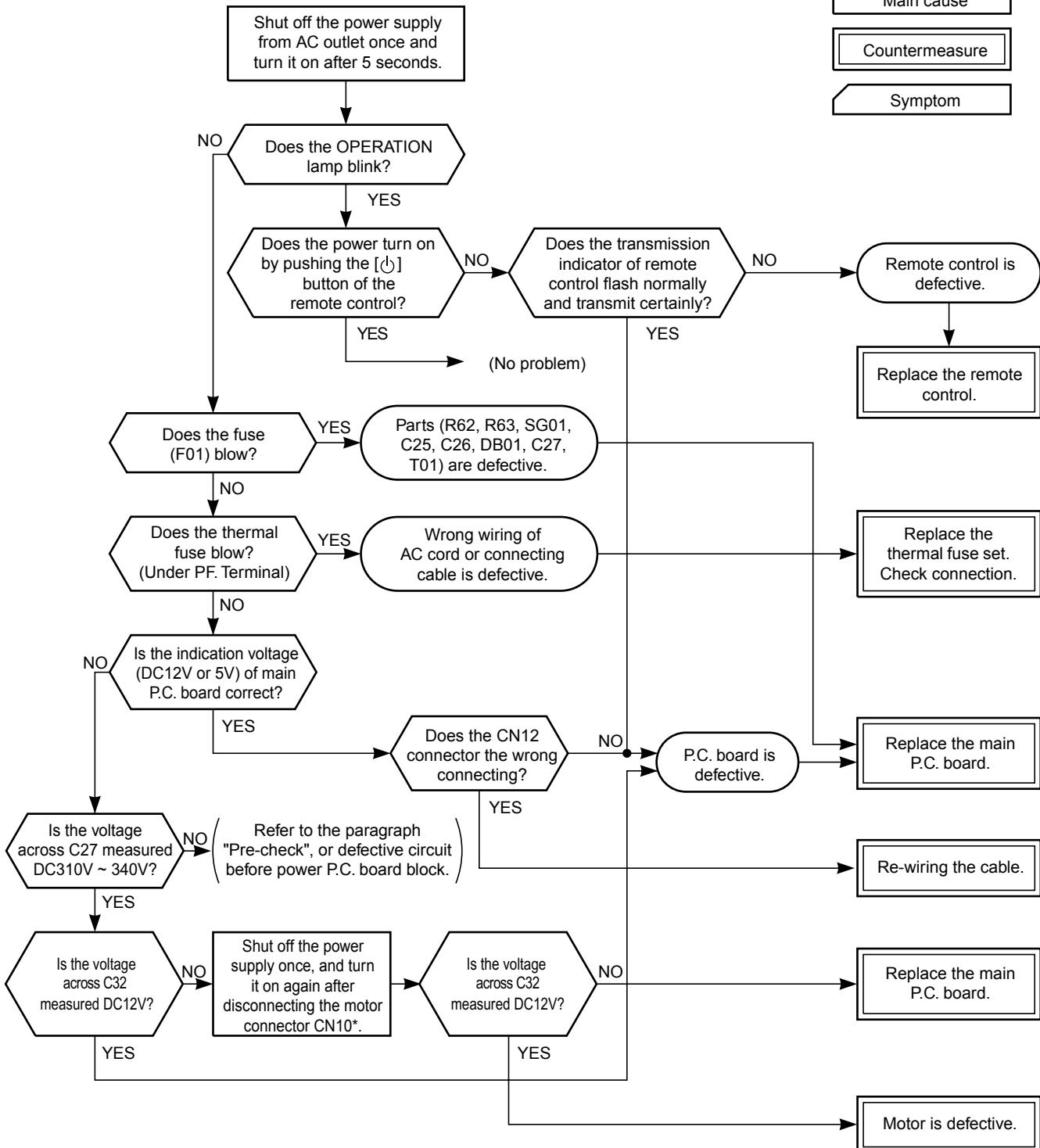
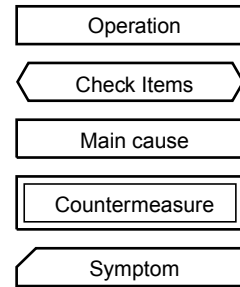

* Be sure to disconnect the motor connector CN10 after shut off the power supply, or it will be a cause of damage of the motor.

Heat pump Model

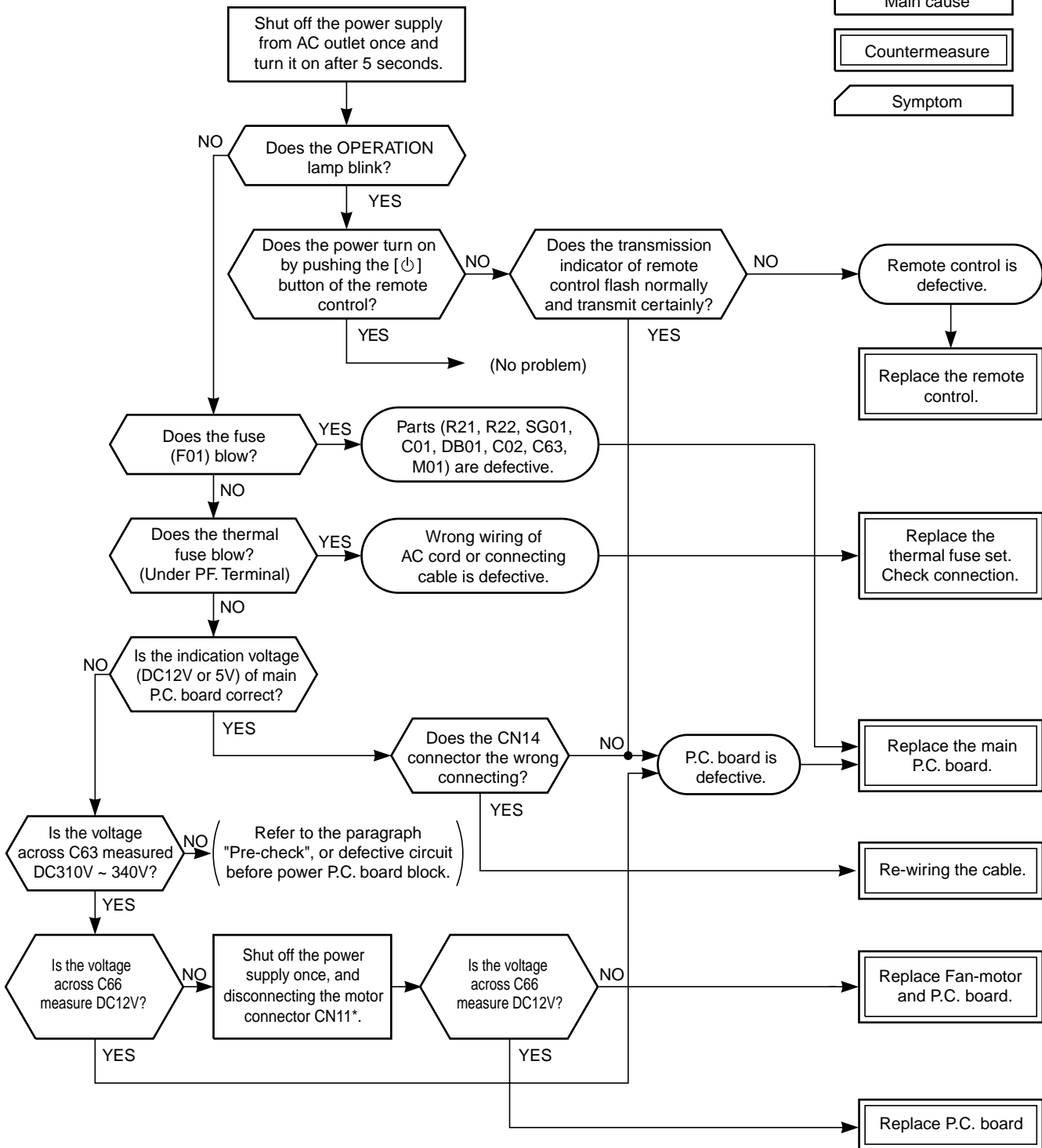
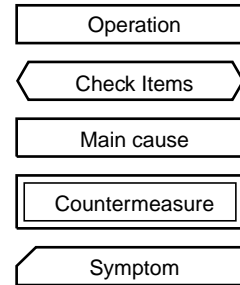

* Be sure to disconnect the motor connector CN10 after shut off the power supply, or it will be a cause of damage of the motor.

9-5-2. Power can not be turned on after replacing indoor P.C. board

<Checking Procedure>

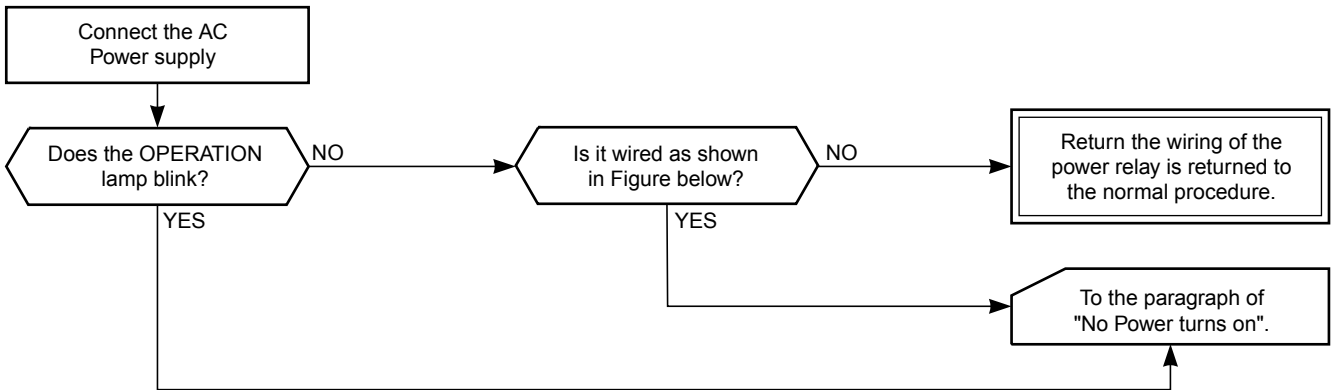

RAS-10SKP-ES

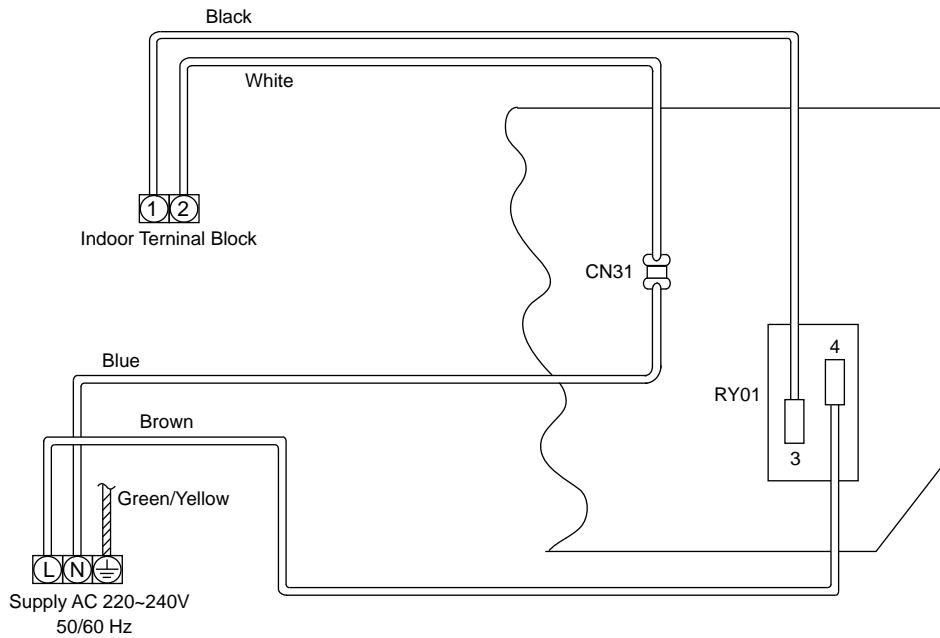

RAS-10SKHP-ES

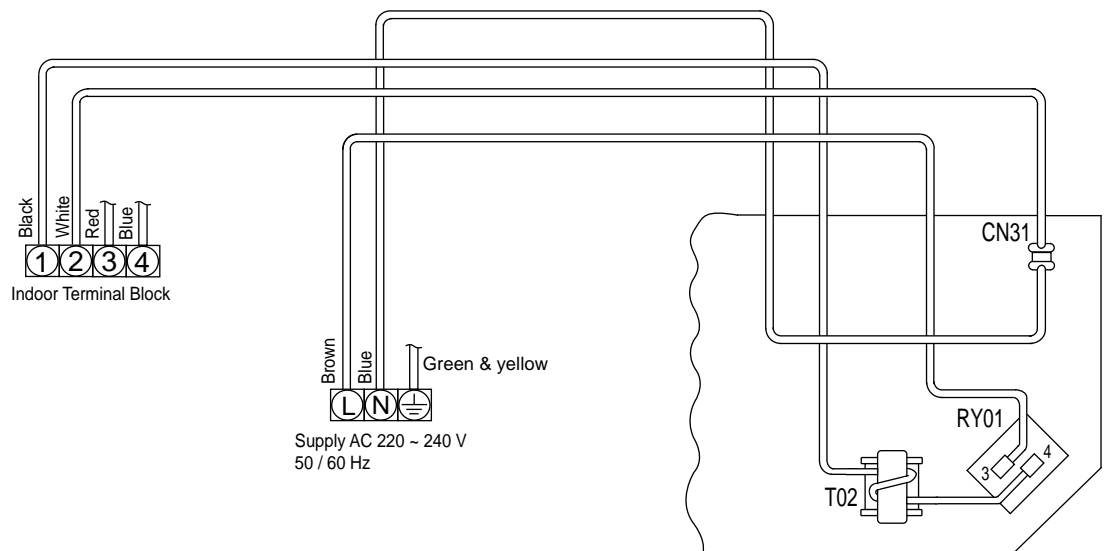

9-5-3. Outdoor unit does not operate

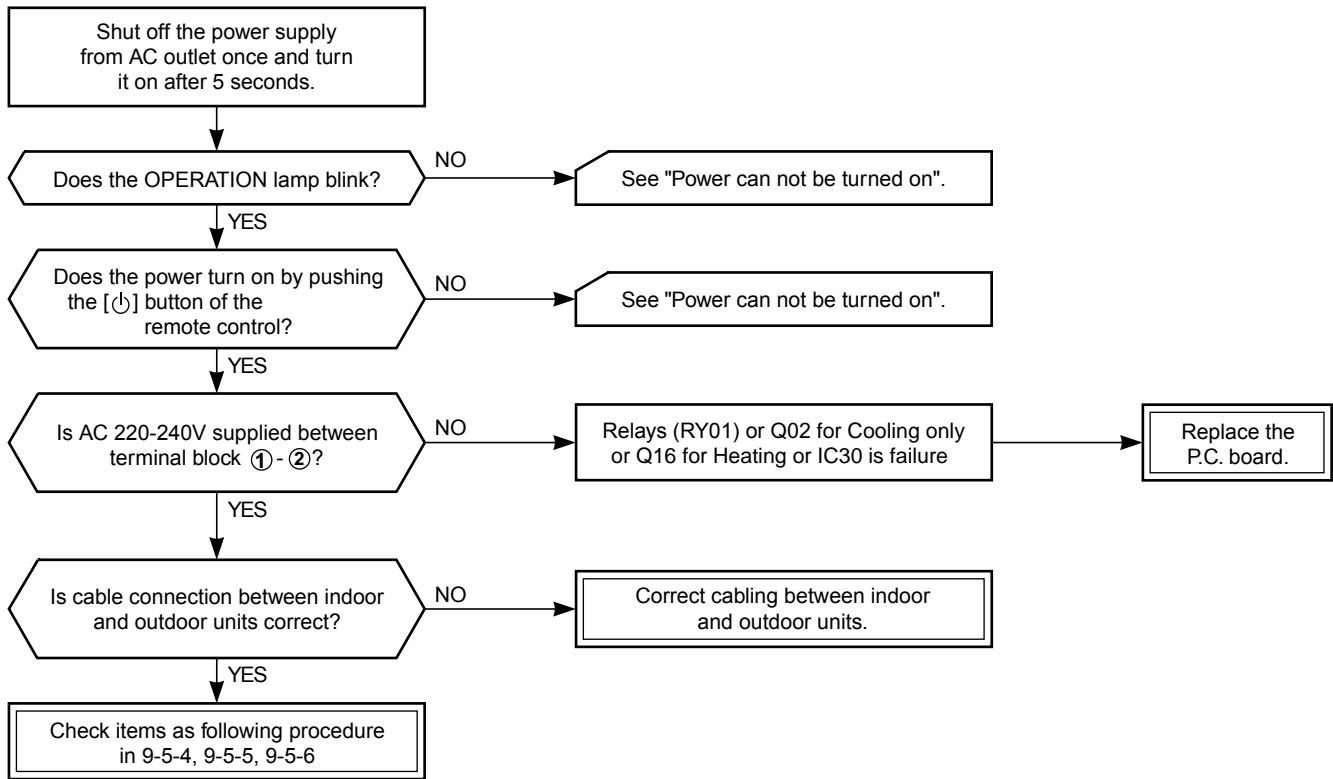

9-5-4. Only compressor does not operate

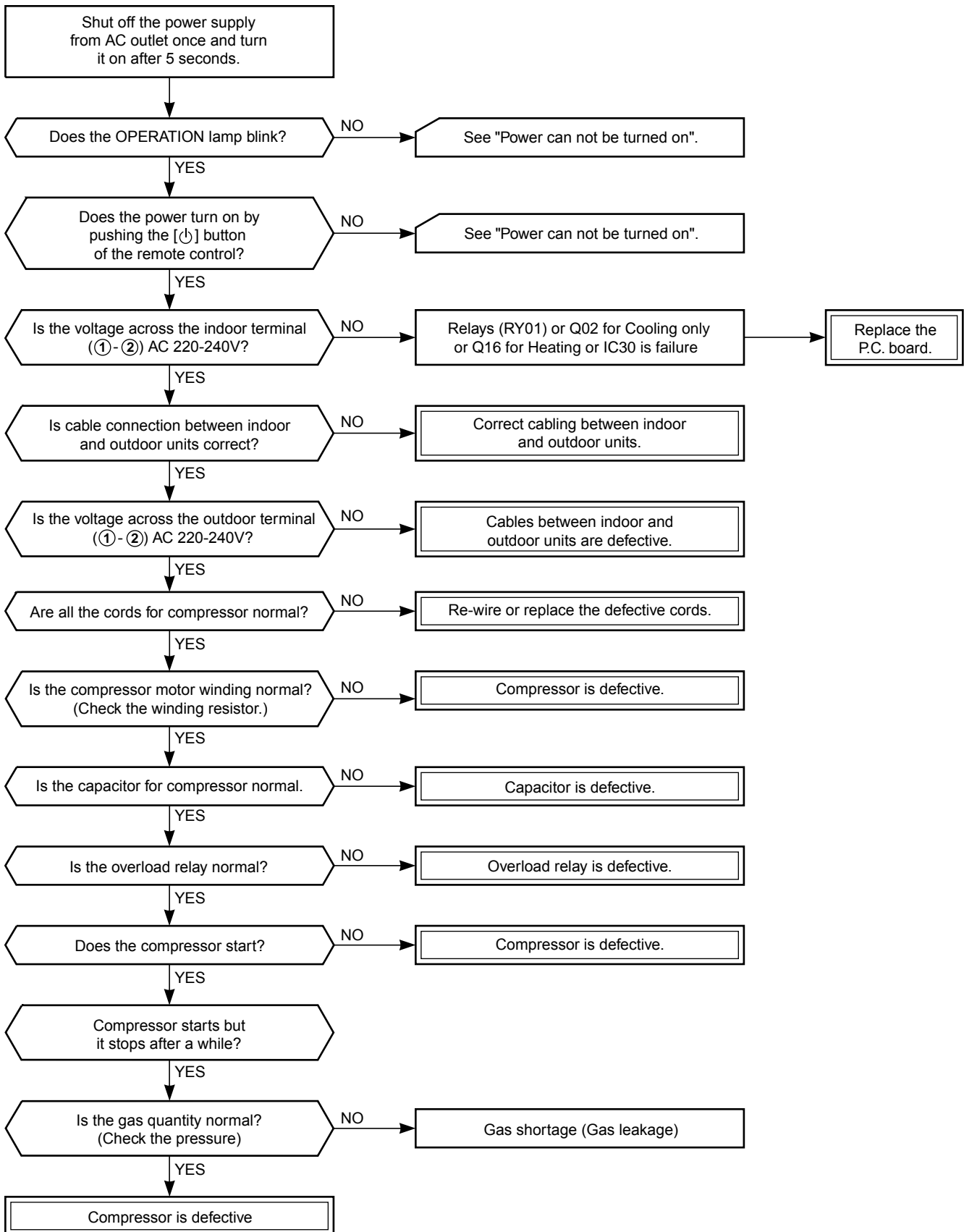

9-5-5. Only outdoor fan does not operate

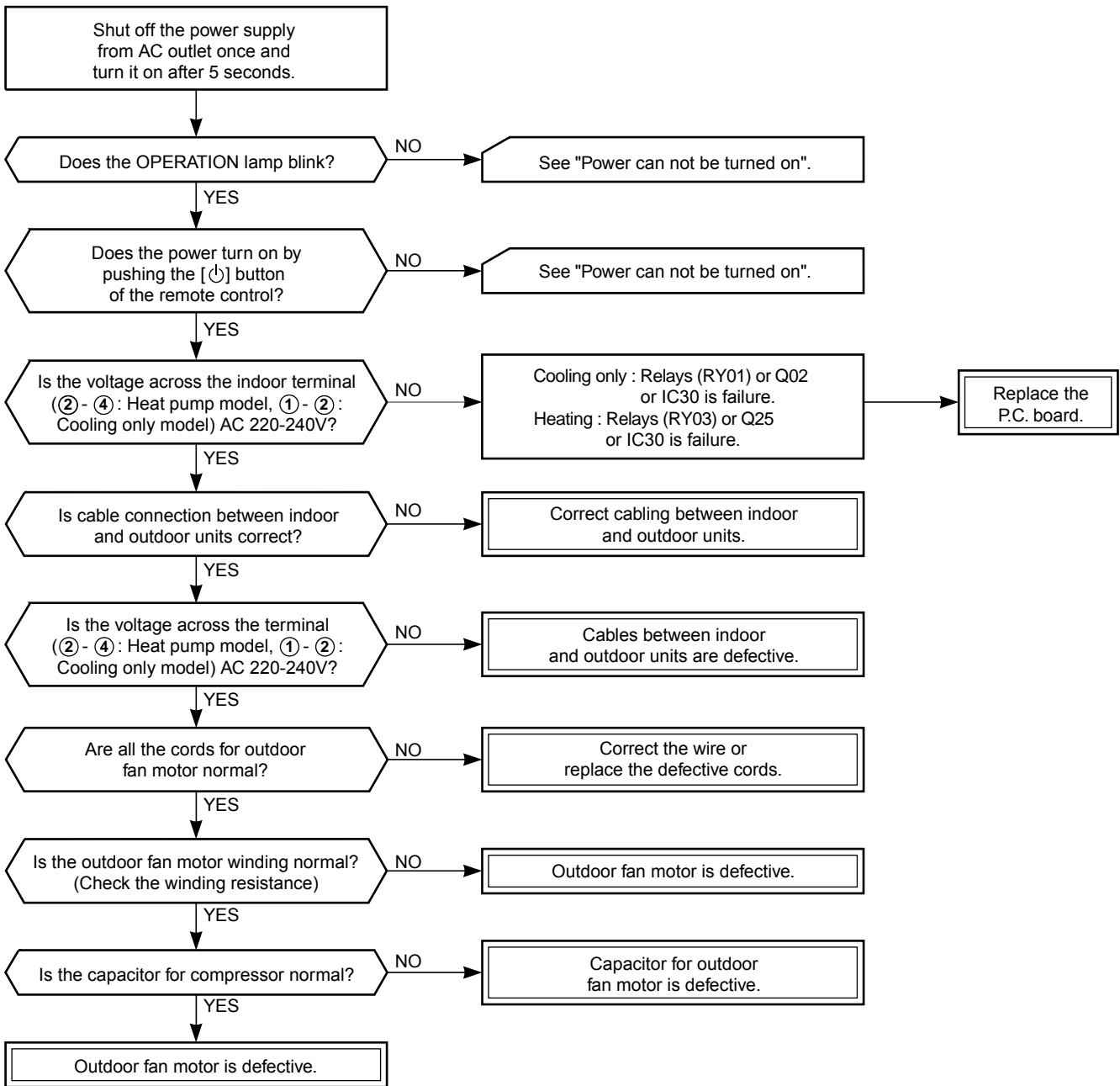

9-5-7. Only the indoor fan does not operate

<Check procedure>

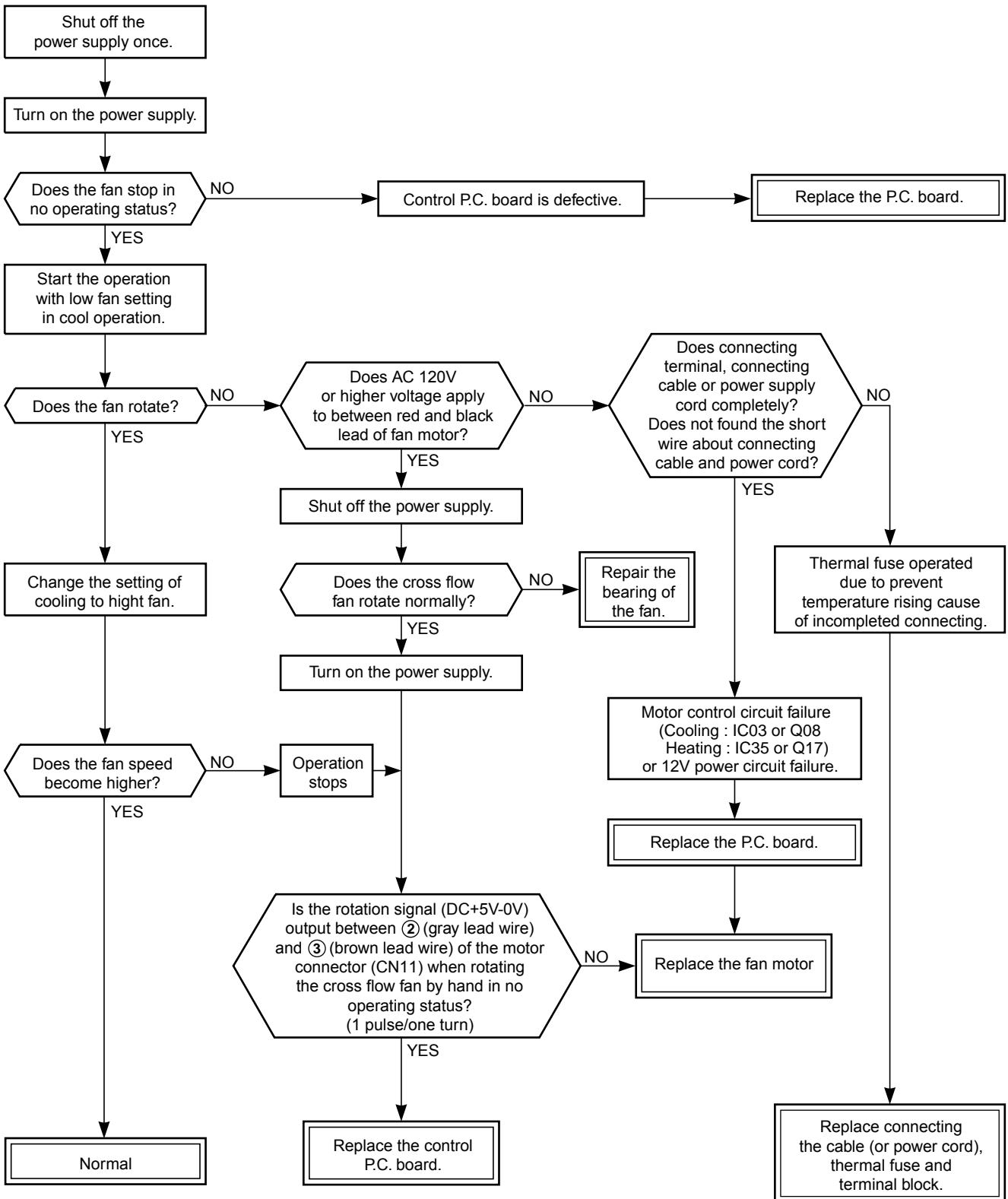

9-6. Troubleshooting for Remote Control (Including the Indoor P.C. Board)

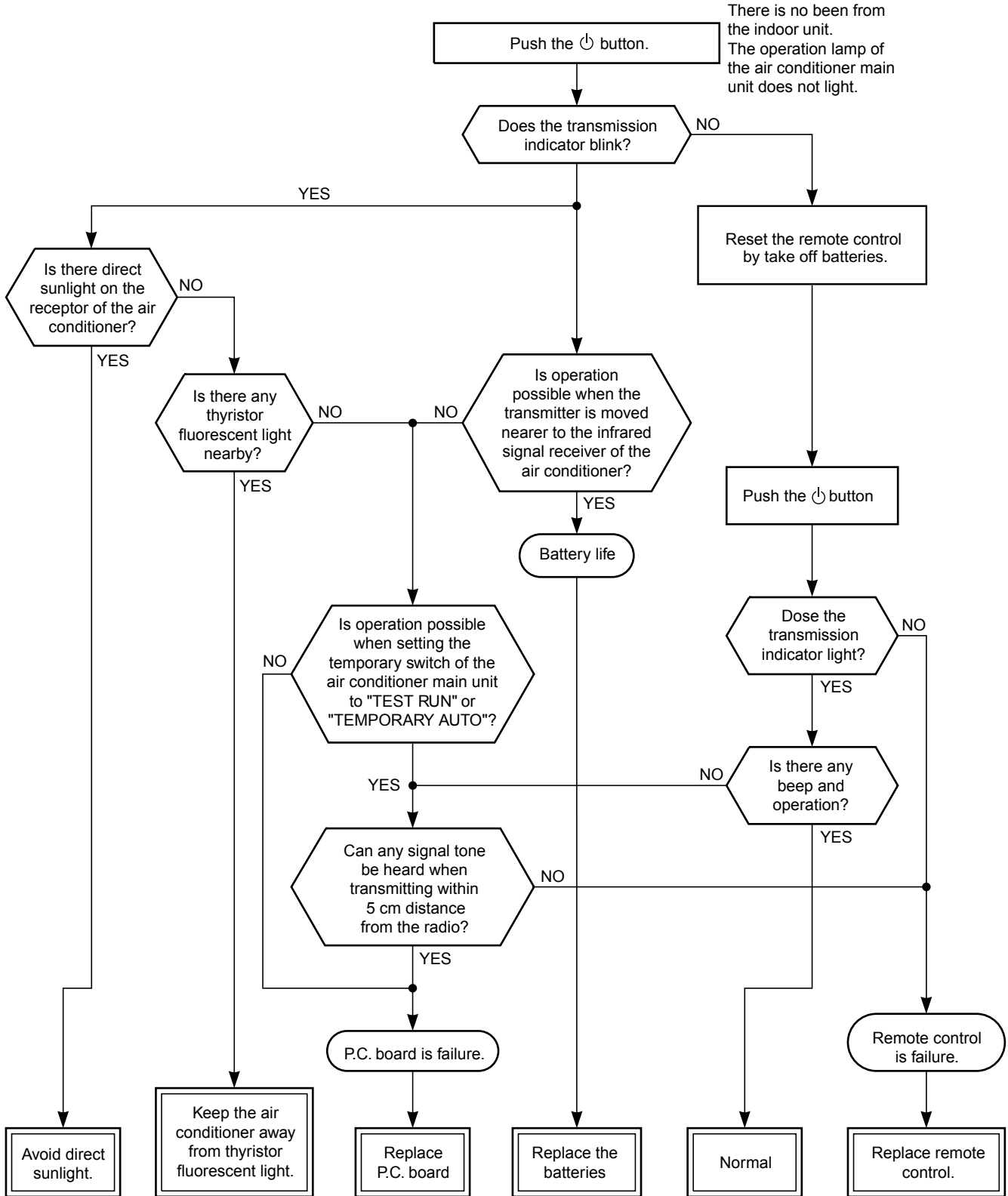

Note: After battery replacement, Shortcircuit the metal terminal at the side of the battery compartment

**9-5-6. Only 4-Way valve does not operate (During heating operation)
Heat Pump Model**

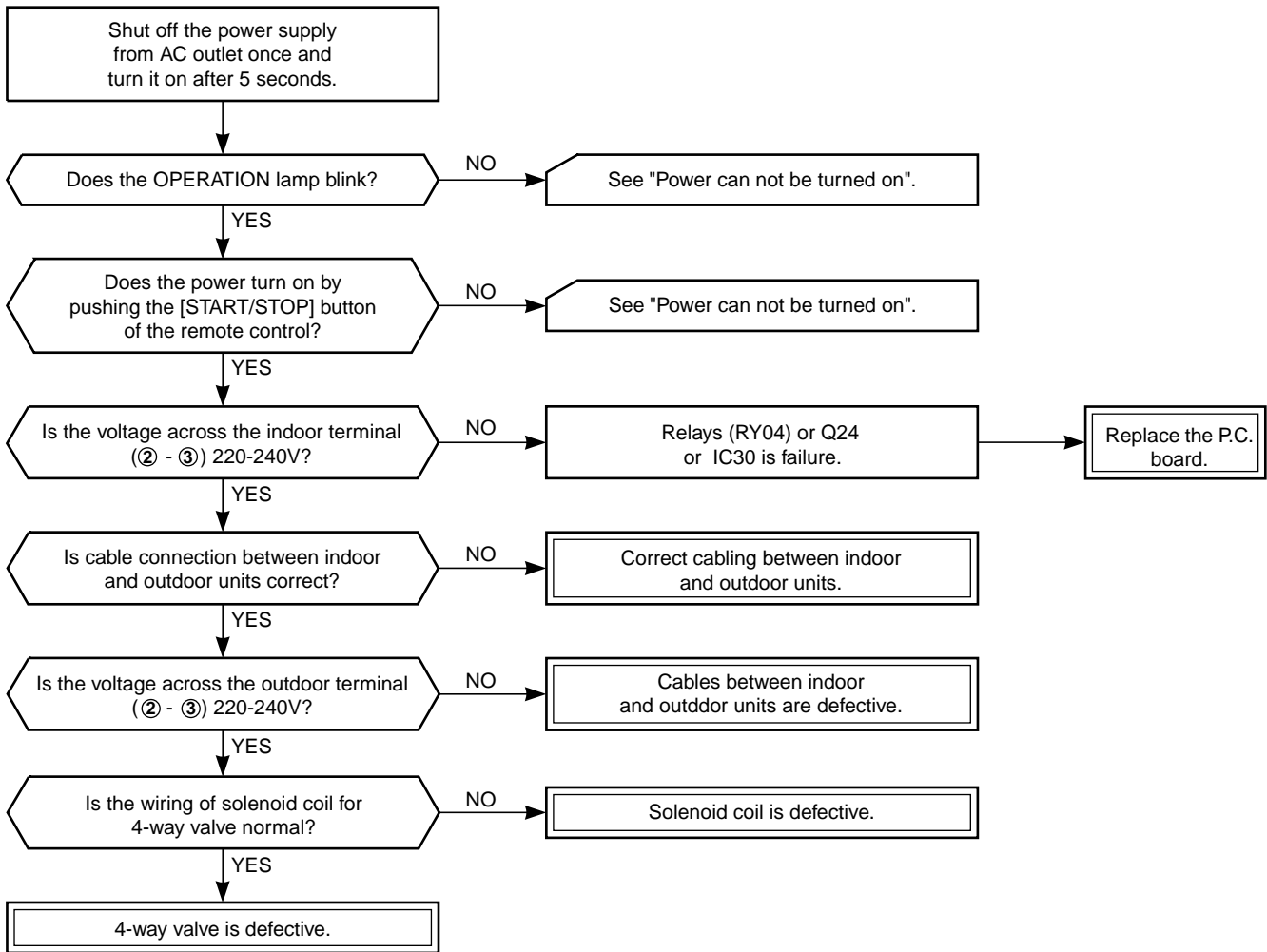

9-6-1 How to check the P.C. board

(1) Operating precautions

- 1) When removing the front panel or the P.C. board, be sure to shut off the power supply.
- 2) When removing the P.C. board, hold the edge of the P.C. board and do not apply force to the parts.
- 3) When connecting or disconnecting the connectors on the P.C. board, hold the Whole housing. Do not pull at the lead wire.

(2) Inspection procedres

- 1) When a P.C. board is judged to be defective, check for disconnection, burning, or discoloration of the copper foil pattern or this P.C. board.
- 2) The P.C. board consists of the following 2 parts
 - a. **Main P.C. board part:**
power relay, indoor fan motor drive circuit and control circuit, C.P.U. and peripheral circuits, buzzer drive circuit and buzzer.
 - b. **Infrared rays receive and indication parts:**
Infrared rays receiver unit and LED.

(3) Checking procedure**Cooling Model****Table 9-6-1**

No.	Procedure	Check Point (Symptom)	Causes
1	Shut off the power supply and remove the P.C. board assembly from the electronic parts base. Remove the connecting cable from the terminal block.	1. Is the fuse blown?	1. • Application of shock voltage. • Overload by short-circuit of the parts.
2	Remove the connector for the motor, and turn the power on. If the OPERATION lamp blinks (0.5 sec. : ON, 0.5 sec. : OFF) when the power turning on, the checking points described as 1-4 of right column are not necessary to perform.	Voltage check 1. Between ④ of RY01 and CN31 (AC 220~240V) 2. Between + and - of C27 (DC 310 ~ 340V) 3. Between 5V and GND 4. Between 12V and GND	1. • AC power cord is defective. • Poor contact of the terminal plate. • Miss wiring of the power relay. 2. • Capacitor (C25, C26) is defective. • Line filter (L01) is defective. • Diode (DB01) is defective. 3. IC02 is defective. 4. T01, DB01, R64, C27 are defective.
3	Make the operation status by pushing once the [⏻] button, except the status of [FAN ONLY], [ON TIMER].	Voltage check 1. Voltage of relay coil. (DC 12V) Between pin C of Q02 and GND 2. Between No. 1 and 2 of connecting cable terminal block. (AC 220~240V)	1. Breaking wire of the relay coil, defective relay driver. 2. Poor contact of relay.
4	Start the operation with the system which the time of the restart delay timer is shortened.	1. All indicators light for 3 sec.. 2. Indicators do not indicate normally after approximate 3 sec..	} Defective indicator, or poor housing assembly. (CN14)
5	Make the operation status by pressing once the [⏻] button. 1. The time of the restart delay timer is shortened. 2. Cool operation 3. Air volume [AUTO] 4. Make the setting temperature lower enough than room temperature. 5. Continuous operation.	1. Compressor does not operate. 2. OPERATION lamp blinks.	1. The temperature of the indoor heat exchanger is abnormally lower. 2. Poor contact of the heat exchanger sensor. (The connector is disconnected.) (CN01) 3. Heat exchanger sensor, main P.C. board are defective. (Refer to Table 9-6-2 for the judgment of defective resistance values.) 4. Main P.C. board is defective.
6	Turn the power on after connecting the motor connector. Start the operation with the following condition. 1. Operation [Cooling] 2. Airflow [High fan] 3. Continuous operation	1. Motor does not rotate. (The key operation is accepted.) 2. The Motor rotates, but it vibrates too much.	1. Poor contact of the motor connector. 2. P.C. board is defective.

(3) Checking procedure
Heat Pump Model

Table 9-6-1

No.	Procedure	Check Point (Symptom)	Causes
1	Shut off the power supply and remove the P.C. board assembly from the electronic parts base. Remove the connecting cable from the terminal block.	1. Is the fuse blown?	1. • AC application of shock voltage. • Overload by short-circuit of the parts.
2	Remove the connector for the motor, and turn the power on. If the OPERATION lamp blinks (0.5 sec. : ON, 0.5 sec. : OFF) when the power turning on, the checking points described as 1-4 of right column are not necessary to perform.	Voltage check 1. Between TP1 and N (AC 220~240V) 2. Between + and – of C63 (DC 310 ~ 340V) 3. Between 12V and GND 4. Between 5V and GND	1. • AC power cord is defective. • Poor contact of the terminal plate. • Miss wiring of the power relay. 2. • Capacitor (C01, C02) is defective. • Line filter (L01) is defective. • Resistor (R319) is defective. • Diode (DB01) is defective. 3. M01, DB01, R319, C63 are defective. 4. IC04 are defective.
3	Make the operation status by pushing once the [ϕ] button, except the status of [FAN ONLY], [ON TIMER].	Voltage check 1. Voltage of relay coil. (DC 12V) Between pin 2 of RY01 and GND 2. Between No. 1 and 2 of connecting cable terminal block. (AC 220~240V)	1. defective relay driver. (Q16) 2. Poor contact of relay.
4	Start the operation with the system which the time of the restart delay timer is shortened.	1. All indicators light for 3 sec.. 2. Indicators do not indicate normally after approximate 3 sec..	} Defective indicator, or poor housing assembly. (CN14)
5	Make the operation status by pressing once the [ϕ] button. 1. The time of the restart delay timer is shortened. 2. Cool operation 3. Air volume [AUTO] 4. Make the setting temperature lower enough than room temperature. 5. Continuous operation.	1. Compressor does not operate. 2. OPERATION lamp blinks.	1. The temperature of the indoor heat exchanger is abnormally lower. 2. Poor contact of the heat exchanger sensor. (The connector is disconnected.) (CN01) 3. Heat exchanger sensor, main P.C. board are defective. (Refer to Table 9-6-2 for the judgment of defective resistance values.) 4. Main P.C. board is defective.
6	The status of No. 5 is continued, and make the following condition. 1. Heat operation 2. Make the setting temperature higher enough than room temperature.	1. Compressor does not operate. 2. OPERATION lamp blinks.	1. The temperature of the heat exchanger is abnormally high. 2. The heat exchanger sensor connector has short-circuit. (CN01) 3. The heat exchanger sensor is defective. (Refer to Table 9-6-2 for the judgment of defective resistance values.) 4. P.C. board is defective.
7	Turn the power on after connecting the motor connector. Start the operation with the following condition. 1. Operation [Cooling] 2. Airflow [High fan] 3. Continuous operation	1. Motor does not rotate. (The key operation is accepted.) 2. The Motor rotates, but it vibrates too much.	1. Poor contact of the motor connector. 2. P.C. board is defective.

Table 9-6-2 Approximate resistance value of thermo sensor

(kΩ)

Temperature	0°C	10°C	20°C	25°C	30°C
Resistance value	33.8	20.35	12.59	10.00	7.99

9-6-2. How to shorten time of restart delay timer

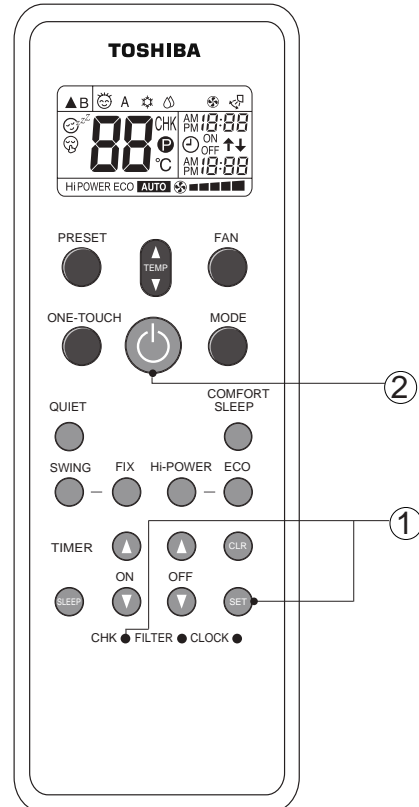

- ① Press [SET] button while pressing [CHK] button with a tip of a pencil.
- ② Then press [⏻] button to transmit the signal to the indoor unit.

**9-6-3. How to set/cancel the self cleaning function**

The self cleaning function is set from a factory. To cancel this function, should keep press the [RESET] button for 20 seconds till can hear the long combination sound and repeat the same procedure when need to set.

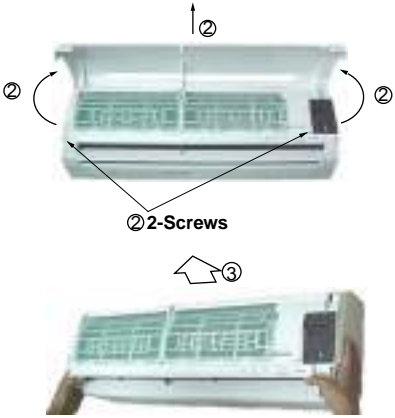
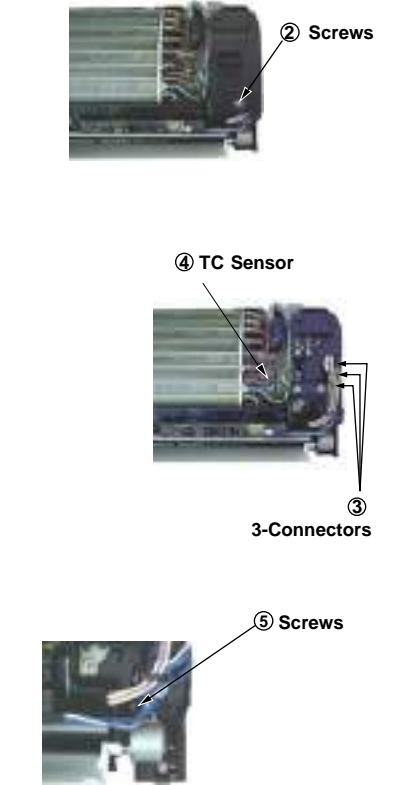

10. PART REPLACEMENT

10-1. Indoor Unit

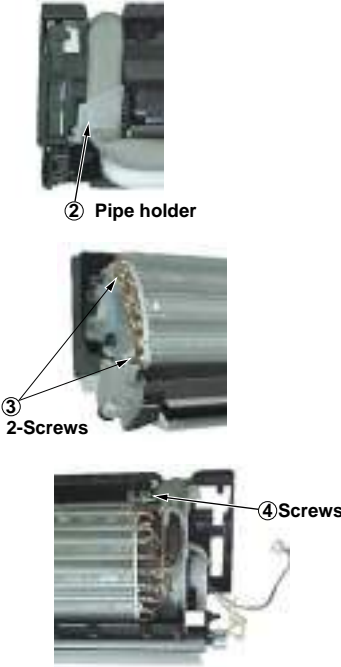
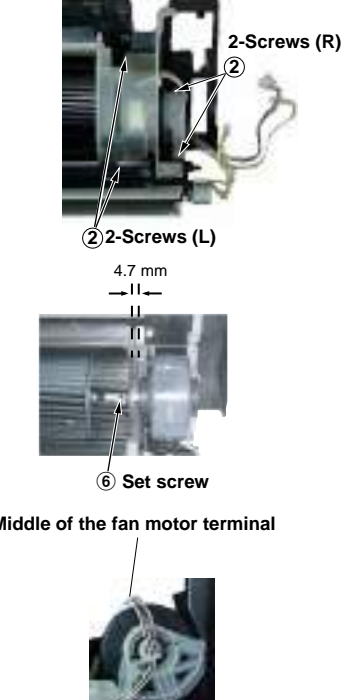
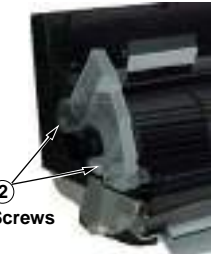
No.	Part name	Procedures	Remarks
①	Front panel	<p>How to remove the front panel</p> <ol style="list-style-type: none"> 1) Stop the operation of the air conditioner and turn off its main power supply. 2) Pull the air inlet grille toward you to open it and remove the air inlet grille. Then remove the 2 screws fixing the front panel. 3) First open the horizontal louver, and then remove the front panel from the back body by pulling it toward you. <p>How to mount the front panel</p> <p>Push the front panel back in and make sure all hooks are locked.</p>	 <p>② 2-Screws</p> <p>③</p>
②	Electrical part	<p>How to remove the electrical part.</p> <ol style="list-style-type: none"> 1) Remove the front panel with procedure ①. 2) Remove the screw holding the electrical part cover. 3) Disconnect the 3 connectors 2-(3P) for the fan motor and the connector (5P) for the louver motor from the P.C. board assembly. 4) Pull out the TC sensor from the sensor holder. 5) Remove the screw for the ground connection, remove the screw for the electrical part box. Then remove the LED and the electrical part box from the main unit. <p>How to mount the electrical part.</p> <ol style="list-style-type: none"> 1) To put back the electrical part box, lock it to the upper hook of the back body. 2) Tighten the screws on the electrical part box. 3) Connect the 3 connectors and arrange the wiring same as original condition and then tighten the screw from the LED unit to the back body. 4) Attach the TC sensor to the holder. 5) Tighten the screw for the ground connection. 6) Tighten the screw on the electrical part cover. 	 <p>② Screws</p> <p>④ TC Sensor</p> <p>③ 3-Connectors</p> <p>⑤ Screws</p>
③	Horizontal louver	<ol style="list-style-type: none"> 1) Remove the front panel and the electrical part following procedure ②. 2) Remove the center shaft of the horizontal louver from the back body. 3) Remove the left shaft from the back body. 4) Remove the horizontal louver from the back body. 	 <p>③ Left shaft</p> <p>② Center shaft</p>

No.	Part name	Procedures	Remarks
④	Heat exchanger	<ol style="list-style-type: none"> 1) Remove the front panel, electrical part and the horizontal louver following procedure ③. 2) Remove the pipe holder at the rear side of main unit. 3) Remove the 2 screws on the heat exchanger at the base bearing. 4) Remove the screw on the heat exchanger at the fixed plate from the back body and then pull out the right hand side until the socket of heat exchanger released from the hook of the band motor (L), and then pull out the upper side of heat exchanger slowly. 	 <p>② Pipe holder</p> <p>③ 2-Screws</p> <p>④ Screws</p>
⑤	Cross flow fan	<ol style="list-style-type: none"> 1) Remove the front panel, electrical part, horizontal louver and the heat exchanger following procedure ④. 2) Remove the 2 screws on the band motor (L) and remove the 2 screws on the band motor (R) and then remove the cross flow fan. 3) Loosen the set screw of the cross flow fan then separate the fan and the fan motor. <p>Notice</p> <p>To assemble cross flow fan and fan motor to the unit, please turn the fan motor unit the center of its terminal meets the top position of band motor (R).</p> <p>Fix the cross flow fan with the set screw at the position where the gap between the back body and the right surface of the cross flow fan is 4.7 mm.</p>	 <p>② 2-Screws (R)</p> <p>② 2-Screws (L)</p> <p>4.7 mm</p> <p>⑥ Set screw</p> <p>Middle of the fan motor terminal</p>
⑥	Base bearing	<ol style="list-style-type: none"> 1) Remove the front panel, electrical part, horizontal louver, heat exchanger and the cross flow fan following procedure ⑤. 2) Remove the 2 screws fixing the base bearing. 3) Remove the bearing from the base bearing. If the housing protrudes from the base bearing, put the housing in position and attach the bearing to the base bearing. 	 <p>② 2-Screws</p>

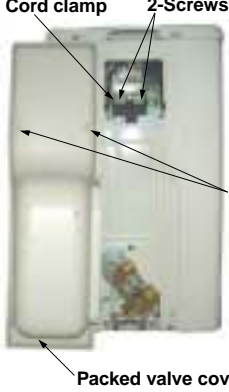
10-2. Outdoor Unit

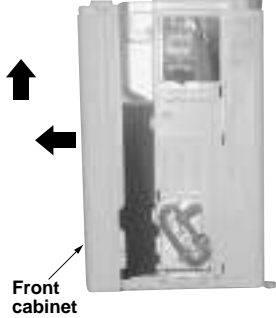
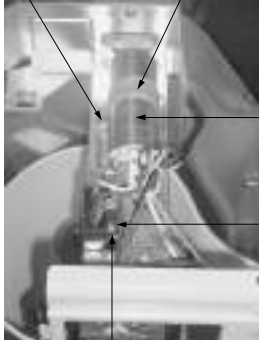
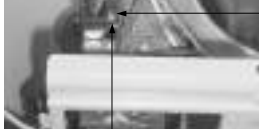
No.	Part name	Procedures	Remarks
①	Common procedure	<ol style="list-style-type: none"> 1) Stop the operation of air-conditioner, and disconnect the power cord from the AC supply. 2) Remove packed valve cover and Electric parts cover. (2-Screws $\varnothing 4 \times 10L$) 3) Remove the cord clamp (2-Screws $\varnothing 4 \times 16L$) and disconnect the connecting cable. 4) Remove the upper cabinet (5-Screws $\varnothing 4 \times 10L$) Pulling out upward. 5) Remove the front cabinet. (3-Screws $\varnothing 4 \times 10L$) Pull the front right portion toward you, and remove it pulling out upward. 	  
②	Capacitor for compressor	<ol style="list-style-type: none"> 1) Perform the common procedure ①. 2) Remove the fixing screw and the capacitor band. (1-Screw $\varnothing 4 \times 10L$) 3) Disconnect the lead wires. 	
③	Capacitor for fan motor	<ol style="list-style-type: none"> 1) Perform the common procedure ①. 2) Remove the fixing screw and the capacitor band. (1-Screw $\varnothing 4 \times 10L$) 3) Disconnect the lead wires. 	

11. EXPLODED VIEWS AND PARTS LIST

11-1. Indoor Unit (E-Parts Assy)

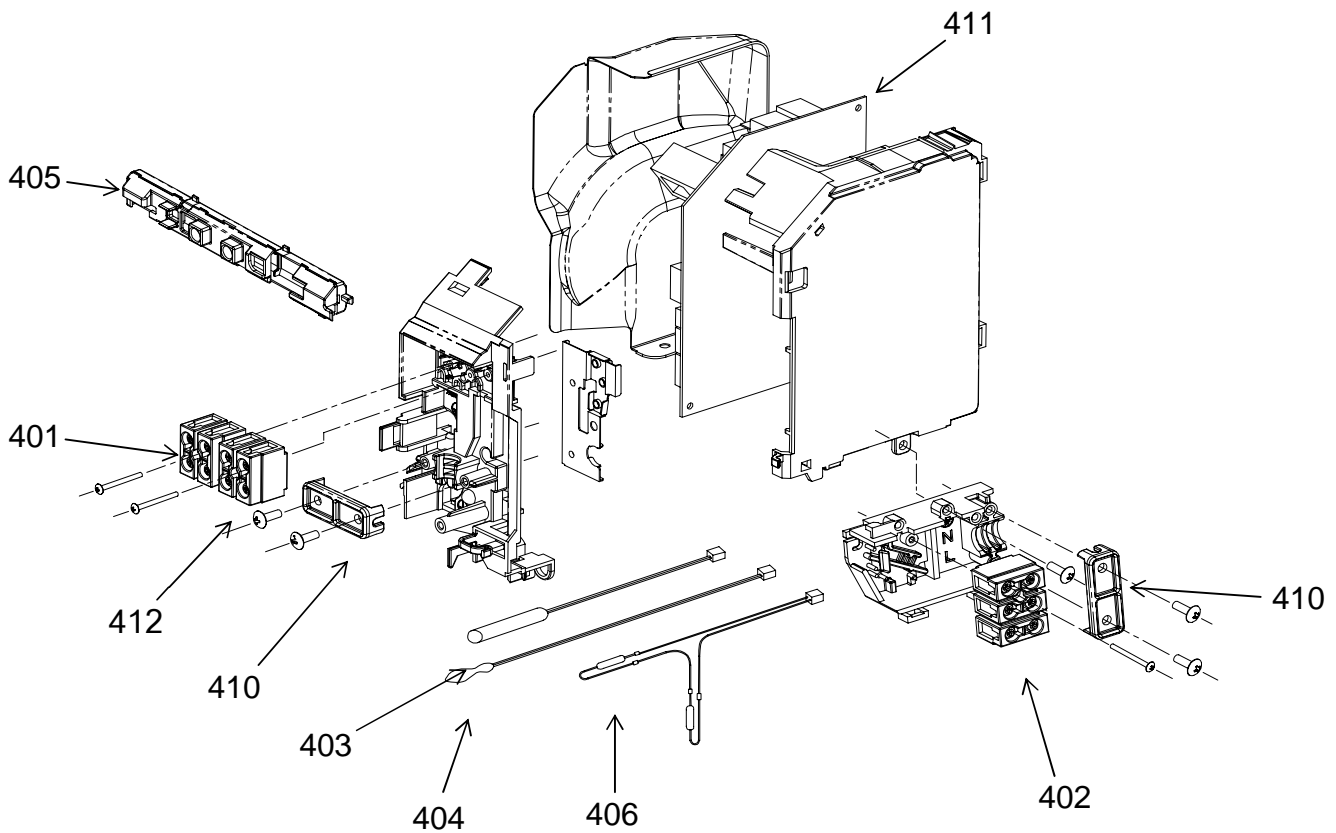

Location No.	Part No.	Description	Location No.	Part No.	Description
401	43T60378	TERMINAL	405	43T69612	DISPLAY UNIT
402	43T60394	TERMINAL	406	43T60077	FUSE, TEMPERATURE, 73C
403	43T69371	SENSOR;HEAT EXCHANGER	410	43T62003	CORD CLAMP
404	43T50314	SENSOR;THERMOSTAT (For 10SKHP-ES)	411	43T69626	PC BOARD (For 10SKHP-ES)
404	43T69005	SENSOR;THERMOSTAT (For 10SKP-ES)	411	43T69714	PC BOARD (For 10SKP-ES)
			412	43T60379	TERMINAL

11-2. Indoor Unit

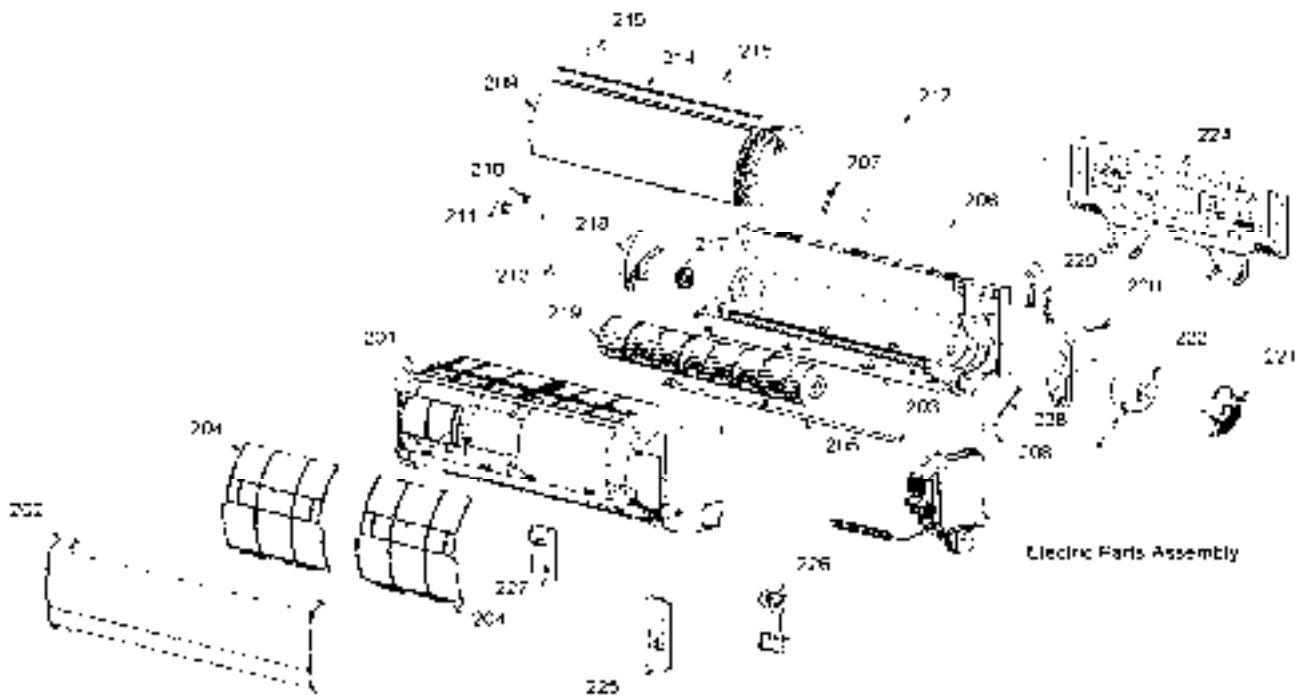

Location No.	Part No.	Description	Location No.	Part No.	Description
201	43T00478	FRONT PANEL ASSY	217	43T22312	BEARING ASSY, MOLD
202	43T09434	GRILLE OF AIR INLET	218	43T39323	BEARING BASE
203	43T03358	BACK BODY ASSY	219	43T20323	ASSY CROSS FLOW FAN
204	43T80317	AIR-FILTER	220	43T39324	MOTOR BAND (LEFT)
205	43T09392	HORIZONTAL LOUVER	221	43T39321	MOTOR BAND(RIGHT)
206	43T70313	HOSE, DRAIN	222	43T21409	FAN MOTOR
207	43T79301	CAP-DRAIN (For 10SKHP-ES)	224	43T82309	INSTALLATION PLATE
208	43T21402	MOTOR; STEPPING	225	43T69615	REMOTE CONTROLLER WIRELESS (For 10SKHP-ES)
209	43T44387	REFRIGERATION CYCLE ASSY	225	43T69616	REMOTE CONTROLLER WIRELESS (For 10SKP-ES)
210	43T47353	PIPE; SUCTION	226	43T83003	HOLDER, REMOTE CONTROL
211	43T47355	PIPE; SUCTION	227	43T62326	TERMINAL COVER
212	43T11317	PIPE SHIELD	228	43T60317	CORD MOTOR LOUVER
213	43T19333	HOLDER, SENSOR	229	43T07311	PIPE HOLDER
214	43T49329	PLATE OF EVA SEAL			
215	43T49006	HOLDER FOR PLATE			

11-3. Outdoor Unit (RAS-10S2AH-ES)

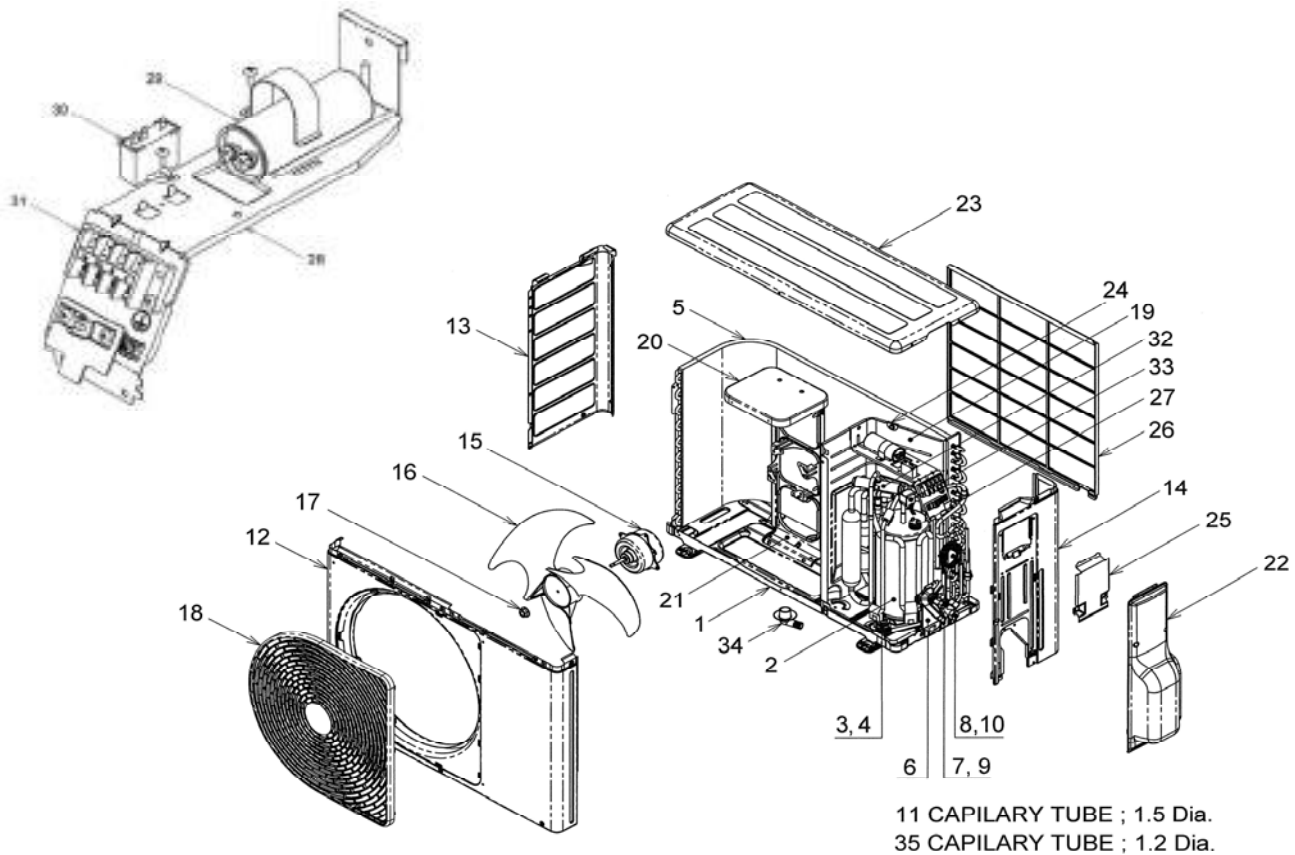

11 CAPILLARY TUBE ; 1.5 Dia.
35 CAPILLARY TUBE ; 1.2 Dia.

Location No.	Part No.	Description	Location No.	Part No.	Description
1	43T42327	BASE PLATE ASSEMBLY	18	43T19329	FAN GUARD
2	43T41379	COMPRESSOR(Made in China)	19	43T04301	PARTITION
3	43T49327	CUSHION,RUBBER	20	43T39333	MOTOR BASE CONNECTION PLATE
4	43T97001	NUT	21	43T39318	MOTOR BASE
5	43T43397	CONDENSER ASSEMBLY	22	43T19330	PACKED VALVE COVER
6	43T00448	FIXING PLATE VALVE	23	43T00460	UPPER CABINET ASSEMBLY
7	43T46332	VALVE;PACKED 6.35 DIA	24	43T96305	BUSHING
8	43T46331	VALVE;PACKED 9.52 DIA	25	43T62325	ELECTRIC PART COVER
9	43T47331	BONNET, 6.35 DIA	26	43T19331	FIN GUARD
10	43T47332	BONNET, 9.52 DIA	27	43T54303	RELAY;OVERLOAD
11	43T47008	CAPILLARY TUBE; 1.5 DIA	28	43T61308	ELECTRIC PARTS BASE
12	43T00468	FRONT CABINET	29	43T55349	MF CAPACITOR
13	43T00459	LEFT CABINET	30	43T55325	CAPACITOR; PLASTIC-FILM
14	43T00451	RIGHT CABINET ASSEMBLY	31	43T60373	TERMINAL-4P
15	43T21361	FAN-MOTOR	32	43T46343	4 WAY VALVE
16	43T20319	PROPELLER FAN	33	43T63321	SOLINOID COIL
17	43T47001	NUT FLANGE	34	43T79305	DRAIN NIPPLE

11-4. Outdoor Unit (RAS-10SA-ES)

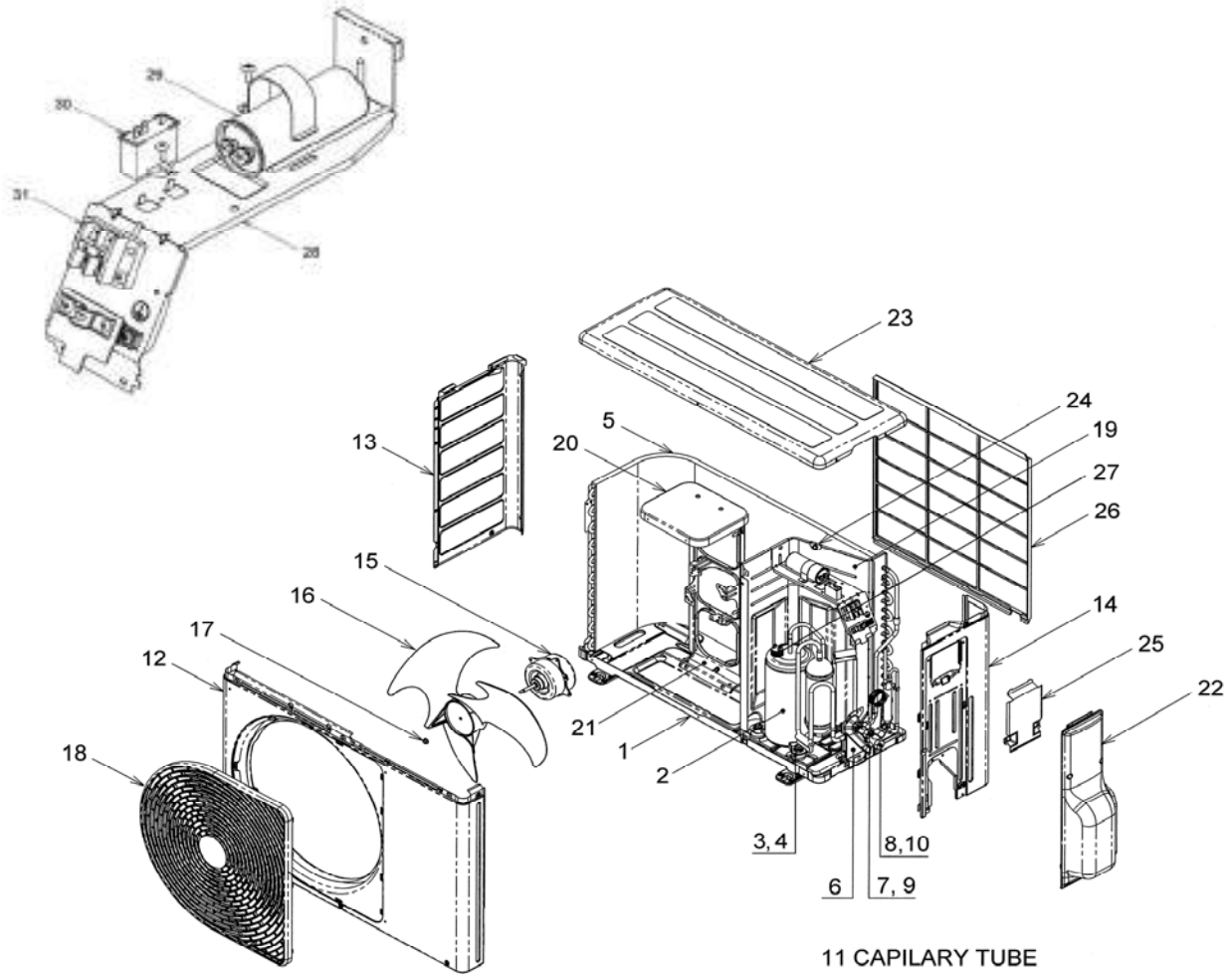

Location No.	Part No.	Description	Location No.	Part No.	Description
1	43T42327	BASE PLATE ASSEMBLY	17	43T47001	NUT FLANGE
2	43T41379	COMPRESSOR(Made in China)	18	43T19329	FAN GUARD
3	43T49327	CUSHION,RUBBER	19	43T04301	PARTITION
4	43T97001	NUT	20	43T39333	MOTOR BASE CONNECTION PLATE
5	43T43396	CONDENSER ASSEMBLY	21	43T39318	MOTOR BASE
6	43T00448	FIXING PLATE VALVE	22	43T19330	PACKED VALVE COVER
7	43T46332	VALVE;PACKED 6.35 DIA	23	43T00460	UPPER CABINET ASSEMBLY
8	43T46331	VALVE;PACKED 9.52 DIA	24	43T96305	BUSHING
9	43T47331	BONNET, 6.35 DIA	25	43T62325	ELECTRIC PART COVER
10	43T47332	BONNET, 9.52 DIA	26	43T19331	FIN GUARD
11	43T47008	CAPILLARY TUBE; 1.5 DIA	27	43T54303	RELAY;OVERLOAD
12	43T00468	FRONT CABINET	28	43T61308	ELECTRIC PARTS BASE
13	43T00459	LEFT CABINET	29	43T55349	MF CAPACITOR
14	43T00451	RIGHT CABINET ASSEMBLY	30	43T55325	CAPACITOR; PLASTIC-FILM
15	43T21341	MOTOR;FAN	31	43T60367	TERMINAL-2P
16	43T20319	PROPELLER FAN			

TOSHIBA CARRIER (THAILAND) CO., LTD.

144/9 MOO 5, BANGKADI INDUSTRIAL PARK, TIVANON ROAD, TAMBOL BANGKADI,
AMPHUR MUANG, PATHUMTHANI 12000, THAILAND.