

TOSHIBA

FILE NO. SVM-12039

SERVICE MANUAL

AIR-CONDITIONER SPLIT TYPE

Indoor Unit

<High Wall, Heat Pump Type>

Outdoor Unit

<Heat Pump Type>

RAS-13N3KV-E

RAS-13N3AV-E

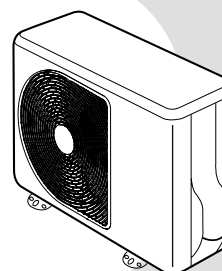
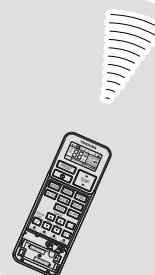

July, 2012

CONTENTS

1. SAFETY PRECAUTIONS	2
2. SPECIFICATIONS	4
3. REFRIGERANT R410A	6
4. CONSTRUCTION VIEWS	14
5. WIRING DIAGRAM	16
6. SPECIFICATIONS OF ELECTRICAL PARTS	17
7. REFRIGERANT CYCLE DIAGRAM	18
8. CONTROL BLOCK DIAGRAM	20
9. OPERATION DESCRIPTION	22
10. INSTALLATION PROCEDURE	47
11. HOW TO DIAGNOSE THE TROUBLE	61
12. HOW TO REPLACE THE MAIN PARTS	83
13. EXPLODED VIEWS AND PARTS LIST	100

1. SAFETY PRECAUTIONS

For general public use

Power supply cord of parts of appliance for outdoor use shall be at least polychloroprene sheathed flexible cord (design H07RN-F) or cord designation 60245 IEC66 (1.5 mm² or more). (Shall be installed in accordance with national wiring regulations.)

CAUTION

New Refrigerant Air Conditioner Installation

- THIS AIR CONDITIONER ADOPTS THE NEW HFC REFRIGERANT (R410A) WHICH DOES NOT DESTROY OZONE LAYER.

R410A refrigerant is apt to be affected by impurities such as water, oxidizing membranes, and oils because the pressure of R410A refrigerant is approx. 1.6 times of refrigerant R22. As well as the adoption of this new refrigerant, refrigerating machine oil has also been changed. Therefore, during installation work, be sure that water, dust, former refrigerant, or refrigerating machine oil does not enter the refrigeration cycle of a new-refrigerant air conditioner. To avoid mixing refrigerant and refrigerating machine oil, the sizes of charging port connecting port connecting sections on the main unit are different from those for the conventional refrigerant, and different size tools are also required. For connecting pipes, use new and clean piping materials with highpressure withstand capabilities, designed for R410A only, and ensure that water or dust does not enter. Moreover, do not use any existing piping as its pressure withstand may be insufficient and may contain impurities.

CAUTION

To disconnect the appliance from the main power supply

This appliance must be connected to the main power supply by means of a circuit breaker or a switch with a contact separation of at least 3 mm in all poles.

The installation circuit breaker must be used specified for the power supply line of this air conditioner.

DANGER

- FOR USE BY QUALIFIED PERSONS ONLY.
- TURN OFF MAIN POWER SUPPLY BEFORE ATTEMPTING ANY ELECTRICAL WORK. MAKE SURE ALL POWER SWITCHES ARE OFF FAILURE TO DO SO MAY CAUSE ELECTRIC SHOCK.
- CONNECT THE CONNECTING CABLE CORRECTLY. IF THE CONNECTING CABLE IS CONNECTED WRONGLY, ELECTRIC PARTS MAY BE DAMAGED.
- CHECK THE EARTH WIRE THAT IT IS NOT BROKEN OR DISCONNECTED BEFORE INSTALLATION.
- DO NOT INSTALL NEAR CONCENTRATIONS OF COMBUSTIBLE GAS OR GAS VAPORS. FAILURE TO FOLLOW THIS INSTRUCTION CAN RESULT IN FIRE OR EXPLOSION.
- TO PREVENT OVERHEATING THE INDOOR UNIT AND CAUSING A FIRE HAZARD, PLACE THE UNIT WELL AWAY (MORE THAN 2 M) FROM HEAT SOURCES SUCH AS RADIATORS, HEATERS, FURNACE, STOVES, ETC.
- WHEN MOVING THE AIR CONDITIONER FOR INSTALLING IT IN ANOTHER PLACE AGAIN, BE VERY CAREFUL NOT TO GET THE SPECIFIED REFRIGERANT (R410A) WITH ANY OTHER GASEOUS BODY INTO THE REFRIGERATION CYCLE. IF AIR OR ANY OTHER GAS IS MIXED IN THE REFRIGERANT, THE GAS PRESSURE IN THE REFRIGERATION CYCLE BECOMES ABNORMALLY HIGH AND IT RESULTINGLY CAUSES BURST OF THE PIPE AND INJURIES ON PERSONS.
- IN THE EVENT THAT THE REFRIGERANT GAS LEAKS OUT OF THE PIPE DURING THE INSTALLATION WORK, IMMEDIATELY LET FRESH AIR INTO THE ROOM. IF THE REFRIGERANT GAS IS HEATED BY FIRE OR SOMETHING ELSE, IT CAUSES GENERATION OF POISONOUS GAS.

WARNING

- Never modify this unit by removing any of the safety guards or bypass or bypass any of the safety interlock switches.
- Do not install in a place which cannot bear the weight of the unit. Personal injury and property damage can result if the unit falls.
- Before doing the electrical work, attach an approved plug to the power supply cord.
Also, make sure the equipment is properly earthed.
- Appliance shall be installed in accordance with national wiring regulations.
If you detect any damage, do not install the unit. Contact your TOSHIBA dealer immediately.
- Do not use any refrigerant different from the one specified for complement or replacement.
Otherwise, abnormally high pressure may be generated in the refrigeration cycle, which may result in a failure or explosion of the product or an injury to your body.

CAUTION

- Exposure of unit to water or other moisture before installation could result in electric shock.
Do not store it in a wet basement or expose to rain or water.
- After unpacking the unit, examine it carefully for possible damage.
- Do not install in a place that can increase the vibration of the unit. Do not install in a place that can amplify the noise level of the unit or where noise and discharged air might disturb neighbors.
- To avoid personal injury, be careful when handling parts with sharp edges.
- Please read this installation manual carefully before installing the unit. It contains further important instructions for proper installation.
- The manufacturer shall not assume any liability for the damage caused by not observing the description of this manual.

2. SPECIFICATIONS

1-1. Specifications

Unit model	Indoor		RAS-13N3KV-E			
	Outdoor		RAS-13N3AV-E			
Cooling capacity			(kW)	3.5		
Cooling capacity range			(kW)	1.1 - 4.0		
Heating capacity			(kW)	4.2		
Heating capacity range			(kW)	0.9 - 5.0		
Power supply	1Ph/50Hz/220-240V, 1Ph/60Hz/220-230V					
Electric characteristic	Indoor	Operation mode		Cooling	Heating	
		Running current	(A)	0.21 - 0.19	0.24 - 0.22	
		Power consumption	(W)	35	40	
		Power factor	(%)	76	76	
	Outdoor	Operation mode		Cooling	Heating	
		Running current	(A)	4.91 - 4.50	5.16 - 4.73	
		Power consumption	(W)	1035	1090	
		Power factor	(%)	96	96	
		Starting current	(A)	5.40		
COP (Cooling / Heating)				3.27/3.72		
Operating noise	Indoor	High	(Cooling / Heating)	(dB-A)	39/40	
		Medium	(Cooling / Heating)	(dB-A)	33/34	
		Low	(Cooling / Heating)	(dB-A)	26/28	
	Outdoor	(Cooling / Heating)		(dB-A)	48/50	
Indoor unit	Unit model		RAS-13N3KV-E			
	Dimension	Height	(mm)	275		
		Width	(mm)	790		
		Depth	(mm)	225		
	Net weight			(kg)	10	
	Fan motor output			(W)	20	
	Air flow rate	(Cooling / Heating)		(m ³ / min)	9.5/10.4	
Outdoor unit	Unit model		RAS-13N3AV-E			
	Dimension	Height	(mm)	550		
		Width	(mm)	780		
		Depth	(mm)	290		
	Net weight			(kg)	33	
	Compressor	Motor output			(W)	750
		Type	Single rotary type with DC-inverter variable speed control			
		Model	DA89X1C-23FZ2			
	Fan motor output			(W)	43	
Air flow rate	(Cooling / Heating)		(m ³ / min)	37.5/37.5		
Piping connection	Type		Flare connection			
	Indoor unit	Liquid side	(mm)	∅6.35		
Gas side		(mm)	∅9.52			
Outdoor unit		Liquid side	(mm)	∅6.35		
		Gas side	(mm)	∅9.52		
Maximum length			(m)	20		
Maximum charge-less length			(m)	15		
Maximum height difference			(m)	10		
Refrigerant	Name of refrigerant		R410A			
	Weight			(kg)	0.8	
Wiring connection	Power supply		3 Wires: Includes earth (Outdoor)			
	Interconnection		4 Wires: Includes earth			
Usable temperature range	Indoor	(Cooling / Heating)	(°C)	21 - 32/0-28		
	Outdoor	(Cooling / Heating)	(°C)	-10-46/-15-24		

* The specification may be subject to change without notice for purpose of improvement.

2-3. Operation Characteristic Curve

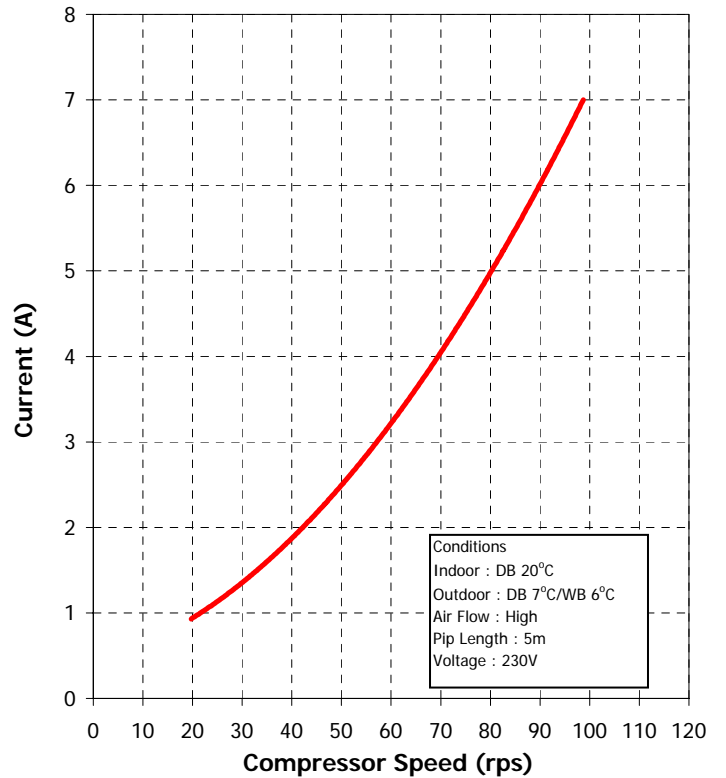
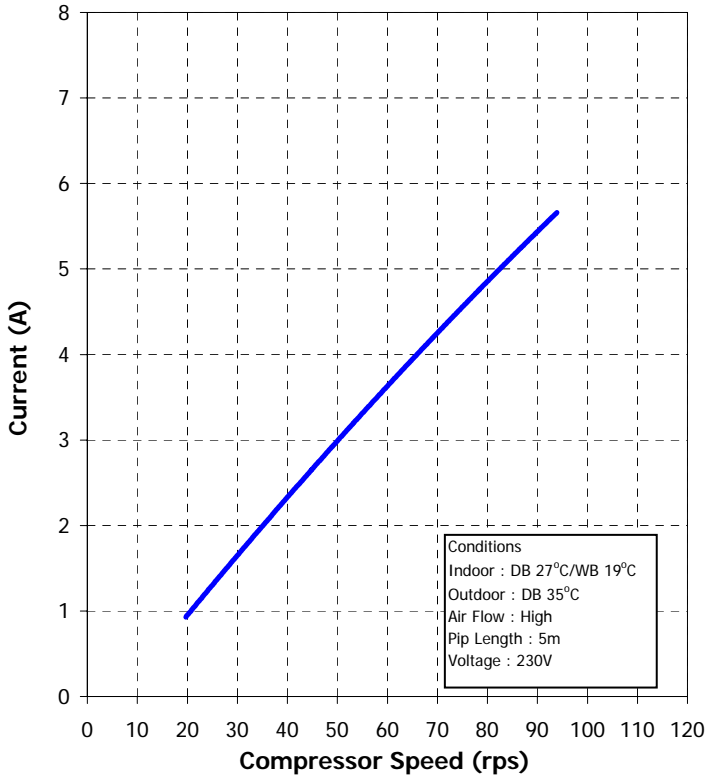

2-4. Capacity Variation Ratio According to Temperature

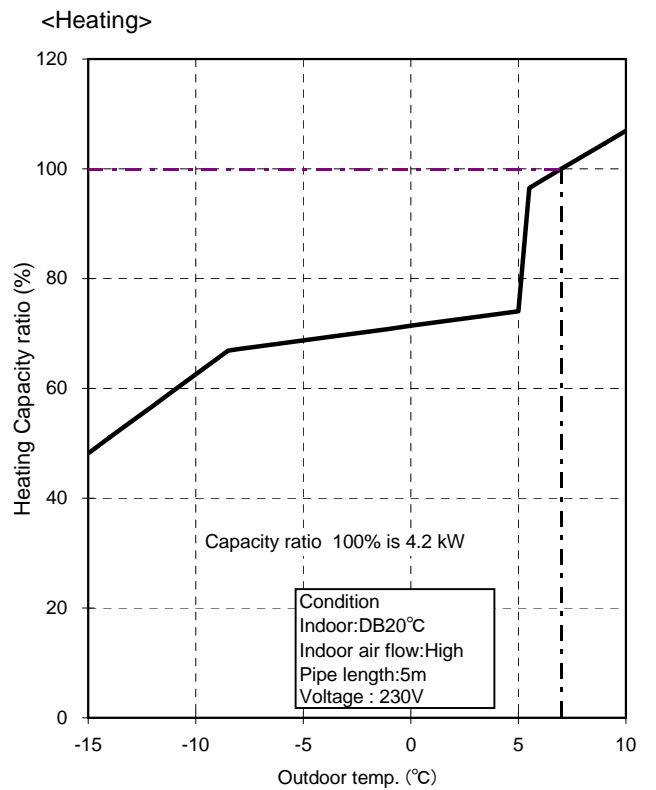
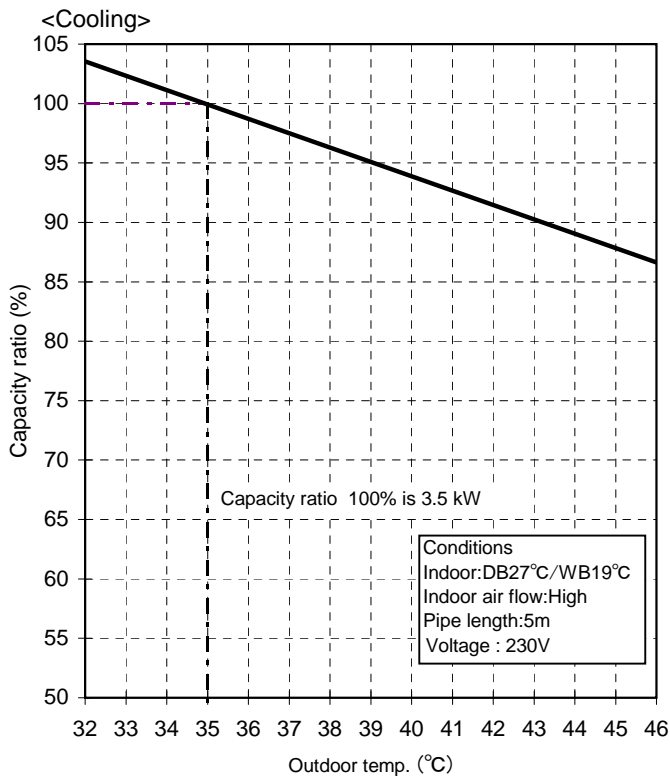

3. REFRIGERANT R410A

This air conditioner adopts the new refrigerant HFC (R410A) which does not damage the ozone layer. The working pressure of the new refrigerant R410A is 1.6 times higher than conventional refrigerant (R22). The refrigerating oil is also changed in accordance with change of refrigerant, so be careful that water, dust, and existing refrigerant or refrigerating oil are not entered in the refrigerant cycle of the air conditioner using the new refrigerant during installation work or servicing time.

The next section describes the precautions for air conditioner using the new refrigerant. Conforming to contents of the next section together with the general cautions included in this manual, perform the correct and safe work.

3-1. Safety During Installation/Servicing

As R410A's pressure is about 1.6 times higher than that of R22, improper installation/servicing may cause a serious trouble. By using tools and materials exclusive for R410A, it is necessary to carry out installation/servicing safely while taking the following precautions into consideration.

1. Never use refrigerant other than R410A in an air conditioner which is designed to operate with R410A.
If other refrigerant than R410A is mixed, pressure in the refrigeration cycle becomes abnormally high, and it may cause personal injury, etc. by a rupture.
2. Confirm the used refrigerant name, and use tools and materials exclusive for the refrigerant R410A.
The refrigerant name R410A is indicated on the visible place of the outdoor unit of the air conditioner using R410A as refrigerant. To prevent mischarging, the diameter of the service port differs from that of R22.
3. If a refrigeration gas leakage occurs during installation/servicing, be sure to ventilate fully.
If the refrigerant gas comes into contact with fire, a poisonous gas may occur.
4. When installing or removing an air conditioner, do not allow air or moisture to remain in the refrigeration cycle. Otherwise, pressure in the refrigeration cycle may become abnormally high so that a rupture or personal injury may be caused.
5. After completion of installation work, check to make sure that there is no refrigeration gas leakage.
If the refrigerant gas leaks into the room, coming into contact with fire in the fan-driven heater, space heater, etc., a poisonous gas may occur.

6. When an air conditioning system charged with a large volume of refrigerant is installed in a small room, it is necessary to exercise care so that, even when refrigerant leaks, its concentration does not exceed the marginal level.
If the refrigerant gas leakage occurs and its concentration exceeds the marginal level, an oxygen starvation accident may result.
7. Be sure to carry out installation or removal according to the installation manual.
Improper installation may cause refrigeration trouble, water leakage, electric shock, fire, etc.
8. Unauthorized modifications to the air conditioner may be dangerous. If a breakdown occurs please call a qualified air conditioner technician or electrician.
Improper repair's may result in water leakage, electric shock and fire, etc.

3-2. Refrigerant Piping Installation

3-2-1. Piping Materials and Joints Used

For the refrigerant piping installation, copper pipes and joints are mainly used. Copper pipes and joints suitable for the refrigerant must be chosen and installed. Furthermore, it is necessary to use clean copper pipes and joints whose interior surfaces are less affected by contaminants.

1. Copper Pipes

It is necessary to use seamless copper pipes which are made of either copper or copper alloy and it is desirable that the amount of residual oil is less than 40 mg/10 m. Do not use copper pipes having a collapsed, deformed or discolored portion (especially on the interior surface).

Otherwise, the expansion valve or capillary tube may become blocked with contaminants.

As an air conditioner using R410A incurs pressure higher than when using R22, it is necessary to choose adequate materials.

Thicknesses of copper pipes used with R410A are as shown in Table 3-2-1. Never use copper pipes thinner than 0.8 mm even when it is available on the market.

Table 3-2-1 Thicknesses of annealed copper pipes

		Thickness (mm)	
Nominal diameter	Outer diameter (mm)	R410A	R22
1/4	6.35	0.80	0.80
3/8	9.52	0.80	0.80
1/2	12.70	0.80	0.80
5/8	15.88	1.00	1.00

2. Joints

For copper pipes, flare joints or socket joints are used. Prior to use, be sure to remove all contaminants.

a) Flare Joints

Flare joints used to connect the copper pipes cannot be used for pipings whose outer diameter exceeds 20 mm. In such a case, socket joints can be used.

Sizes of flare pipe ends, flare joint ends and flare nuts are as shown in Tables 3-2-3 to 3-2-6 below.

b) Socket Joints

Socket joints are such that they are brazed for connections, and used mainly for thick pipings whose diameter is larger than 20 mm.

Thicknesses of socket joints are as shown in Table 3-2-2.

Table 3-2-2 Minimum thicknesses of socket joints

Nominal diameter	Reference outer diameter of copper pipe jointed (mm)	Minimum joint thickness (mm)
1/4	6.35	0.50
3/8	9.52	0.60
1/2	12.70	0.70
5/8	15.88	0.80

3-2-2. Processing of Piping Materials

When performing the refrigerant piping installation, care should be taken to ensure that water or dust does not enter the pipe interior, that no other oil than lubricating oils used in the installed air-water heat pump is used, and that refrigerant does not leak. When using lubricating oils in the piping processing, use such lubricating oils whose water content has been removed. When stored, be sure to seal the container with an airtight cap or any other cover.

1. Flare processing procedures and precautions

a) Cutting the Pipe

By means of a pipe cutter, slowly cut the pipe so that it is not deformed.

b) Removing Burrs and Chips

If the flared section has chips or burrs, refrigerant leakage may occur.

Carefully remove all burrs and clean the cut surface before installation.

c) Insertion of Flare Nut

d) Flare Processing

Make certain that a clamp bar and copper pipe have been cleaned.

By means of the clamp bar, perform the flare processing correctly.

Use either a flare tool for R410A or conventional flare tool.

Flare processing dimensions differ according to the type of flare tool. When using a conventional flare tool, be sure to secure "dimension A" by using a gauge for size adjustment.

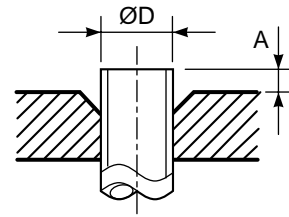

Fig. 3-2-1 Flare processing dimensions

Table 3-2-3 Dimensions related to flare processing for R410A

Nominal diameter	Outer diameter (mm)	Thickness (mm)	A (mm)		
			Flare tool for R410A clutch type	Conventional flare tool	
				Clutch type	Wing nut type
1/4	6.35	0.8	0 to 0.5	1.0 to 1.5	1.5 to 2.0
3/8	9.52	0.8	0 to 0.5	1.0 to 1.5	1.5 to 2.0
1/2	12.70	0.8	0 to 0.5	1.0 to 1.5	2.0 to 2.5
5/8	15.88	1.0	0 to 0.5	1.0 to 1.5	2.0 to 2.5

Table 3-2-4 Dimensions related to flare processing for R22

Nominal diameter	Outer diameter (mm)	Thickness (mm)	A (mm)		
			Flare tool for R22 clutch type	Conventional flare tool	
				Clutch type	Wing nut type
1/4	6.35	0.8	0 to 0.5	0.5 to 1.0	1.0 to 1.5
3/8	9.52	0.8	0 to 0.5	0.5 to 1.0	1.0 to 1.5
1/2	12.70	0.8	0 to 0.5	0.5 to 1.0	1.5 to 2.0
5/8	15.88	1.0	0 to 0.5	0.5 to 1.0	1.5 to 2.0

Table 3-2-5 Flare and flare nut dimensions for R410A

Nominal diameter	Outer diameter (mm)	Thickness (mm)	Dimension (mm)				Flare nut width (mm)
			A	B	C	D	
1/4	6.35	0.8	9.1	9.2	6.5	13	17
3/8	9.52	0.8	13.2	13.5	9.7	20	22
1/2	12.70	0.8	16.6	16.0	12.9	23	26
5/8	15.88	1.0	19.7	19.0	16.0	25	29

Table 3-2-6 Flare and flare nut dimensions for R22

Nominal diameter	Outer diameter (mm)	Thickness (mm)	Dimension (mm)				Flare nut width (mm)
			A	B	C	D	
1/4	6.35	0.8	9.0	9.2	6.5	13	17
3/8	9.52	0.8	13.0	13.5	9.7	20	22
1/2	12.70	0.8	16.2	16.0	12.9	20	24
5/8	15.88	1.0	19.7	19.0	16.0	23	27
3/4	19.05	1.0	23.3	24.0	19.2	34	36

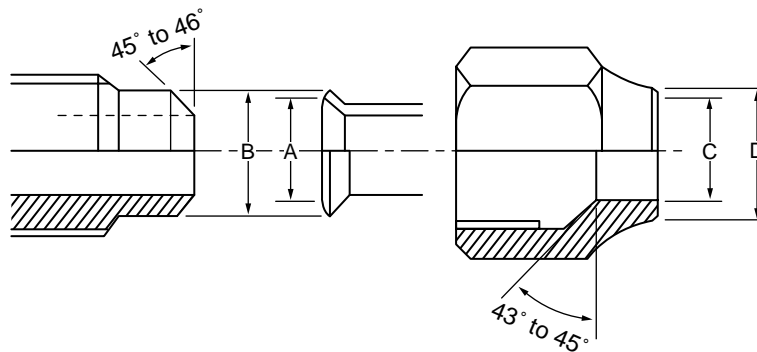

Fig. 3-2-2 Relations between flare nut and flare seal surface

2. Flare Connecting Procedures and Precautions

- a) Make sure that the flare and union portions do not have any scar or dust, etc.
- b) Correctly align the processed flare surface with the union axis.
- c) Tighten the flare with designated torque by means of a torque wrench. The tightening torque for R410A is the same as that for conventional R22. Incidentally, when the torque is weak, the gas leakage may occur. When it is strong, the flare nut may crack and may be made non-removable. When choosing the tightening torque, comply with values designated by manufacturers. Table 3-2-7 shows reference values.

NOTE :

When applying oil to the flare surface, be sure to use oil designated by the manufacturer. If any other oil is used, the lubricating oils may deteriorate and cause the compressor to burn out.

Table 3-2-7 Tightening torque of flare for R410A [Reference values]

Nominal diameter	Outer diameter (mm)	Tightening torque N•m (kgf•cm)	Tightening torque of torque wrenches available on the market N•m (kgf•cm)
1/4	6.35	14 to 18 (140 to 180)	16 (160), 18 (180)
3/8	9.52	33 to 42 (330 to 420)	42 (420)
1/2	12.70	50 to 62 (500 to 620)	55 (550)
5/8	15.88	63 to 77 (630 to 770)	65 (650)

3-3. Tools

3-3-1. Required Tools

The service port diameter of packed valve of the outdoor unit in the air-water heat pump using R410A is changed to prevent mixing of other refrigerant. To reinforce the pressure-resisting strength, flare processing dimensions and opposite side dimension of flare nut (For Ø12.7 copper pipe) of the refrigerant piping are lengthened.

The used refrigerating oil is changed, and mixing of oil may cause a trouble such as generation of sludge, clogging of capillary, etc. Accordingly, the tools to be used are classified into the following three types.

1. Tools exclusive for R410A (Those which cannot be used for conventional refrigerant (R22))
2. Tools exclusive for R410A, but can be also used for conventional refrigerant (R22)
3. Tools commonly used for R410A and for conventional refrigerant (R22)

The table below shows the tools exclusive for R410A and their interchangeability.

Tools exclusive for R410A (The following tools for R410A are required.)

Tools whose specifications are changed for R410A and their interchangeability

No.	Used tool	Usage	R410A air-water heat pump installation		Conventional air-water heat pump installation
			Existence of new equipment for R410A	Whether conventional equipment can be used	Whether new equipment can be used with conventional refrigerant
1	Flare tool	Pipe flaring	Yes	*(Note 1)	○
2	Copper pipe gauge for adjusting projection margin	Flaring by conventional flare tool	Yes	*(Note 1)	*(Note 1)
3	Torque wrench (For Ø12.7)	Connection of flare nut	Yes	×	×
4	Gauge manifold	Evacuating, refrigerant charge, run check, etc.	Yes	×	×
5	Charge hose				
6	Vacuum pump adapter	Vacuum evacuating	Yes	×	○
7	Electronic balance for refrigerant charging	Refrigerant charge	Yes	×	○
8	Refrigerant cylinder	Refrigerant charge	Yes	×	×
9	Leakage detector	Gas leakage check	Yes	×	○
10	Charging cylinder	Refrigerant charge	(Note 2)	×	×

(Note 1) When flaring is carried out for R410A using the conventional flare tools, adjustment of projection margin is necessary. For this adjustment, a copper pipe gauge, etc. are necessary.

(Note 2) Charging cylinder for R410A is being currently developed.

General tools (Conventional tools can be used.)

In addition to the above exclusive tools, the following equipments which serve also for R22 are necessary as the general tools.

- | | | |
|---|-----------------------------|--|
| 1. Vacuum pump
Use vacuum pump by attaching vacuum pump adapter. | 4. Reamer | 9. Hole core drill (Ø65) |
| 2. Torque wrench (For Ø6.35, Ø9.52) | 5. Pipe bender | 10. Hexagon wrench (Opposite side 4mm) |
| 3. Pipe cutter | 6. Level vial | 11. Tape measure |
| | 7. Screwdriver (+, -) | 12. Metal saw |
| | 8. Spanner or Monkey wrench | |

Also prepare the following equipments for other installation method and run check.

- | | |
|----------------|---------------------------------|
| 1. Clamp meter | 3. Insulation resistance tester |
| 2. Thermometer | 4. Electroscop |

3-4. Recharging of Refrigerant

When it is necessary to recharge refrigerant, charge the specified amount of new refrigerant according to the following steps.

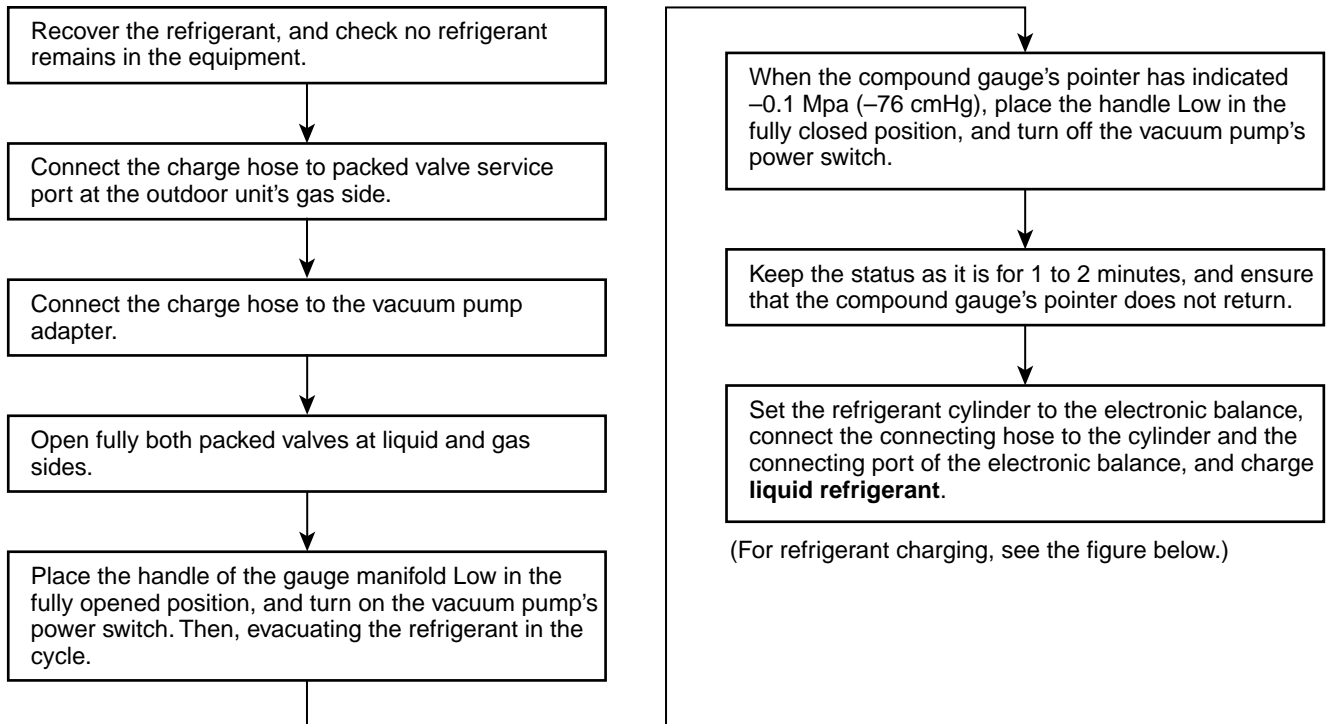

1. Never charge refrigerant exceeding the specified amount.
2. If the specified amount of refrigerant cannot be charged, charge refrigerant **bit by bit** in COOL mode.
3. Do not carry out additional charging.

When additional charging is carried out if refrigerant leaks, the refrigerant composition changes in the refrigeration cycle, that is characteristics of the air conditioner changes, refrigerant exceeding the specified amount is charged, and working pressure in the refrigeration cycle becomes abnormally high pressure, and may cause a rupture or personal injury.

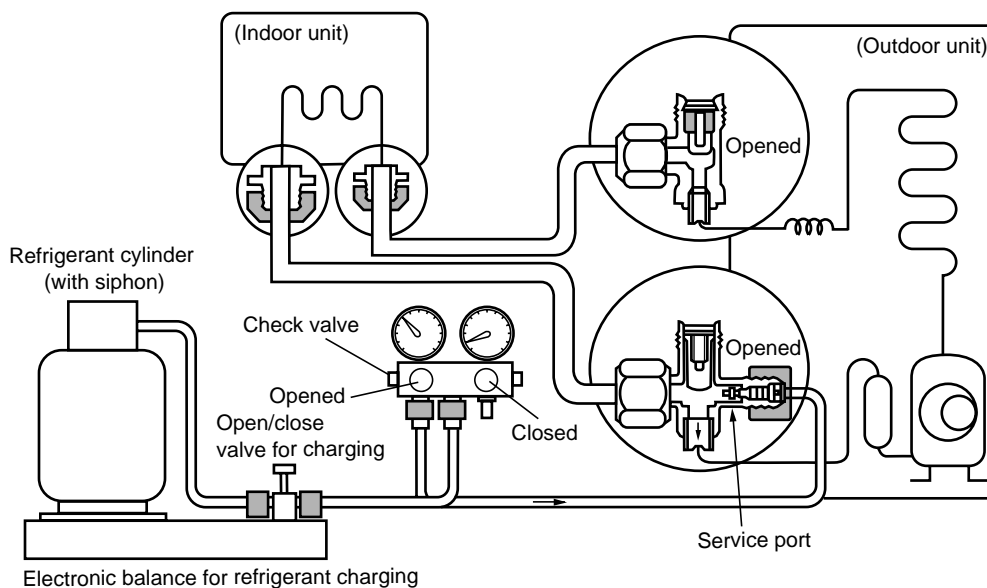
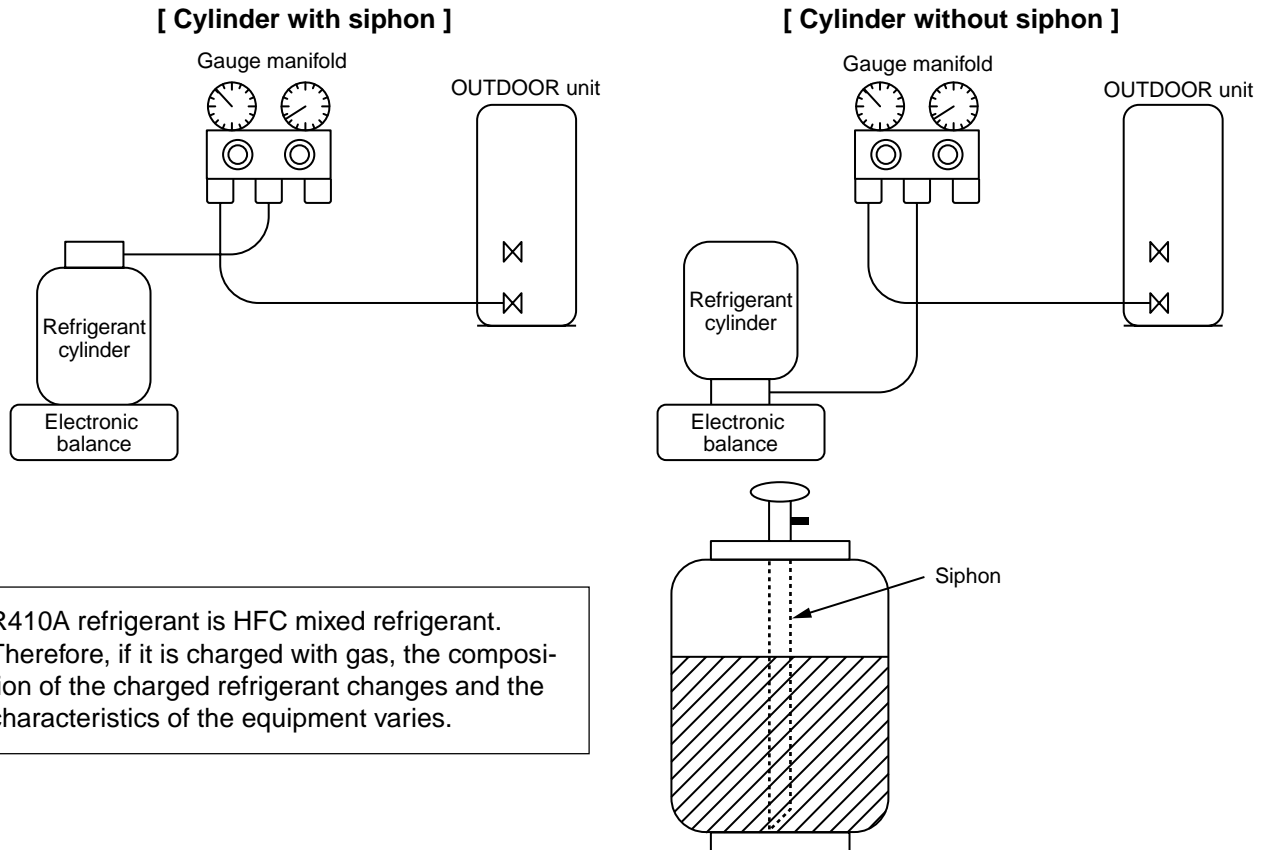

Fig. 3-4-1 Configuration of refrigerant charging

1. Be sure to make setting so that **liquid** can be charged.
2. When using a cylinder equipped with a siphon, liquid can be charged without turning it upside down.

It is necessary for charging refrigerant under condition of liquid because R410A is mixed type of refrigerant. Accordingly, when charging refrigerant from the refrigerant cylinder to the equipment, charge it turning the cylinder upside down if cylinder is not equipped with siphon.



R410A refrigerant is HFC mixed refrigerant. Therefore, if it is charged with gas, the composition of the charged refrigerant changes and the characteristics of the equipment varies.

Fig. 3-4-2

3-5. Brazing of Pipes

3-5-1. Materials for Brazing

1. Silver brazing filler

Silver brazing filler is an alloy mainly composed of silver and copper. It is used to join iron, copper or copper alloy, and is relatively expensive though it excels in solderability.

2. Phosphor bronze brazing filler

Phosphor bronze brazing filler is generally used to join copper or copper alloy.

3. Low temperature brazing filler

Low temperature brazing filler is generally called solder, and is an alloy of tin and lead. Since it is weak in adhesive strength, do not use it for refrigerant pipes.

1. Phosphor bronze brazing filler tends to react with sulfur and produce a fragile compound water solution, which may cause a gas leakage. Therefore, use any other type of brazing filler at a hot spring resort, etc., and coat the surface with a paint.
2. When performing brazing again at time of servicing, use the same type of brazing filler.

3-5-2. Flux

1. Reason why flux is necessary

- By removing the oxide film and any foreign matter on the metal surface, it assists the flow of brazing filler.
- In the brazing process, it prevents the metal surface from being oxidized.
- By reducing the brazing filler's surface tension, the brazing filler adheres better to the treated metal.

2. Characteristics required for flux

- Activated temperature of flux coincides with the brazing temperature.
- Due to a wide effective temperature range, flux is hard to carbonize.
- It is easy to remove slag after brazing.
- The corrosive action to the treated metal and brazing filler is minimum.
- It excels in coating performance and is harmless to the human body.

As the flux works in a complicated manner as described above, it is necessary to select an adequate type of flux according to the type and shape of treated metal, type of brazing filler and brazing method, etc.

3. Types of flux

• Noncorrosive flux

Generally, it is a compound of borax and boric acid.

It is effective in case where the brazing temperature is higher than 800°C.

• Activated flux

Most of fluxes generally used for silver brazing are this type.

It features an increased oxide film removing capability due to the addition of compounds such as potassium fluoride, potassium chloride and sodium fluoride to the borax-boric acid compound.

4. Piping materials for brazing and used brazing filler/flux

Piping material	Used brazing filler	Used flux
Copper - Copper	Phosphor copper	Do not use
Copper - Iron	Silver	Paste flux
Iron - Iron	Silver	Vapor flux

1. Do not enter flux into the refrigeration cycle.
2. When chlorine contained in the flux remains within the pipe, the lubricating oil deteriorates. Therefore, use a flux which does not contain chlorine.
3. When adding water to the flux, use water which does not contain chlorine (e.g. distilled water or ion-exchange water).
4. Remove the flux after brazing.

3-5-3. Brazing

As brazing work requires sophisticated techniques, experiences based upon a theoretical knowledge, it must be performed by a person qualified.

In order to prevent the oxide film from occurring in the pipe interior during brazing, it is effective to proceed with brazing while letting dry Nitrogen gas (N₂) flow.

Never use gas other than Nitrogen gas.

1. Brazing method to prevent oxidation

- 1) Attach a reducing valve and a flow-meter to the Nitrogen gas cylinder.
- 2) Use a copper pipe to direct the piping material, and attach a flow-meter to the cylinder.
- 3) Apply a seal onto the clearance between the piping material and inserted copper pipe for Nitrogen in order to prevent backflow of the Nitrogen gas.
- 4) When the Nitrogen gas is flowing, be sure to keep the piping end open.
- 5) Adjust the flow rate of Nitrogen gas so that it is lower than 0.05 m³/Hr or 0.02 MPa (0.2kgf/cm²) by means of the reducing valve.
- 6) After performing the steps above, keep the Nitrogen gas flowing until the pipe cools down to a certain extent (temperature at which pipes are touchable with hands).
- 7) Remove the flux completely after brazing.

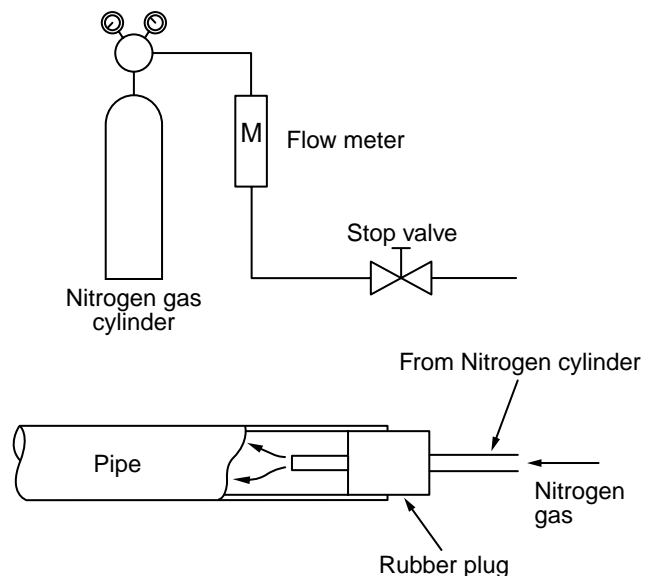
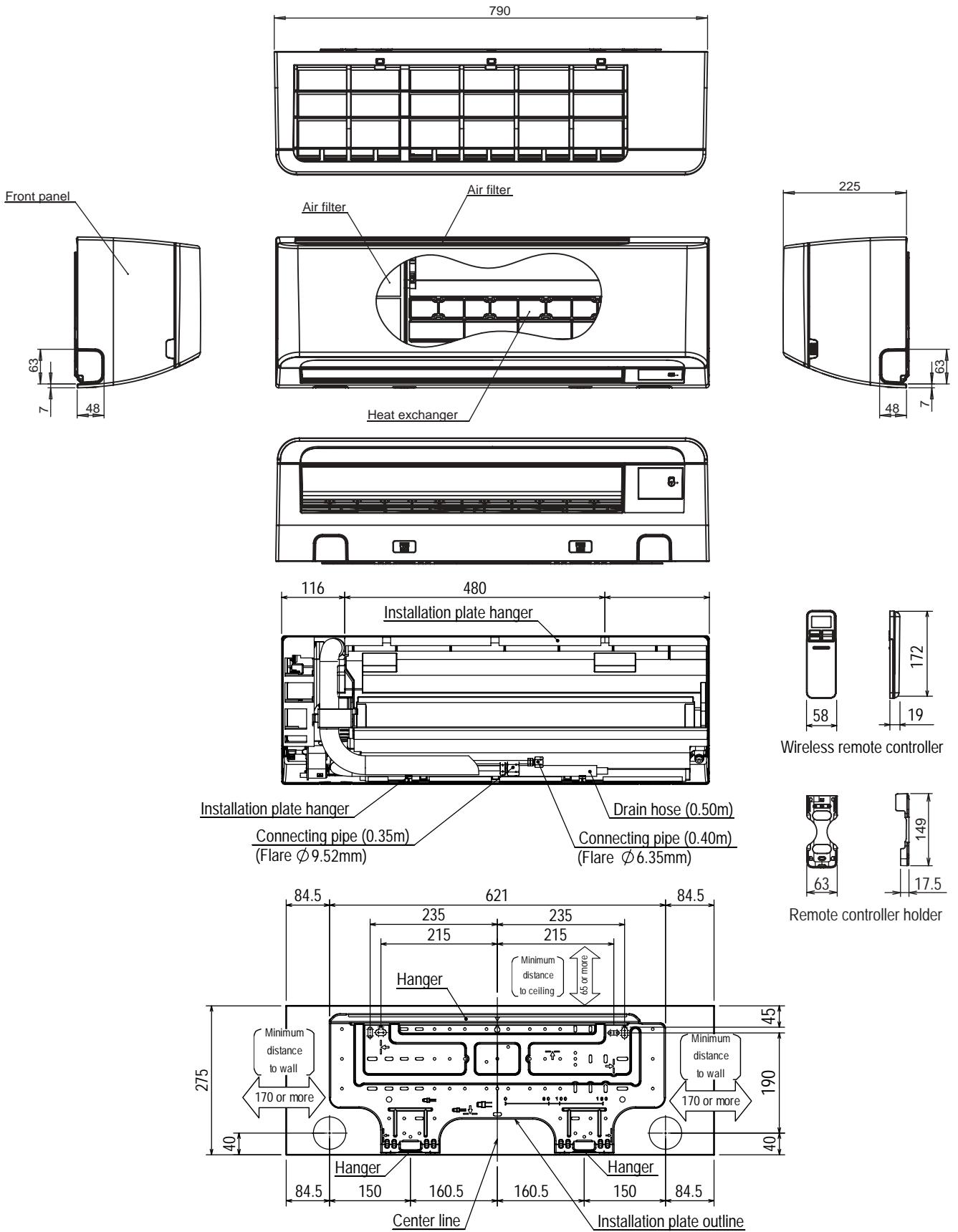

Fig. 3-5-1 Prevention of oxidation during brazing

4. CONSTRUCTION VIEWS

FILE NO. SVM-12039

4-1. Indoor Unit



4-2. Outdoor Unit

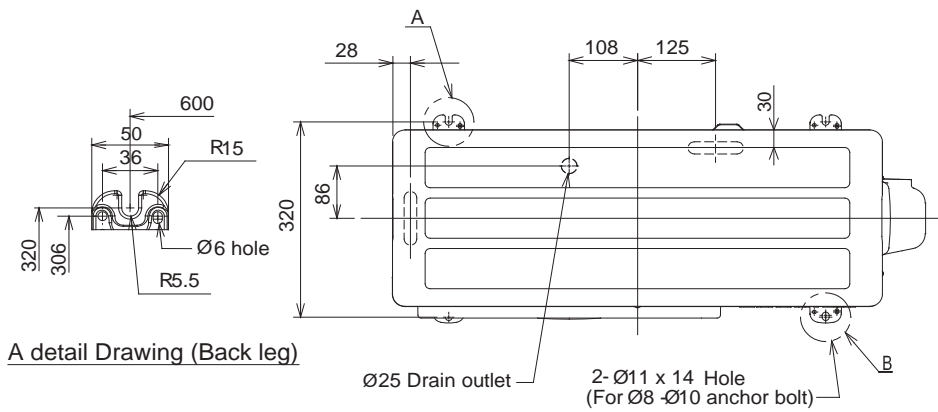

A detail Drawing (Back leg)

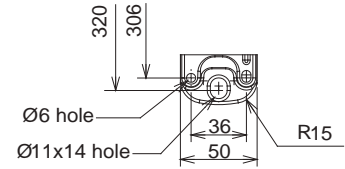

B Detail Drawing (Front leg)

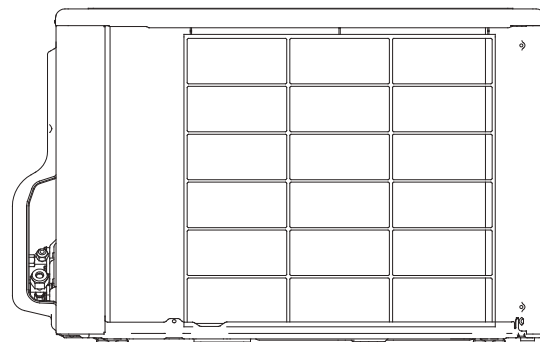
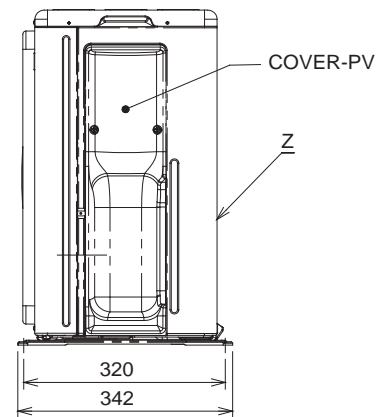
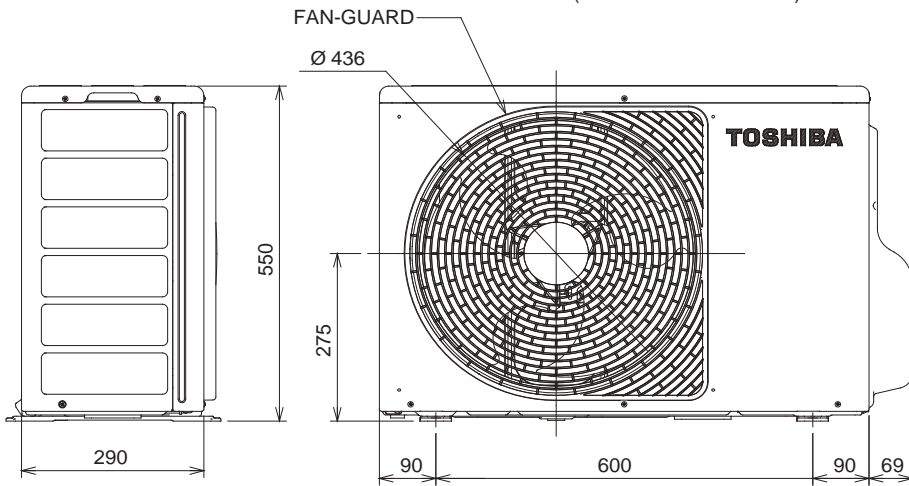

Z View

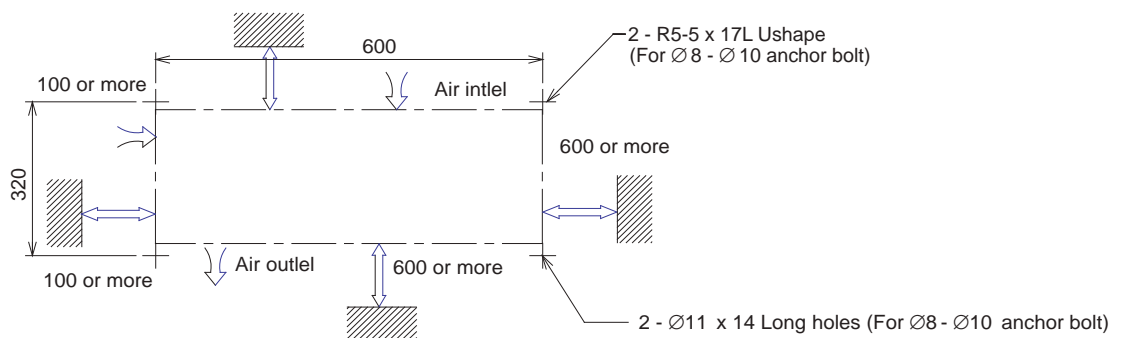
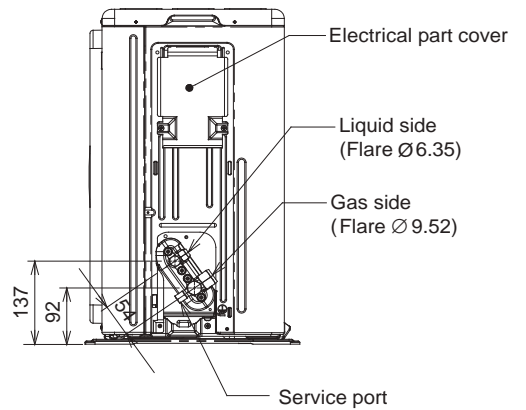

Installation dimension

5. WIRING DIAGRAM

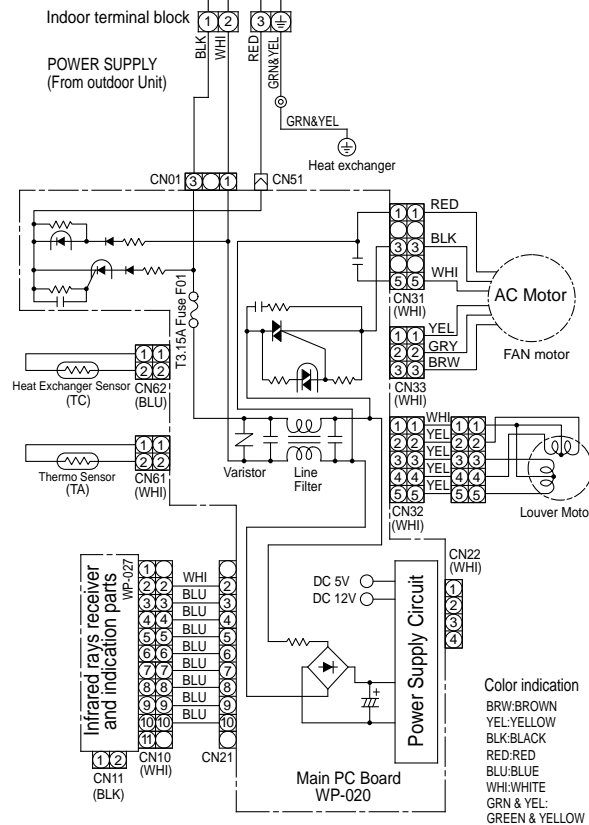
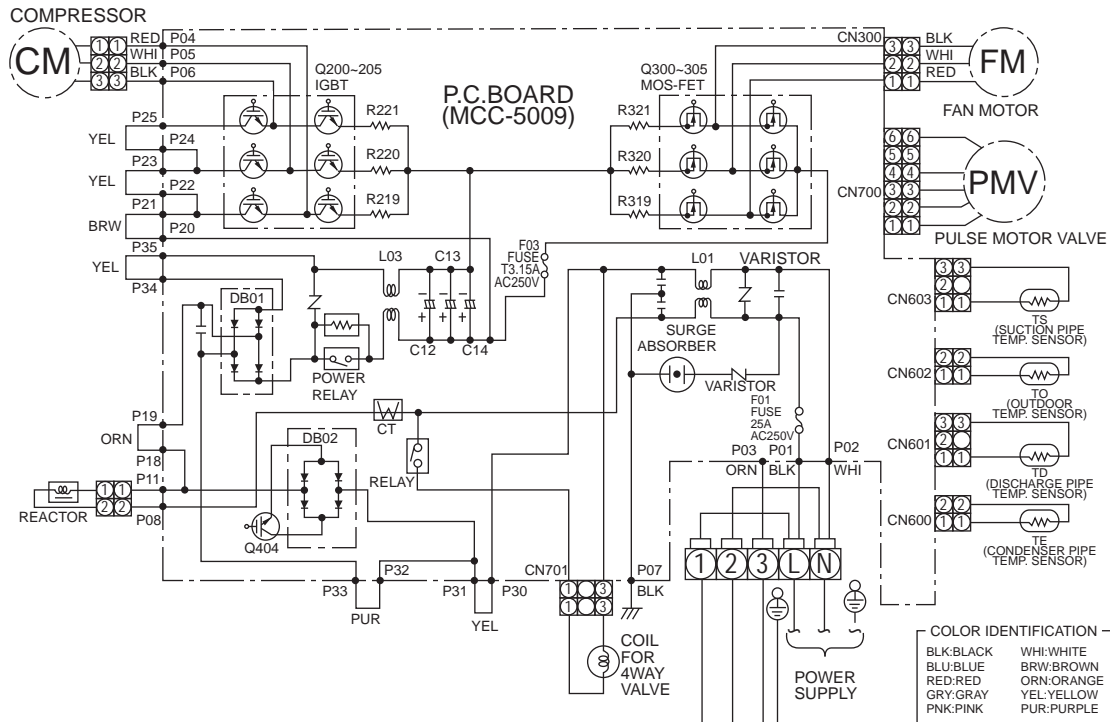

6. SPECIFICATIONS OF ELECTRICAL PARTS

6-1. Indoor Unit

No.	Parts name	Type	Specifications
1	Fan motor (for indoor)	AFN-220-20-4D	AC200~240V, 20W
2	Room temp. sensor (TA-sensor)	(-)	10k Ω at 25°C
3	Heat exchanger temp. sensor (TC-sensor)	(-)	10k Ω at 25°C
4	Louver motor	MSBPC20F04	Output (Rated) 1W, 16 poles, DC12V

6-2. Outdoor Unit

No.	Parts name	Type	Specifications
1	Reactor	CH-69-Z-T	L = 19mH, 10A
2	Outdoor fan motor	ICF-140-43-4R	DC140V, 43W
3	Suction temp. sensor (TS sensor)	(Inverter attached)	10k Ω (25°C)
4	Discharge temp. sensor (TD sensor)	(Inverter attached)	62k Ω (20°C)
5	Outside air temp. sensor (TO sensor)	(Inverter attached)	10k Ω (25°C)
6	Heat exchanger temp. sensor (TE sensor)	(Inverter attached)	10k Ω (25°C)
7	Terminal block (5P)	—————	20A, AC250V
8	Compressor	DA89X1C-23FZ2	3-phases 4-poles 750W
9	COIL FOR P.M.V.	CAM-MD12TCTH-2	DC12V
10	Coil for 4-way valve	STF-01AJ646A1	AC220-240V

7. REFRIGERANT CYCLE DIAGRAM

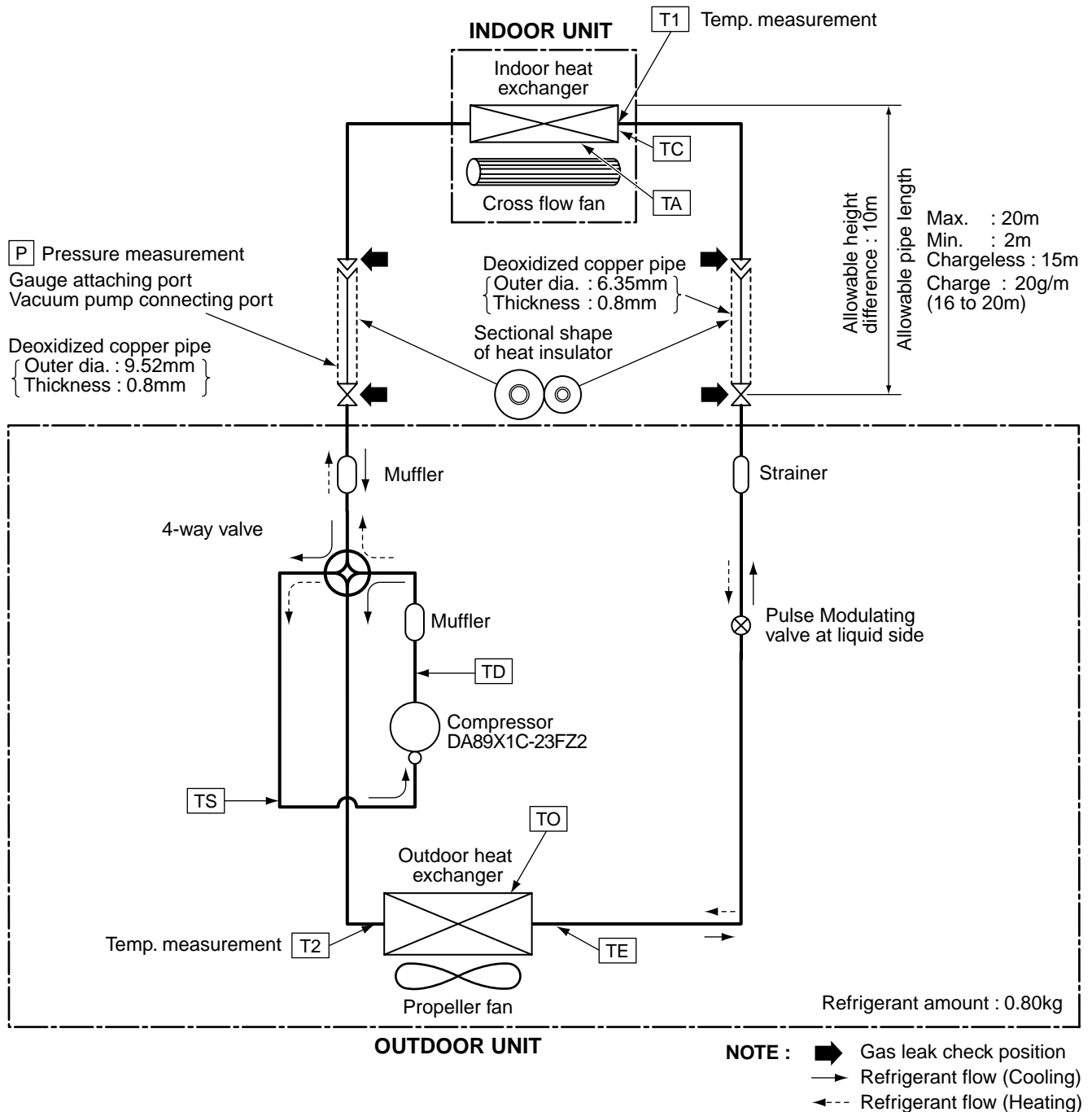

NOTE :

- The maximum pipe length of this air conditioner is 20 m. When the pipe length exceeds 15m, the additional charging of refrigerant, 20g per 1m for the part of pipe exceeded 15m is required. (Max. 100g)

7-2. Operation Data

<Cooling>

Temperature condition(°C)		Standard pressure P (MPa)	Heat exchanger pipe temp.		Indoor fan mode	Outdoor fan mode	Compressor revolution (rps)
Indoor	Outdoor		T1 (°C)	T2 (°C)			
27/19	35/-	0.8 to 1.0	11 to 13	46 to 48	High	High	79

<Heating>

Temperature condition(°C)		Standard pressure P (MPa)	Heat exchanger pipe temp.		Indoor fan mode	Outdoor fan mode	Compressor revolution (rps)
Indoor	Outdoor		T1 (°C)	T2 (°C)			
20/-	7/6	2.6 to 2.8	41 to 43	0 to 2	High	High	83

NOTES :

1. Measure surface temperature of heat exchanger pipe around center of heat exchanger path U bent.
(Thermistor thermometer)
2. Connecting piping condition 5 m

8. CONTROL BLOCK DIAGRAM

8-1. Indoor Unit

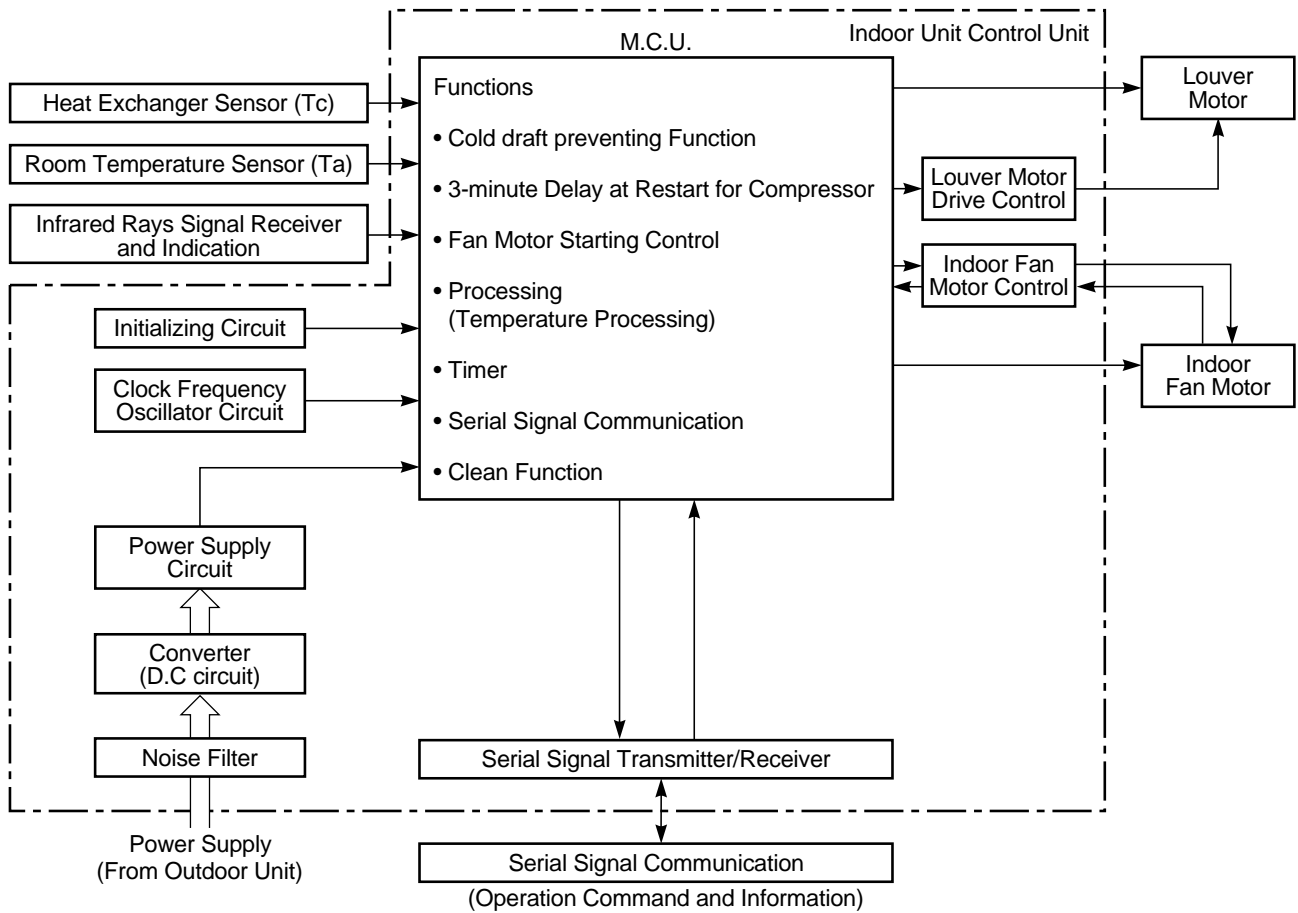

REMOTE CONTROLLER

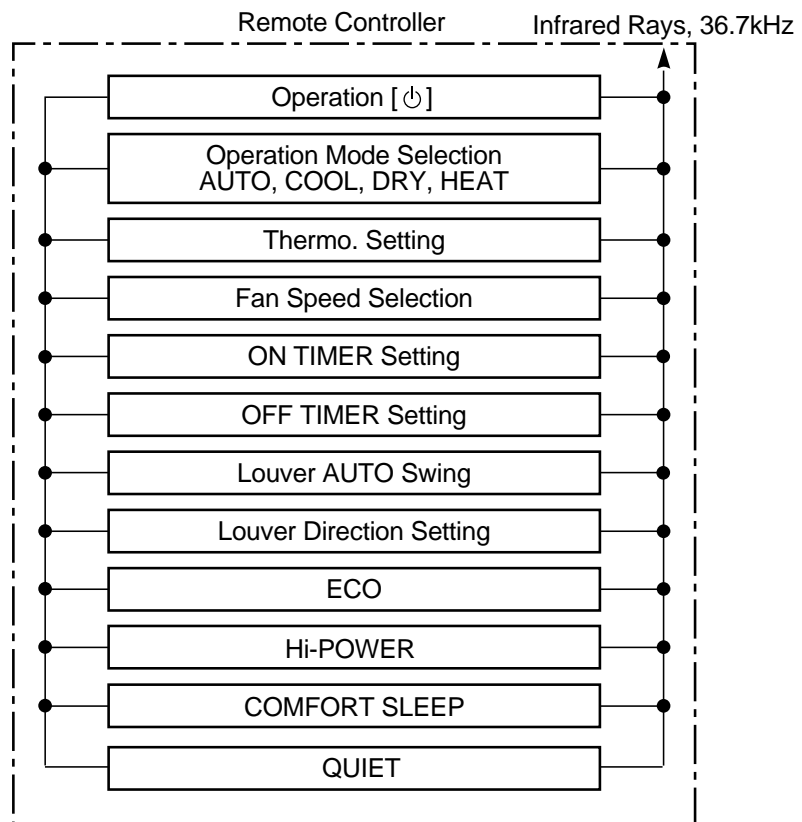

8-2. Outdoor Unit (Inverter Assembly)

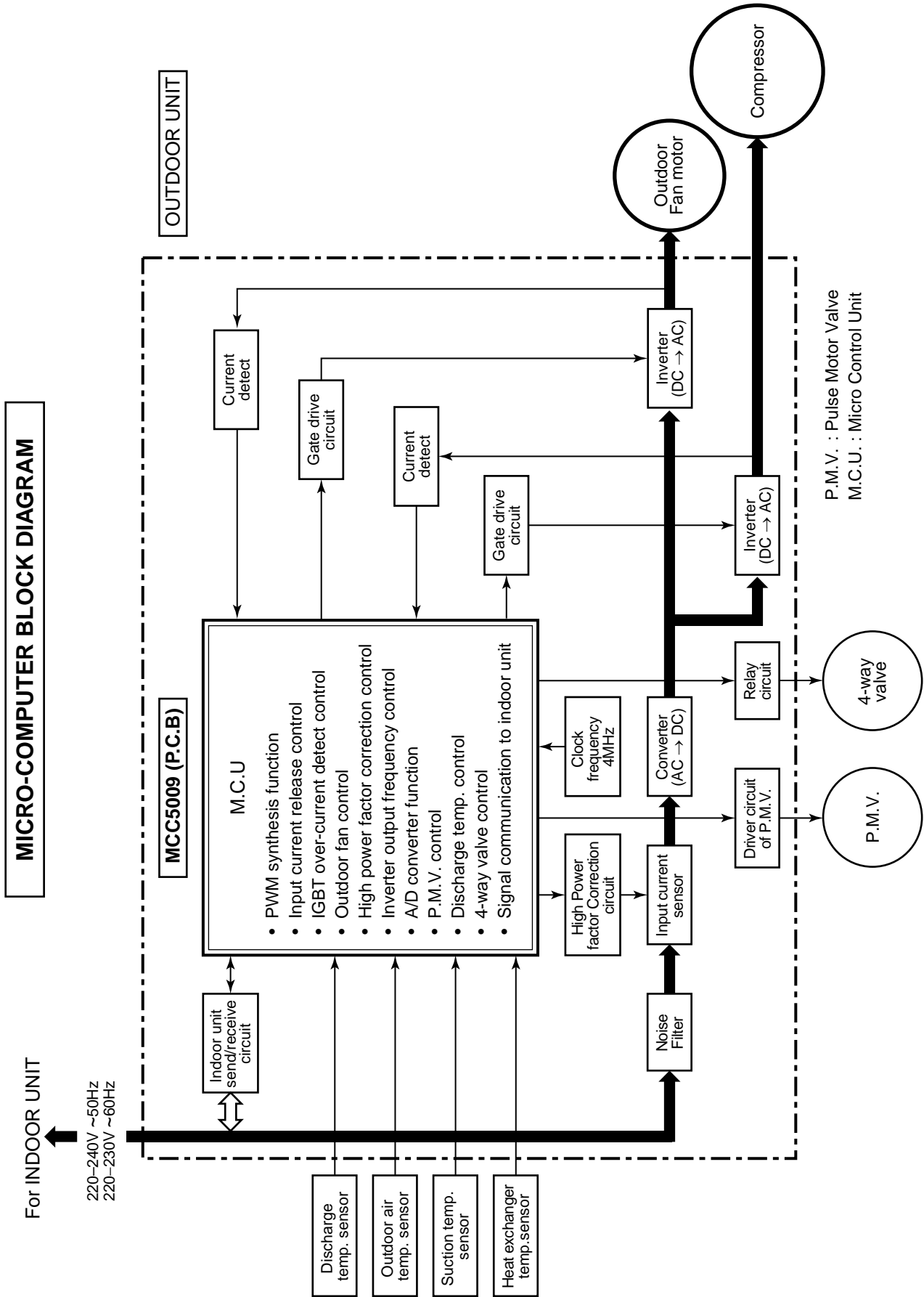

9. OPERATION DESCRIPTION

9-1. Outline of Air Conditioner Control

This air conditioner is a capacity-variable type air conditioner, which uses AC or DC motor for the indoor fan motor and the outdoor fan motor. And the capacity-proportional control compressor which can change the motor speed in the range from 11 to 96 rps is mounted. The DC motor drive circuit is mounted to the indoor unit. The compressor and the inverter to control fan motor are mounted to the outdoor unit.

The entire air conditioner is mainly controlled by the indoor unit controller.

The indoor unit controller drives the indoor fan motor based upon command sent from the remote controller, and transfers the operation command to the outdoor unit controller.

The outdoor unit controller receives operation command from the indoor unit side, and controls the outdoor fan and the pulse Modulating valve. (P.M.V) Besides, detecting revolution position of the compressor motor, the outdoor unit controller controls speed of the compressor motor by controlling output voltage of the inverter and switching timing of the supply power (current transfer timing) so that motors drive according to the operation command.

And then, the outdoor unit controller transfers reversely the operating status information of the outdoor unit to control the indoor unit controller.

As the compressor adopts four-pole brushless DC motor, the frequency of the supply power from inverter to compressor is two-times cycles of the actual number of revolution.

1. Role of indoor unit controller

The indoor unit controller judges the operation commands from the remote controller and assumes the following functions.

- Judgment of suction air temperature of the indoor heat exchanger by using the indoor temp. sensor. (TA sensor)
- Judgment of the indoor heat exchanger temperature by using heat exchanger sensor (TC sensor) (Prevent-freezing control, etc.)
- Louver motor control
- Indoor fan motor operation control
- LED (Light Emitting Diode) display control
- Transferring of operation command signal (Serial signal) to the outdoor unit
- Reception of information of operation status (Serial signal including outside temp. data) to the outdoor unit and judgment/display of error
- Air purifier operation control

2. Role of outdoor unit controller

Receiving the operation command signal (Serial signal) from the indoor unit controller, the outdoor unit performs its role.

- Compressor operation control
 - Operation control of outdoor fan motor
 - P.M.V. control
 - 4-way valve control
- } Operations followed to judgment of serial signal from indoor side.

- Detection of inverter input current and current release operation
- Over-current detection and prevention operation to IGBT module (Compressor stop function)
- Compressor and outdoor fan stop function when serial signal is off (when the serial signal does not reach the board assembly of outdoor control by trouble of the signal system)
- Transferring of operation information (Serial signal) from outdoor unit controller to indoor unit controller
- Detection of outdoor temperature and operation revolution control
- Defrost control in heating operation (Temp. measurement by outdoor heat exchanger and control for 4-way valve and outdoor fan)

3. Contents of operation command signal (Serial signal) from indoor unit controller to outdoor unit controller

The following three types of signals are sent from the indoor unit controller.

- Operation mode set on the remote controller
- Compressor revolution command signal defined by indoor temperature and set temperature (Correction along with variation of room temperature and correction of indoor heat exchanger temperature are added.)
- Temperature of indoor heat exchanger
- For these signals ([Operation mode] and [Compressor revolution] indoor heat exchanger temperature), the outdoor unit controller monitors the input current to the inverter, and performs the followed operation within the range that current does not exceed the allowable value.

4. Contents of operation command signal (Serial signal) from outdoor unit controller to indoor unit controller

The following signals are sent from the outdoor unit controller.

- The current operation mode
 - The current compressor revolution
 - Outdoor temperature
 - Existence of protective circuit operation
- For transferring of these signals, the indoor unit controller monitors the contents of signals, and judges existence of trouble occurrence. Contents of judgment are described below.
- Whether distinction of the current operation status meets to the operation command signal
 - Whether protective circuit operates
- When no signal is received from the outdoor unit controller, it is assumed as a trouble.

9-2. Operation Description

1. Basic operation	24
1. Operation control	24
2. Cooling/Heating operation	25
3. AUTO operation	25
4. DRY operation	25
2. Indoor fan motor control	26
3. Outdoor fan motor control	28
4. Capacity control	29
5. Current release control	29
6. Release protective control by temperature of indoor heat exchanger	30
7. Defrost control (Only in heating operation)	31
8. Louver control	32
1) Louver position	32
2) Air direction adjustment	32
3) Swing	32
9. ECO operation	33
10. Temporary operation	34
11. Discharge temperature control	34
12. Pulse Modulating valve (P.M.V.) control	35
13. Self-Cleaning function	36
14. Remote-A or B selection	38
15. QUIET mode	39
16. COMFORT SLEEP mode	39
17. One-Touch Comfort	39
18. Hi-POWER Mode	40
19. FILTER Indicator	40

9-3. Auto Restart Function

9-3-1. How to Set the Auto Restart Function	41
9-3-2. How to Cancel the Auto Restart Function	42
9-3-3. Power Failure During Timer Operation	42

9-4. Remote Control

9-4-1. Function of push button	43
9-4-2. Operation of remote control	46
9-4-3. Display of remote control	46

Item	Operation flow and applicable data, etc.	Description
<p>1. Basic operation</p>	<p>1. Operation control</p> <p>Receiving the user's operation condition setup, the operation statuses of indoor/outdoor units are controlled.</p> <ol style="list-style-type: none"> 1) The operation conditions are selected by the remote controller as shown in the below. 2) A signal is sent by ON button of the remote controller. 3) The signal is received by a sensor of the indoor unit and processed by the indoor controllers as shown in the below. 4) The indoor controller controls the indoor fan motor and louver motor. 5) The indoor controller sends the operation command to the outdoor controller, and sends/receives the control status with a serial signal. 6) The outdoor controller controls the operation as shown in the left, and also controls the compressor, outdoor fan motor, 4-way valve and pulse Modulating valve. 	

Remote controller

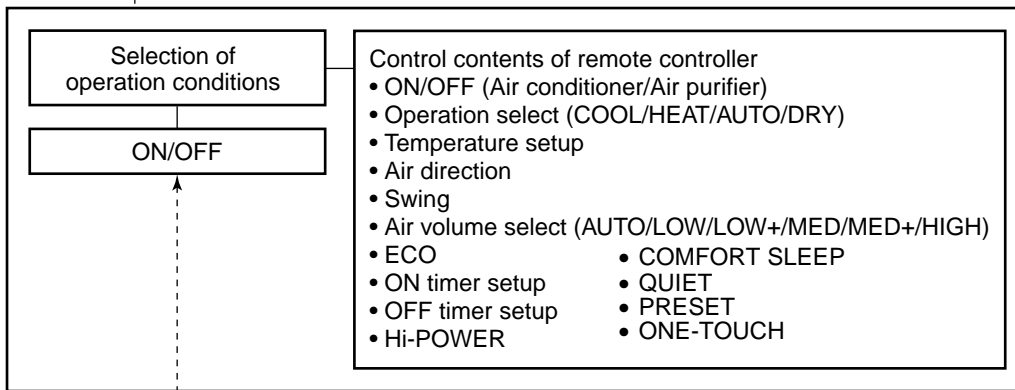

Indoor unit

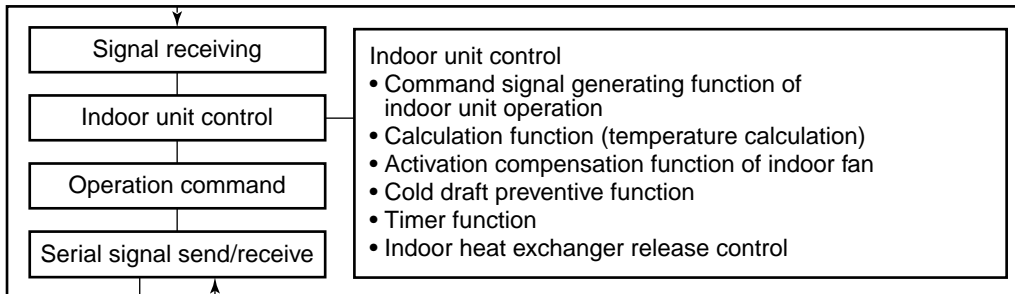

Outdoor unit

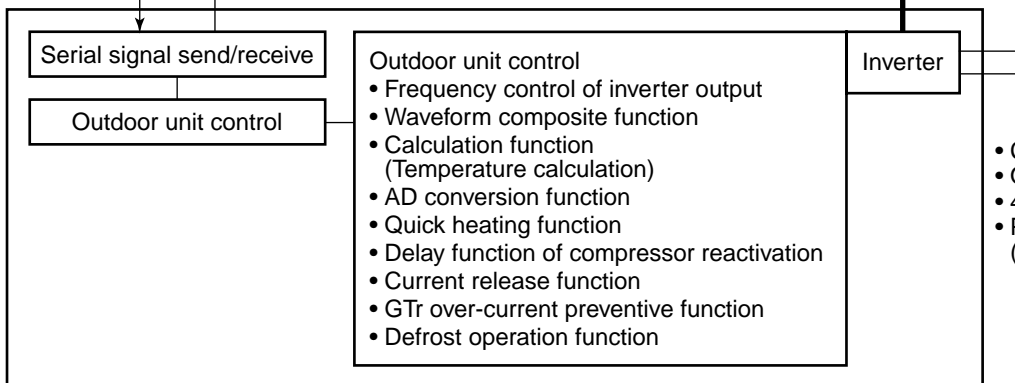

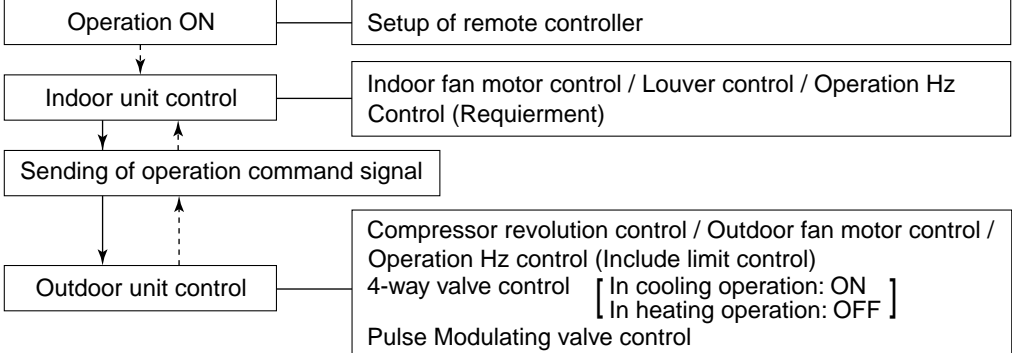
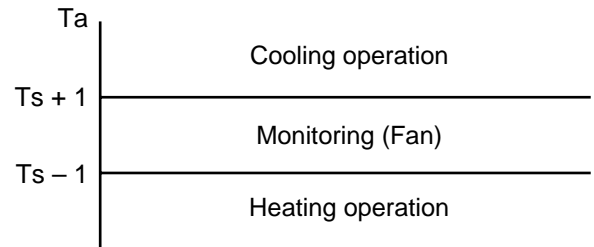
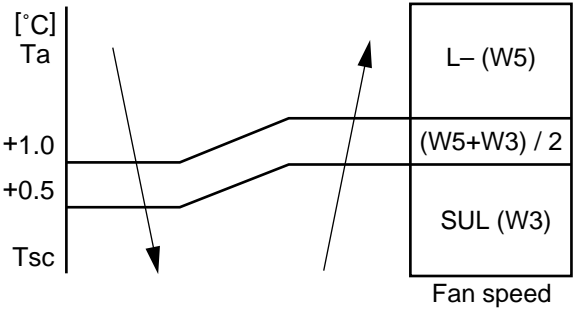
Item	Operation flow and applicable data, etc.	Description
<p>1. Basic operation</p>	<p>2. Cooling/Heating operation</p> <p>The operations are performed in the following parts by controls according to cooling/heating conditions.</p> <ol style="list-style-type: none"> 1) Receiving the operation ON signal of the remote controller, the cooling or heating operation signal starts being transferred from the indoor controller to the outdoor unit. 2) At the indoor unit side, the indoor fan is operated according to the contents of “2. Indoor fan motor control” and the louver according to the contents of “9. Louver control”, respectively. 3) The outdoor unit controls the outdoor fan motor, compressor, pulse Modulating valve and 4-way valve according to the operation signal sent from the indoor unit. 	
	<p>3. AUTO operation</p> <p>Selection of operation mode As shown in the following figure, the operation starts by selecting automatically the status of room temperature (Ta) when starting AUTO operation.</p> <p>*1. When reselecting the operation mode, the fan speed is controlled by the previous operation mode.</p> 	<ol style="list-style-type: none"> 1) Detects the room temperature (Ta) when the operation started. 2) Selects an operation mode from Ta in the left figure. 3) Fan operation continues until an operation mode is selected. 4) When AUTO operation has started within 2 hours after heating operation stopped and if the room temperature is 20°C or more, the fan operation is performed with "Super Ultra LOW" mode for 3 minutes. Then, select an operation mode. 5) If the status of compressor-OFF continues for 15 minutes the room temperature after selecting an operation mode (COOL/HEAT), reselect an operation mode.
	<p>4. DRY operation</p> <p>DRY operation is performed according to the difference between room temperature and the setup temperature as shown below.</p> <p>In DRY operation, fan speed is controlled in order to prevent lowering of the room temperature and to avoid air flow from blowing directly to persons.</p> 	<ol style="list-style-type: none"> 1) Detects the room temperature (Ta) when the DRY operation started. 2) Starts operation under conditions in the left figure according to the temperature difference between the room temperature and the setup temperature (Tsc). Setup temperature (Tsc) = Set temperature on remote controller (Ts) + (0.0 to 1.0) 3) When the room temperature is lower 1°C or less than the setup temperature, turn off the compressor.

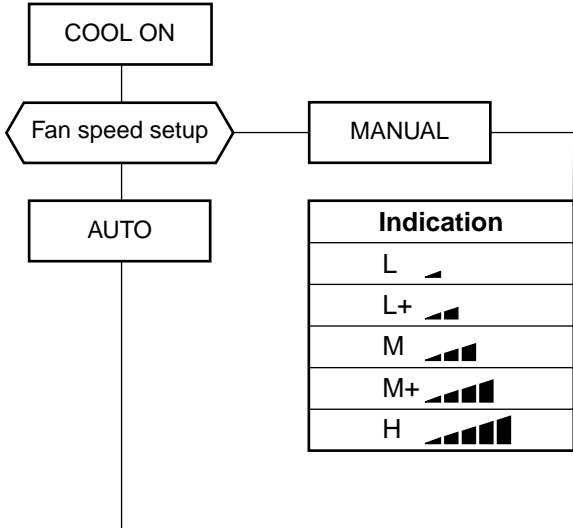
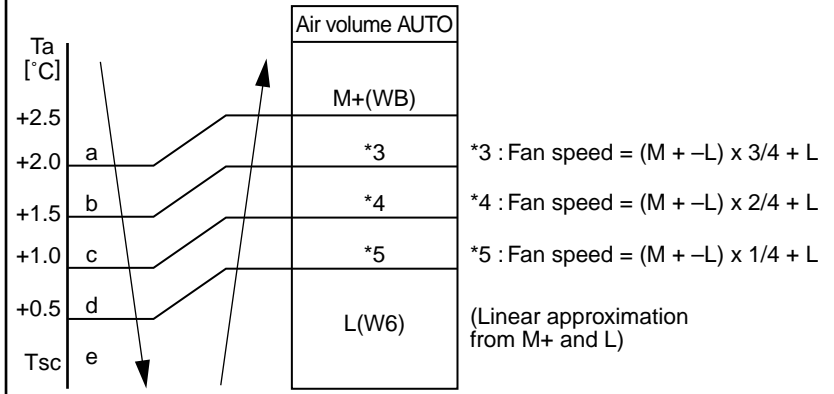
Item	Operation flow and applicable data, etc.	Description																																																																																																
<p>2. Indoor fan motor control</p>	<p><In cooling operation> (This operation controls the fan speed at indoor unit side.) The indoor fan (cross flow fan) is operated by the phase-control induction motor. The fan rotates in 5 stages in MANUAL mode, and in 5 stages in AUTO mode, respectively. (Table 1)</p>	<div style="border: 1px solid black; padding: 5px;"> <p>* Symbols</p> <p>UH : Ultra High H : High M+ : Medium+ M : Medium L+ : Low+ L : Low L- : Low- UL : Ultra Low SUL : Super Ultra Low</p> </div>																																																																																																
	<p>(Fig. 1)</p> <table border="1" data-bbox="470 638 1005 896"> <thead> <tr> <th>Indication</th> <th>Fan speed</th> </tr> </thead> <tbody> <tr> <td>L </td> <td>W6</td> </tr> <tr> <td>L+ </td> <td>(L + M) / 2</td> </tr> <tr> <td>M </td> <td>W9</td> </tr> <tr> <td>M+ </td> <td>(M + H) / 2</td> </tr> <tr> <td>H </td> <td>WC</td> </tr> </tbody> </table> <p>(Fig. 2)</p>	Indication	Fan speed	L	W6	L+	(L + M) / 2	M	W9	M+	(M + H) / 2	H	WC	<p>* The fan speed broadly varies due to position of the louver, etc. The described value indicates one under condition of inclining downward blowing.</p> <p>1) When setting the fan speed to L, L+, M, M+ or H on the remote controller, the operation is performed with the constant speed shown in Fig. 1.</p> <p>2) When setting the fan speed to AUTO on the remote controller, revolution of the fan motor is controlled to the fan speed level shown in Fig. 2 and Table 1 according to the setup temperature, room temperature, and heat exchanger temperature.</p>																																																																																				
Indication	Fan speed																																																																																																	
L	W6																																																																																																	
L+	(L + M) / 2																																																																																																	
M	W9																																																																																																	
M+	(M + H) / 2																																																																																																	
H	WC																																																																																																	
	<table border="1" data-bbox="454 996 1005 1377"> <thead> <tr> <th colspan="2">Air volume AUTO</th> </tr> </thead> <tbody> <tr> <td>M+(WB)</td> <td>*3 : Fan speed = (M + -L) x 3/4 + L</td> </tr> <tr> <td>*4</td> <td>*4 : Fan speed = (M + -L) x 2/4 + L</td> </tr> <tr> <td>*5</td> <td>*5 : Fan speed = (M + -L) x 1/4 + L</td> </tr> <tr> <td>L(W6)</td> <td>(Linear approximation from M+ and L)</td> </tr> </tbody> </table>	Air volume AUTO		M+(WB)	*3 : Fan speed = (M + -L) x 3/4 + L	*4	*4 : Fan speed = (M + -L) x 2/4 + L	*5	*5 : Fan speed = (M + -L) x 1/4 + L	L(W6)	(Linear approximation from M+ and L)																																																																																							
Air volume AUTO																																																																																																		
M+(WB)	*3 : Fan speed = (M + -L) x 3/4 + L																																																																																																	
*4	*4 : Fan speed = (M + -L) x 2/4 + L																																																																																																	
*5	*5 : Fan speed = (M + -L) x 1/4 + L																																																																																																	
L(W6)	(Linear approximation from M+ and L)																																																																																																	
	<p>(Table 1) Indoor fan air flow rate</p> <table border="1" data-bbox="303 1489 877 2027"> <thead> <tr> <th>Fan speed level</th> <th>COOL</th> <th>HEAT</th> <th>DRY</th> <th>Fan speed (rpm)</th> <th>Air flow rate (m3/h)</th> </tr> </thead> <tbody> <tr><td>WF</td><td></td><td>UH</td><td></td><td>1300</td><td>620</td></tr> <tr><td>WE</td><td></td><td>H</td><td></td><td>1300</td><td>620</td></tr> <tr><td>WD</td><td>UH</td><td>M+</td><td>UH</td><td>1250</td><td>590</td></tr> <tr><td>WC</td><td>H</td><td></td><td>H</td><td>1200</td><td>570</td></tr> <tr><td>WB</td><td>M+</td><td>M</td><td>M+</td><td>1080</td><td>490</td></tr> <tr><td>WA</td><td></td><td></td><td>M</td><td>1050</td><td>465</td></tr> <tr><td>W9</td><td>M</td><td>L+</td><td></td><td>990</td><td>434</td></tr> <tr><td>W8</td><td></td><td>L</td><td></td><td>870</td><td>359</td></tr> <tr><td>W7</td><td>L+</td><td>L-</td><td>L+</td><td>860</td><td>353</td></tr> <tr><td>W6</td><td>L</td><td></td><td>L</td><td>770</td><td>297</td></tr> <tr><td>W5</td><td>L-</td><td>UL</td><td>L-</td><td>770</td><td>297</td></tr> <tr><td>W4</td><td>UL</td><td></td><td>UL</td><td>720</td><td>266</td></tr> <tr><td>W3</td><td>SUL</td><td></td><td>SUL</td><td>670</td><td>234</td></tr> <tr><td>W2</td><td></td><td>SUL</td><td></td><td>520</td><td>141</td></tr> <tr><td>W1</td><td></td><td></td><td></td><td>500</td><td>129</td></tr> </tbody> </table>	Fan speed level	COOL	HEAT	DRY	Fan speed (rpm)	Air flow rate (m3/h)	WF		UH		1300	620	WE		H		1300	620	WD	UH	M+	UH	1250	590	WC	H		H	1200	570	WB	M+	M	M+	1080	490	WA			M	1050	465	W9	M	L+		990	434	W8		L		870	359	W7	L+	L-	L+	860	353	W6	L		L	770	297	W5	L-	UL	L-	770	297	W4	UL		UL	720	266	W3	SUL		SUL	670	234	W2		SUL		520	141	W1				500	129	
Fan speed level	COOL	HEAT	DRY	Fan speed (rpm)	Air flow rate (m3/h)																																																																																													
WF		UH		1300	620																																																																																													
WE		H		1300	620																																																																																													
WD	UH	M+	UH	1250	590																																																																																													
WC	H		H	1200	570																																																																																													
WB	M+	M	M+	1080	490																																																																																													
WA			M	1050	465																																																																																													
W9	M	L+		990	434																																																																																													
W8		L		870	359																																																																																													
W7	L+	L-	L+	860	353																																																																																													
W6	L		L	770	297																																																																																													
W5	L-	UL	L-	770	297																																																																																													
W4	UL		UL	720	266																																																																																													
W3	SUL		SUL	670	234																																																																																													
W2		SUL		520	141																																																																																													
W1				500	129																																																																																													





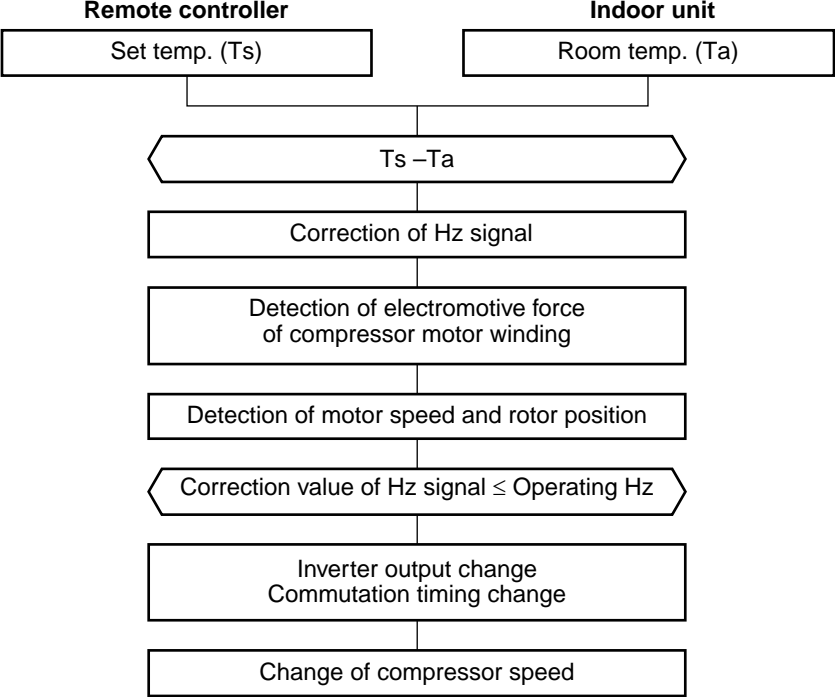
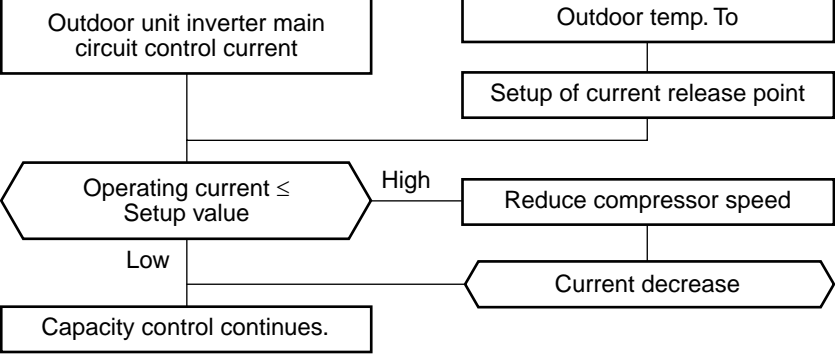

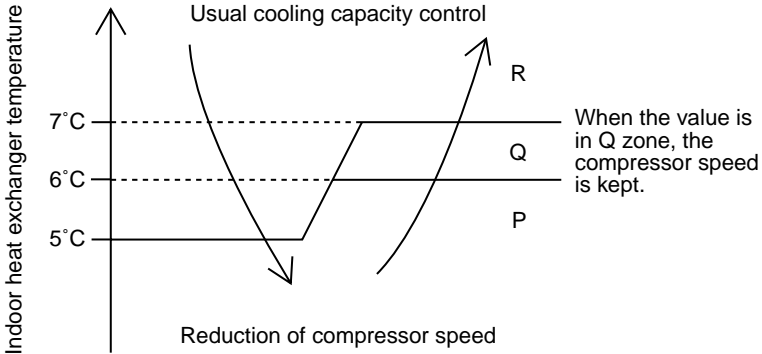
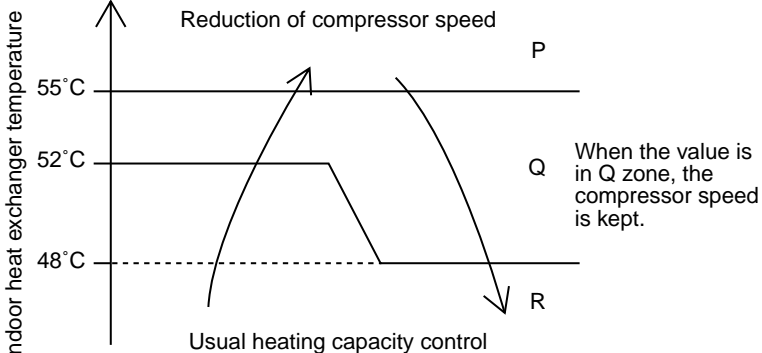

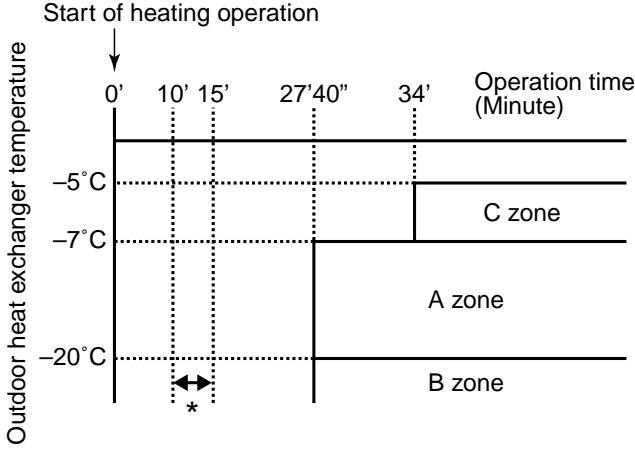

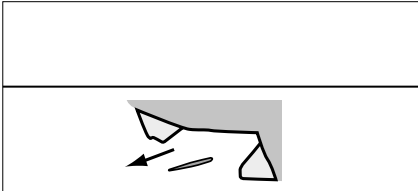
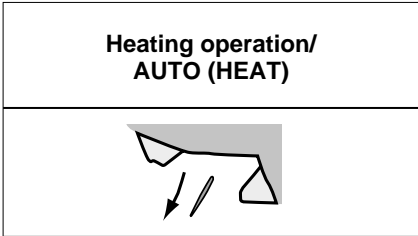

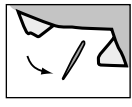
Item	Operation flow and applicable data, etc.	Description												
<p>2. Indoor fan motor control</p>	<p><In heating operation></p> <p>(Fig. 3)</p> <table border="1" data-bbox="491 504 981 728"> <thead> <tr> <th>Indication</th> <th>Fan speed</th> </tr> </thead> <tbody> <tr> <td>L </td> <td>W8</td> </tr> <tr> <td>L+ </td> <td>(L + M) / 2</td> </tr> <tr> <td>M </td> <td>WB</td> </tr> <tr> <td>M+ </td> <td>(M + H) / 2</td> </tr> <tr> <td>H </td> <td>WE</td> </tr> </tbody> </table> <p>(Fig. 4)</p> <p>* Fan speed = $(TC - (42 + a)) / 10 \times (WD - W8) + W8$ a : In up operation 1, in down operation 0</p>	Indication	Fan speed	L	W8	L+	(L + M) / 2	M	WB	M+	(M + H) / 2	H	WE	<ol style="list-style-type: none"> When setting the fan speed to L, L+, M, M+ or H on the remote controller, the operation is performed with the constant speed shown in Fig. 3 and Table 1. When setting the fan speed to AUTO on the remote controller, revolution of the fan motor is controlled to the fan speed level shown in Fig. 5 according to the set temperature and room temperature. Min air flow rate is controlled by temperature of the indoor heat exchanger (Tc) as shown in Fig. 4. Cold draft prevention, the fan speed is controlled by temperature of the indoor heat exchanger (Tc) as shown in Fig. 6. In order to prevent Cold draft when compressor step during heating operation. Then louver will move to upper position and fan speed will reduce or off. <p>Cold draft preventive control</p>
Indication	Fan speed													
L	W8													
L+	(L + M) / 2													
M	WB													
M+	(M + H) / 2													
H	WE													
<p>Basic fan control</p> <p>*1: Fan speed = $(M + -L+) \times 1 \div 4 + L+$ *2: Fan speed = $(M + -L+) \times 2 \div 4 + L+$ *3: Fan speed = $(M + -L+) \times 3 \div 4 + L+$ (Calculated with linear approximation from M+ and L+)</p> <p>(Fig. 5)</p>	<p>* No limitation while fan speed MANUAL mode is in stability. *A: When Tsc ≥ 24, A is 24, and when Tsc < 24, A is Tsc Tsc: Set value</p> <p>(Fig. 6)</p>													
<p>[In starting and in stability]</p> <table border="1" data-bbox="167 1863 1423 2049"> <thead> <tr> <th></th> <th>In starting</th> <th>In stability</th> </tr> </thead> <tbody> <tr> <td>FAN AUTO</td> <td> <ul style="list-style-type: none"> Until 12 minutes passed after operation start When 12 to 25 minutes passed after operation start and room temp. is 3°C or lower than set temp. </td> <td> <ul style="list-style-type: none"> When 12 to 25 minutes passed after operation start and room temp. is higher than (set temp. -3°C) When 25 minutes or more passed after operation start </td> </tr> <tr> <td>FAN Manual</td> <td> <ul style="list-style-type: none"> Room temp. < Set temp. -4°C </td> <td> <ul style="list-style-type: none"> Room temp. ≥ Set temp. -3.5°C </td> </tr> </tbody> </table>		In starting	In stability	FAN AUTO	<ul style="list-style-type: none"> Until 12 minutes passed after operation start When 12 to 25 minutes passed after operation start and room temp. is 3°C or lower than set temp. 	<ul style="list-style-type: none"> When 12 to 25 minutes passed after operation start and room temp. is higher than (set temp. -3°C) When 25 minutes or more passed after operation start 	FAN Manual	<ul style="list-style-type: none"> Room temp. < Set temp. -4°C 	<ul style="list-style-type: none"> Room temp. ≥ Set temp. -3.5°C 					
	In starting	In stability												
FAN AUTO	<ul style="list-style-type: none"> Until 12 minutes passed after operation start When 12 to 25 minutes passed after operation start and room temp. is 3°C or lower than set temp. 	<ul style="list-style-type: none"> When 12 to 25 minutes passed after operation start and room temp. is higher than (set temp. -3°C) When 25 minutes or more passed after operation start 												
FAN Manual	<ul style="list-style-type: none"> Room temp. < Set temp. -4°C 	<ul style="list-style-type: none"> Room temp. ≥ Set temp. -3.5°C 												

Item	Operation flow and applicable data, etc.	Description																																																																																																																																																								
<p>3. Outdoor fan motor control</p>	<p>The blowing air volume at the outdoor unit side is controlled. Receiving the operation command from the controller of indoor unit, the controller of outdoor unit controls fan speed.</p> <p>* For the fan motor, a DC motor with non-stage variable speed system is used. However, it is limited to 8 stages for reasons of controlling.</p>	<p>1) The operation command sent from the remote controller is processed by the indoor unit controller and transferred to the controller of the outdoor unit.</p> <p>2) When strong wind blows at outdoor side, the operation of air conditioner continues with the fan motor stopped.</p> <p>3) Whether the fan is locked or not is detected, and the operation of air conditioner stops and an alarm is displayed if the fan is locked.</p> <p>4) According to each operation mode, by the conditions of outdoor temperature (To) and compressor revolution, the speed of the outdoor fan shown in the table is selected.</p>																																																																																																																																																								
<p>4) Motor operates as shown in the table below.</p>																																																																																																																																																										
<table border="1" style="width: 100%; border-collapse: collapse;"> <thead> <tr> <th colspan="7" style="text-align: center;">In cooling operation</th> <th colspan="4" style="text-align: center;">In Heating operation</th> </tr> <tr> <th colspan="2" rowspan="2">Compressor speed (rps)</th> <th colspan="2">~ 13.8</th> <th colspan="2">~ 31.7</th> <th colspan="2">32.3 ~ MAX</th> <th colspan="2">Compressor speed (rps)</th> <th>~16.8</th> <th>~47.9</th> <th>48.5 ~ MAX</th> </tr> <tr> <th>MIN</th> <th>MAX</th> <th>MIN</th> <th>MAX</th> <th>MIN</th> <th>MAX</th> <th></th> <th></th> <th></th> </tr> </thead> <tbody> <tr> <td rowspan="6" style="text-align: center;">To</td> <td>To ≥ 38°C</td> <td>f 2</td> <td>f 3</td> <td>f C</td> <td>f D</td> <td>f E</td> <td>f F</td> <td rowspan="4" style="text-align: center;">To</td> <td>To ≥ 15°C</td> <td>f 3</td> <td>f 8</td> <td>f 9</td> </tr> <tr> <td>To ≥ 28°C</td> <td>f 2</td> <td>f 3</td> <td>f A</td> <td>f C</td> <td>f D</td> <td>f F</td> <td>To < 15°C</td> <td>f 3</td> <td>f 9</td> <td>f A</td> </tr> <tr> <td>To ≥ 15°C</td> <td>f 2</td> <td>f 3</td> <td>f 7</td> <td>f A</td> <td>f 9</td> <td>f C</td> <td>To < 5.5°C</td> <td>f 8</td> <td>f A</td> <td>f D</td> </tr> <tr> <td>To ≥ 5.5°C</td> <td>f 1</td> <td>f 3</td> <td>f 2</td> <td>f 5</td> <td>f 4</td> <td>f 7</td> <td>To < -5.0°C</td> <td>f B</td> <td>f C</td> <td>f D</td> </tr> <tr> <td>To ≥ 0°C</td> <td>f 1</td> <td>f 1</td> <td>f 1</td> <td>f 2</td> <td>f 2</td> <td>f 4</td> <td rowspan="3" style="text-align: center;">During ECO mode</td> <td>To ≥ 15°C</td> <td>f 3</td> <td>f 3</td> <td>f 6</td> </tr> <tr> <td>To < 0°C</td> <td>f 0</td> <td>f 0</td> <td>f 0</td> <td>f 1</td> <td>f 1</td> <td>f 2</td> <td>To < 15°C</td> <td>f 3</td> <td>f 3</td> <td>f 8</td> </tr> <tr> <td></td> <td></td> <td></td> <td></td> <td></td> <td></td> <td></td> <td>To < 5.5°C</td> <td>f 5</td> <td>f 9</td> <td>f 9</td> </tr> <tr> <td style="text-align: center;">During ECO mode</td> <td>To ≥ 38°C</td> <td>f 2</td> <td>f 3</td> <td>f B</td> <td>f C</td> <td>f C</td> <td>f D</td> <td colspan="2" style="text-align: center;">When To is abnormal</td> <td>f A</td> <td>f B</td> <td>f D</td> </tr> <tr> <td></td> <td>To < 38°C</td> <td>f 2</td> <td>f 3</td> <td>f 2</td> <td>f 3</td> <td>f B</td> <td>f C</td> <td colspan="5"></td> </tr> <tr> <td colspan="2" style="text-align: center;">When To is abnormal</td> <td>f D</td> <td>f F</td> <td>f D</td> <td>f F</td> <td>f D</td> <td>f F</td> <td colspan="5"></td> </tr> </tbody> </table>			In cooling operation							In Heating operation				Compressor speed (rps)		~ 13.8		~ 31.7		32.3 ~ MAX		Compressor speed (rps)		~16.8	~47.9	48.5 ~ MAX	MIN	MAX	MIN	MAX	MIN	MAX				To	To ≥ 38°C	f 2	f 3	f C	f D	f E	f F	To	To ≥ 15°C	f 3	f 8	f 9	To ≥ 28°C	f 2	f 3	f A	f C	f D	f F	To < 15°C	f 3	f 9	f A	To ≥ 15°C	f 2	f 3	f 7	f A	f 9	f C	To < 5.5°C	f 8	f A	f D	To ≥ 5.5°C	f 1	f 3	f 2	f 5	f 4	f 7	To < -5.0°C	f B	f C	f D	To ≥ 0°C	f 1	f 1	f 1	f 2	f 2	f 4	During ECO mode	To ≥ 15°C	f 3	f 3	f 6	To < 0°C	f 0	f 0	f 0	f 1	f 1	f 2	To < 15°C	f 3	f 3	f 8								To < 5.5°C	f 5	f 9	f 9	During ECO mode	To ≥ 38°C	f 2	f 3	f B	f C	f C	f D	When To is abnormal		f A	f B	f D		To < 38°C	f 2	f 3	f 2	f 3	f B	f C						When To is abnormal		f D	f F	f D	f F	f D	f F					
In cooling operation							In Heating operation																																																																																																																																																			
Compressor speed (rps)		~ 13.8		~ 31.7		32.3 ~ MAX		Compressor speed (rps)		~16.8	~47.9	48.5 ~ MAX																																																																																																																																														
		MIN	MAX	MIN	MAX	MIN	MAX																																																																																																																																																			
To	To ≥ 38°C	f 2	f 3	f C	f D	f E	f F	To	To ≥ 15°C	f 3	f 8	f 9																																																																																																																																														
	To ≥ 28°C	f 2	f 3	f A	f C	f D	f F		To < 15°C	f 3	f 9	f A																																																																																																																																														
	To ≥ 15°C	f 2	f 3	f 7	f A	f 9	f C		To < 5.5°C	f 8	f A	f D																																																																																																																																														
	To ≥ 5.5°C	f 1	f 3	f 2	f 5	f 4	f 7		To < -5.0°C	f B	f C	f D																																																																																																																																														
	To ≥ 0°C	f 1	f 1	f 1	f 2	f 2	f 4	During ECO mode	To ≥ 15°C	f 3	f 3	f 6																																																																																																																																														
	To < 0°C	f 0	f 0	f 0	f 1	f 1	f 2		To < 15°C	f 3	f 3	f 8																																																																																																																																														
							To < 5.5°C		f 5	f 9	f 9																																																																																																																																															
During ECO mode	To ≥ 38°C	f 2	f 3	f B	f C	f C	f D	When To is abnormal		f A	f B	f D																																																																																																																																														
	To < 38°C	f 2	f 3	f 2	f 3	f B	f C																																																																																																																																																			
When To is abnormal		f D	f F	f D	f F	f D	f F																																																																																																																																																			
<p>Outdoor fan speed (rpm)</p> <table border="1" style="display: inline-table; margin-right: 20px;"> <thead> <tr><th>Tab</th><th>Detail</th></tr> </thead> <tbody> <tr><td>f 0</td><td>0</td></tr> <tr><td>f 1</td><td>200</td></tr> <tr><td>f 2</td><td>300</td></tr> <tr><td>f 3</td><td>370</td></tr> <tr><td>f 4</td><td>440</td></tr> <tr><td>f 5</td><td>440</td></tr> <tr><td>f 6</td><td>500</td></tr> <tr><td>f 7</td><td>550</td></tr> </tbody> </table> <table border="1" style="display: inline-table;"> <thead> <tr><th>Tab</th><th>Detail</th></tr> </thead> <tbody> <tr><td>f 8</td><td>600</td></tr> <tr><td>f 9</td><td>650</td></tr> <tr><td>f A</td><td>700</td></tr> <tr><td>f B</td><td>700</td></tr> <tr><td>f C</td><td>800</td></tr> <tr><td>f D</td><td>800</td></tr> <tr><td>f E</td><td>800</td></tr> <tr><td>f F</td><td>800</td></tr> </tbody> </table>			Tab	Detail	f 0	0	f 1	200	f 2	300	f 3	370	f 4	440	f 5	440	f 6	500	f 7	550	Tab	Detail	f 8	600	f 9	650	f A	700	f B	700	f C	800	f D	800	f E	800	f F	800																																																																																																																				
Tab	Detail																																																																																																																																																									
f 0	0																																																																																																																																																									
f 1	200																																																																																																																																																									
f 2	300																																																																																																																																																									
f 3	370																																																																																																																																																									
f 4	440																																																																																																																																																									
f 5	440																																																																																																																																																									
f 6	500																																																																																																																																																									
f 7	550																																																																																																																																																									
Tab	Detail																																																																																																																																																									
f 8	600																																																																																																																																																									
f 9	650																																																																																																																																																									
f A	700																																																																																																																																																									
f B	700																																																																																																																																																									
f C	800																																																																																																																																																									
f D	800																																																																																																																																																									
f E	800																																																																																																																																																									
f F	800																																																																																																																																																									

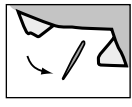
Item	Operation flow and applicable data, etc.	Description															
<p>4. Capacity control</p>	<p>The cooling or heating capacity depending on the load is adjusted.</p> <p>According to difference between the setup value of temperature and the room temperature, the capacity is adjusted by the compressor revolution.</p> 	<ol style="list-style-type: none"> 1) The difference between set temperature on remote controller (Ts) and room temperature (Ta) is calculated. 2) According to the temperature difference, the correction value of Hz signal which determines the compressor speed is set up. 3) The rotating position and speed of the motor are detected by the electromotive force occurred on the motor winding with operation of the compressor. 4) According to the difference resulted from comparison of the correction value of Hz signal with the present operation Hz, the inverter output and the commutation timing are varied. 5) Change the compressor motor speed by outputting power to the compressor. <p>* The contents of control operation are same in cooling operation and heating operation</p>															
<p>5. Current release control</p>	<p>This function prevents troubles on the electronic parts of the compressor driving inverter.</p> <p>This function also controls drive circuit of the compressor speed so that electric power of the compressor drive circuit does not exceed the specified value.</p>  <table border="1" data-bbox="188 1751 877 2042"> <thead> <tr> <th>Outdoor temp.</th> <th>Cooling current release value</th> <th>Heating current release value</th> </tr> </thead> <tbody> <tr> <td>45°C</td> <td>4.27A</td> <td rowspan="2">6.30A</td> </tr> <tr> <td>40°C</td> <td>4.88A</td> </tr> <tr> <td>16°C</td> <td>6.30A</td> <td rowspan="3">6.30A</td> </tr> <tr> <td>11°C</td> <td>15.5°C</td> </tr> <tr> <td></td> <td>10.5°C</td> </tr> </tbody> </table>	Outdoor temp.	Cooling current release value	Heating current release value	45°C	4.27A	6.30A	40°C	4.88A	16°C	6.30A	6.30A	11°C	15.5°C		10.5°C	<ol style="list-style-type: none"> 1) The input current of the outdoor unit is detected in the inverter section of the outdoor unit. 2) According to the detected outdoor temperature, the specified value of the current is selected. 3) Whether the current value exceeds the specified value or not is judged. 4) If the current value exceeds the specified value, this function reduces the compressor speed and controls speed up to the closest one commanded from the indoor unit within the range which does not exceed the specified value.
Outdoor temp.	Cooling current release value	Heating current release value															
45°C	4.27A	6.30A															
40°C	4.88A																
16°C	6.30A	6.30A															
11°C	15.5°C																
	10.5°C																

Item	Operation flow and applicable data, etc.	Description
<p>6. Release protective control by temperature of indoor heat exchanger</p>	<p><In cooling/dry operation> (Prevent-freezing control for indoor heat exchanger) In cooling/dry operation, the sensor of indoor heat exchanger detects evaporation temperature and controls the compressor speed so that temperature of the heat exchanger does not exceed the specified value.</p> 	<ol style="list-style-type: none"> 1) When temperature of the indoor heat exchanger drops below 5°C, the compressor speed is reduced. (P zone) 2) When temperature of the indoor heat exchanger rises in the range from 6°C to under 7°C, the compressor speed is kept. (Q zone) 3) When temperature of the indoor heat exchanger rises to 7°C or higher, the capacity control operation returns to the usual control in cooling operation. (R zone)
	<p><In heating operation> (Prevent-overpressure control for refrigerating cycle) In heating operation, the sensor of indoor heat exchanger detects condensation temperature and controls the compressor speed so that temperature of the heat exchanger does not exceed the specified value.</p> 	<ol style="list-style-type: none"> 1) When temperature of the indoor heat exchanger rises in the range from 52°C to 55°C, the compressor speed is kept. (Q zone) When temperature of the indoor heat exchanger drops in the range from 48°C to under 55°C, the compressor speed is kept. (Q zone) 2) When temperature of the indoor heat exchanger rises to 55°C or higher, the compressor speed is reduced. (P zone) 3) When temperature of the indoor heat exchanger does not rise to 52°C, or when it drops below to 48°C, the capacity control operation returns to the usual control in heating operation. (R zone)

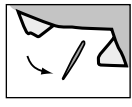
Item	Operation flow and applicable data, etc.	Description								
<p>7. Defrost control (Only in heating operation)</p>	<p>(This function removes frost adhered to the outdoor heat exchanger.)</p> <p>The temperature sensor of the outdoor heat exchanger (Te sensor) judges the frosting status of the outdoor heat exchanger and the defrost operation is performed with 4-way valve reverse defrost system.</p>  <p style="text-align: center;">* The minimum value of Te sensor 10 to 15 minutes after start of operation is stored in memory as Te0.</p> <p style="text-align: center;">Table 1</p> <table border="1" data-bbox="169 1043 936 1249"> <thead> <tr> <th>Zone</th> <th>Condition</th> </tr> </thead> <tbody> <tr> <td>A zone</td> <td>When $Te_0 - TE \geq 2.5$ continued for 2 minutes in A zone, defrost operation starts.</td> </tr> <tr> <td>B zone</td> <td>When the operation continued for 2 minutes in B zone, defrost operation starts.</td> </tr> <tr> <td>C zone</td> <td>When $Te_0 - TE \geq 3$ continued for 2 minutes in C zone, defrost operation starts.</td> </tr> </tbody> </table>	Zone	Condition	A zone	When $Te_0 - TE \geq 2.5$ continued for 2 minutes in A zone, defrost operation starts.	B zone	When the operation continued for 2 minutes in B zone, defrost operation starts.	C zone	When $Te_0 - TE \geq 3$ continued for 2 minutes in C zone, defrost operation starts.	<p>The necessity of defrost operation is detected by the outdoor heat exchanger temperature. The conditions to detect the necessity of defrost operation differ in A, B, or C zone each. (Table 1)</p> <p><Defrost operation></p> <ul style="list-style-type: none"> Defrost operation in A to C zones <ol style="list-style-type: none"> 1) Stop operation of the compressor for 20 seconds. 2) Invert (ON) 4-way valve 10 seconds after stop of the compressor. 3) The outdoor fan stops at the same time when the compressor stops. 4) When temperature of the indoor heat exchanger becomes 38°C or lower, stop the indoor fan. <p><Finish of defrost operation></p> <ul style="list-style-type: none"> Returning conditions from defrost operation to heating operation <ol style="list-style-type: none"> 1) Temperature of outdoor heat exchanger rises to +8°C or higher. 2) Temperature of outdoor heat exchanger is kept at +5°C or higher for 80 seconds. 3) Defrost operation continues for 15 minutes. <p><Returning from defrost operation></p> <ol style="list-style-type: none"> 1) Stop operation of the compressor for approx. 50 seconds. 2) Invert (OFF) 4-way valve approx. 40 seconds after stop of the compressor. 3) The outdoor fan starts rotating at the same time when the compressor starts.
Zone	Condition									
A zone	When $Te_0 - TE \geq 2.5$ continued for 2 minutes in A zone, defrost operation starts.									
B zone	When the operation continued for 2 minutes in B zone, defrost operation starts.									
C zone	When $Te_0 - TE \geq 3$ continued for 2 minutes in C zone, defrost operation starts.									

Item	Operation flow and applicable data, etc.	Description										
<p>8. Louver control</p> <p>1) Louver position</p> <p>2) Air direction adjustment</p> <p>3) Swing</p>	<p>This function controls the air direction of the indoor unit.</p> <ul style="list-style-type: none"> The position is automatically controlled according to the operation mode (COOL/HEAT). The set louver position is stored in memory by the microcomputer, and the louver returns to the stored position when the next operation is performed. (Cooling/Heating memory position) <p>The angle of the louver is indicated as the louver closes fully is 0°.</p> <p>1) Louver position in cooling operation</p> <div data-bbox="438 544 858 801" style="border: 1px solid black; padding: 5px;">  <p>Initial setting of "Cooling storage position" Louver : Directs downward (35.3°)</p> </div> <p>2) Louver position in heating operation</p> <div data-bbox="443 916 863 1223" style="border: 1px solid black; padding: 5px;"> <p style="text-align: center;">Heating operation/ AUTO (HEAT)</p>  <p>Initial setting of "Heating storage position" Louver : Directs downward (80.5°)</p> </div> <div data-bbox="177 1312 1120 1585" style="border: 1px solid black; padding: 5px; text-align: center;"> <p>Air direction</p> <table border="1" style="width: 100%; text-align: center;"> <tr> <td>Horizontal blowing</td> <td>Inclined blowing</td> <td>Blowing downward</td> <td>Inclined blowing</td> <td>Horizontal blowing</td> </tr> <tr> <td></td> <td></td> <td></td> <td></td> <td></td> </tr> </table> </div>	Horizontal blowing	Inclined blowing	Blowing downward	Inclined blowing	Horizontal blowing						<p>• The louver position can be arbitrarily set up by pressing [FIX] button.</p> <p>• Swing When pressing [SWING] button during operation, the louver starts swinging.</p>
Horizontal blowing	Inclined blowing	Blowing downward	Inclined blowing	Horizontal blowing								
												

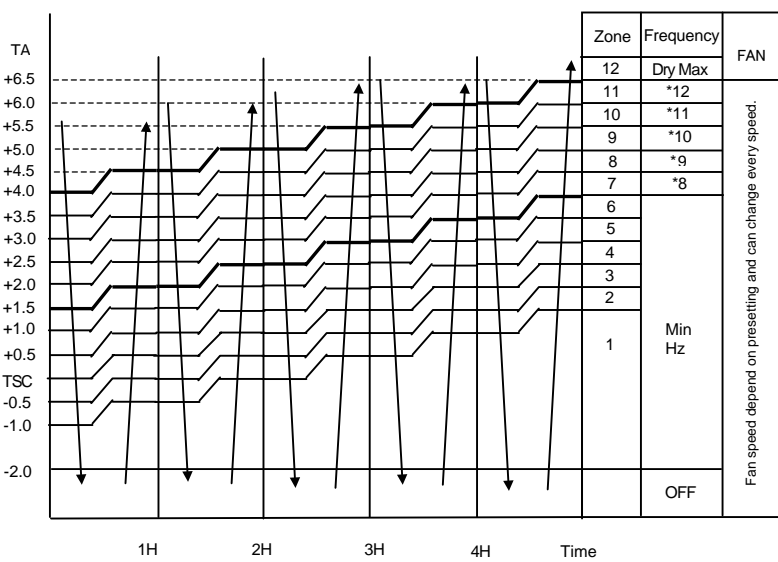
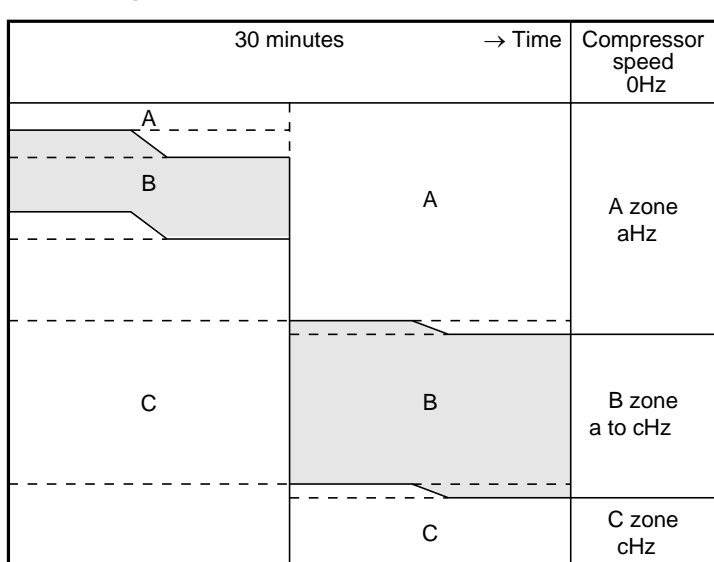
Item	Operation flow and applicable data, etc.	Description																																										
<p>9. ECO operation</p>	<p>When pressing [ECO] button on the remote controller, a Economic operation is performed.</p> <p><Cooling operation></p> <p>This function operates the air conditioner with the difference between the set and the room temperature as shown in the following figure.</p>  <table border="1" data-bbox="798 448 1005 963"> <thead> <tr> <th>Zone</th> <th>Frequency</th> <th>FAN</th> </tr> </thead> <tbody> <tr><td>12</td><td>Dry Max</td><td></td></tr> <tr><td>11</td><td>*12</td><td></td></tr> <tr><td>10</td><td>*11</td><td></td></tr> <tr><td>9</td><td>*10</td><td></td></tr> <tr><td>8</td><td>*9</td><td></td></tr> <tr><td>7</td><td>*8</td><td></td></tr> <tr><td>6</td><td></td><td></td></tr> <tr><td>5</td><td></td><td></td></tr> <tr><td>4</td><td></td><td></td></tr> <tr><td>3</td><td></td><td></td></tr> <tr><td>2</td><td></td><td></td></tr> <tr><td>1</td><td>Min Hz</td><td></td></tr> <tr><td></td><td></td><td>OFF</td></tr> </tbody> </table> <p style="text-align: right; font-size: small;">Fan speed depend on presetting and can change every speed.</p>	Zone	Frequency	FAN	12	Dry Max		11	*12		10	*11		9	*10		8	*9		7	*8		6			5			4			3			2			1	Min Hz				OFF	<p><Cooling operation></p> <ol style="list-style-type: none"> 1) The control target temperature increase 0.5°C per hour up to 2°C starting from the set temperature when ECONO has been received. 2) The indoor fan speed is depend on presetting and can change every speed after setting ECO operation. 3) The compressor speed is controlled as shown in the left figure.
Zone	Frequency	FAN																																										
12	Dry Max																																											
11	*12																																											
10	*11																																											
9	*10																																											
8	*9																																											
7	*8																																											
6																																												
5																																												
4																																												
3																																												
2																																												
1	Min Hz																																											
		OFF																																										
	<p>* 12 (DRY max - COOL min) /6 x 5 + COOL min * 11 (DRY max - COOL min) /6 x 4 + COOL min * 10 (DRY max - COOL min) /6 x 3 + COOL min * 9 (DRY max - COOL min) /6 x 2 + COOL min * 8 (DRY max - COOL min) /6 x 1 + COOL min</p> <table border="1" data-bbox="670 1187 893 1321"> <thead> <tr> <th colspan="2">Hz</th> </tr> </thead> <tbody> <tr> <td>Cool min</td> <td>20</td> </tr> <tr> <td>DRY max</td> <td>37</td> </tr> </tbody> </table>	Hz		Cool min	20	DRY max	37																																					
Hz																																												
Cool min	20																																											
DRY max	37																																											
	<p><Heating operation></p>  <table border="1" data-bbox="861 1366 1005 1926"> <thead> <tr> <th>Compressor speed</th> <th>0Hz</th> </tr> </thead> <tbody> <tr> <td>A zone</td> <td>aHz</td> </tr> <tr> <td>B zone</td> <td>a to cHz</td> </tr> <tr> <td>C zone</td> <td>cHz</td> </tr> </tbody> </table> <table border="1" data-bbox="670 1926 893 2060"> <thead> <tr> <th colspan="2">Hz</th> </tr> </thead> <tbody> <tr> <td>a</td> <td>20</td> </tr> <tr> <td>c</td> <td>50</td> </tr> </tbody> </table>	Compressor speed	0Hz	A zone	aHz	B zone	a to cHz	C zone	cHz	Hz		a	20	c	50	<p><Heating operation></p> <ol style="list-style-type: none"> 1) Setting the compressor speed to Max. aHz, the temperature zone in which the operation can be performed with Max. cHz is gradually widened after 30 minutes passed when starting ECO operation. 2) The indoor fan speed is depend on presetting and can change every speed after setting ECO operation. 																												
Compressor speed	0Hz																																											
A zone	aHz																																											
B zone	a to cHz																																											
C zone	cHz																																											
Hz																																												
a	20																																											
c	50																																											

Item	Operation flow and applicable data, etc.	Description													
<p>10. Temporary operation</p>	<p>Pressing [RESET] button starts the temporary operation of [AUTO] operation. When keeping [RESET] button pressed for 10 seconds or more, the temporary [COOL] operation is performed.</p> <pre> graph TD A[Filter lamp ON] -- YES --> B[Press RESET button.] A -- NO --> C{Did you press [RESET] button for 3 seconds or more?} C -- NO --> D[Temporary [AUTO] operation] C -- YES --> E{Did you press [RESET] button for 10 seconds or more?} E -- NO --> F[Switch to [AUTO RESTART] control.] E -- YES --> G[Temporary [COOL] Operation] G --> A </pre>	<ol style="list-style-type: none"> 1) When pressing [RESET] button, the temporary [AUTO] operation starts. 2) When keeping [RESET] button pressed for 3 seconds or more, Pi, Pi, Pi sound is heard and [AUTO RESTART] control is changed. 3) When keeping [RESET] button pressed for 10 seconds or more, "Pi" sound is heard and the temporary [COOL] operation starts. 4) If the filter lamp goes on, press [RESET] button to go off the filter lamp, and then press [RESET] button again. 5) To stop the temporary operation, press the button again. 													
<p>11. Discharge temperature control</p> <table border="1" data-bbox="164 846 922 1182"> <thead> <tr> <th data-bbox="164 846 316 891">Td value</th> <th data-bbox="316 846 922 891">Control operation</th> </tr> </thead> <tbody> <tr> <td data-bbox="164 891 316 936">117°C</td> <td data-bbox="316 891 922 936">Judges as an error and stops the compressor.</td> </tr> <tr> <td data-bbox="164 936 316 981">112°C</td> <td data-bbox="316 936 922 981">Reduce the compressor speed.</td> </tr> <tr> <td data-bbox="164 981 316 1025">108°C</td> <td data-bbox="316 981 922 1025">Reduce slowly compressor speed.</td> </tr> <tr> <td data-bbox="164 1025 316 1070">105°C</td> <td data-bbox="316 1025 922 1070">Keeps the compressor speed.</td> </tr> <tr> <td data-bbox="164 1070 316 1137">98°C</td> <td data-bbox="316 1070 922 1137">If the operation is performed with lower speed than one commanded by the serial signal, speed is slowly raised up to the commanded speed.</td> </tr> <tr> <td data-bbox="164 1137 316 1182">98°C</td> <td data-bbox="316 1137 922 1182">Operates with speed commanded by the serial signal.</td> </tr> </tbody> </table>	Td value	Control operation	117°C	Judges as an error and stops the compressor.	112°C	Reduce the compressor speed.	108°C	Reduce slowly compressor speed.	105°C	Keeps the compressor speed.	98°C	If the operation is performed with lower speed than one commanded by the serial signal, speed is slowly raised up to the commanded speed.	98°C	Operates with speed commanded by the serial signal.	<ol style="list-style-type: none"> 1. Purpose This function detects error on the refrigerating cycle or error on the compressor, and performs protective control. 2. Operation <ul style="list-style-type: none"> • Control of the compressor speed The speed control is performed as described in the left table based upon the discharge temperature.
Td value	Control operation														
117°C	Judges as an error and stops the compressor.														
112°C	Reduce the compressor speed.														
108°C	Reduce slowly compressor speed.														
105°C	Keeps the compressor speed.														
98°C	If the operation is performed with lower speed than one commanded by the serial signal, speed is slowly raised up to the commanded speed.														
98°C	Operates with speed commanded by the serial signal.														

Item	Operation flow and applicable data, etc.	Description
<p>12. Pulse Modulating valve (P.M.V.) control</p>	<p>This function controls throttle amount of the refrigerant in the refrigerating cycle. According to operating status of the air conditioner, this function also controls the open degree of valve with an expansion valve with pulse Modulation.</p> <pre> graph TD Start[Starting up] --> Init[Initialize] Init --> Move[Move to initial position] Move --> Comp[Compressor ON] Comp --> SH[SH control] Comp --> Td[Td release control] SH --> PMV[PMV open degree control] Td --> PMV PMV --> Stop[Stop by remote controller] PMV --> Room[Room temp. sensor (Ta sensor) control] Stop --> Power[Power OFF] Room --> Defrost[Defrost] Defrost --> Move </pre> <p>* SH (Super Heat amount) = Ts (Temperature of suction pipe of the compressor) – Tc or Te (Heat exchanger temperature at evaporation side)</p> <p>* PMV: Pulse Modulating Valve</p>	<ol style="list-style-type: none"> 1) When starting the operation, move the valve once until it fits to the stopper. (Initialize) * In this time, "Click" sound may be heard. 2) Adjust the open degree of valve by super heat amount. (SH control) 3) If the discharge temperature was excessively up, adjust the open degree of valve so that it is in the range of set temperature. (Discharge temp. control) 4) When defrost operation is performed, the open degree of valve is adjusted according to each setup conditions during preparation for defrost and during defrost operation (4-way valve is inverted.). 5) To turn off the compressor while the air conditioner stops by control of the thermostat or by remote controller, adjust the open degree of valve to the setup value before stop of the compressor.

Item	Operation flow and applicable data, etc.	Description													
<p>13. Self-Cleaning function</p>	<div style="text-align: center;"> <pre> graph TD A[Unit now performing cooling or dry operation] --> B[Press "STOP" button] B --> C[Only timer indicator lights, and Self Cleaning operation starts] C --> D[Time set now elapses] D --> E[Operation stops] </pre> </div> <ul style="list-style-type: none"> • During Self-Cleaning operations: The louver opens slightly. The indoor fan operates continuously at a speed of 500 rpm. <p>Self-Cleaning operation times</p> <table border="1" data-bbox="395 1227 1262 1576"> <thead> <tr> <th></th> <th>Operation time</th> <th>Self-Cleaning operation time</th> </tr> </thead> <tbody> <tr> <td rowspan="2">Cooling: Auto (cooling) Dry</td> <td>Up to 10 minutes</td> <td>No Self-Cleaning operation performed (0 minutes)</td> </tr> <tr> <td>10 minutes or longer</td> <td>30 mins.</td> </tr> <tr> <td>Heating: Auto (heating)</td> <td colspan="2" rowspan="3">No Self-Cleaning operation performed</td> </tr> <tr> <td>Auto (fan only)</td> </tr> <tr> <td>Shutdown</td> </tr> </tbody> </table> <ul style="list-style-type: none"> • To stop an ongoing Self-Cleaning operation at any time Press the start/stop button on the remote controller twice during the Self-Cleaning operation. (After pressing the button for the first time, press it for the second time without delay (within 10 minutes).) 		Operation time	Self-Cleaning operation time	Cooling: Auto (cooling) Dry	Up to 10 minutes	No Self-Cleaning operation performed (0 minutes)	10 minutes or longer	30 mins.	Heating: Auto (heating)	No Self-Cleaning operation performed		Auto (fan only)	Shutdown	<p>1. Purpose</p> <p>The Self-Cleaning operation is to minimize the growth of mold, bacteria etc. by running the fan and drying so as to keep the inside of the air conditioner clean.</p> <p>Self-Cleaning operation</p> <p>When the cooling or dry operation shuts down, the unit automatically starts the Self-Cleaning operation which is then performed for the specified period based on duration of the operation which was performed prior to the shutdown, after which the Self-Cleaning operation stops. (The Self-Cleaning operation is not performed after a heating operation.)</p> <p>2. Operation</p> <ol style="list-style-type: none"> 1) When the stop signal from the remote controller or timer-off function is received, only the timer indicator light. 2) The period of the Self-Cleaning operation is determined by the duration of the operation performed prior to the reception of the stop code. 3) After the Self-Cleaning operation has been performed for the specified period, the unit stops operating.
	Operation time	Self-Cleaning operation time													
Cooling: Auto (cooling) Dry	Up to 10 minutes	No Self-Cleaning operation performed (0 minutes)													
	10 minutes or longer	30 mins.													
Heating: Auto (heating)	No Self-Cleaning operation performed														
Auto (fan only)															
Shutdown															

Item	Operation flow and applicable data, etc.		Description
13. Self-Cleaning function	<ul style="list-style-type: none"> Self-Cleaning diagram 		
Operation display	ON	OFF	OFF
FCU fan	ON rpm is depend on presetting.	ON (500RPM)	OFF
FCU louver	OPEN	OPEN (12.7°)	CLOSE
Timer display	ON or OFF depend on presetting of timer function.	ON	ON or OFF depend on presetting of timer function.
Compressor	ON or OFF depend on presetting per room temperature.	OFF	OFF
CDU fan	ON or OFF depend on presetting per room temperature.	OFF	OFF

← Cool mode or dry mode operation more than 10 mins. →

← Self-Cleaning mode operate 30 mins. →

Operation time →

Turn off by remote controller or timer-off function. Automatically turn-off.

**How to Set or Cancel Self-Cleaning operation.
(Default setting from factory is ON)**

- Connect jumper lead at J201 of the indoor P.C. board assembly.
- To cancel Self-Cleaning operation.

Turn the power supply ON

↓

Press the [RESET] button located on the front panel of the indoor unit for more than 3 seconds.

↓

After 3 seconds, the unit beeps three times.
The Self-Cleaning is cancelled.
- To set Self-Cleaning operation.

Turn the power supply ON

↓

Press the [RESET] button located on the front panel of the indoor unit for more than 3 seconds.

↓

After 3 seconds, the unit beeps three times
and the **indicator blinks for 5 seconds.**
The Self-Cleaning is set.

One J201 is added, it will effect as following.

- The operation when press the RESET button for 3 seconds will be changed from Set/Cancel the AUTO-RESTART to Set/Cancel the Self-Cleaning.
- AUTO-RESTART function will not activate. In case of AUTO-RESTART is need, disconnect the jumper J201 and set it again after Set/Cancel the Self-Cleaning finished.

Note :
J201 is near the MCU, so so take steps to ensure that it will not be exposed to excessive of heat. Also take care to avoid solder bridging with the surrounding components.

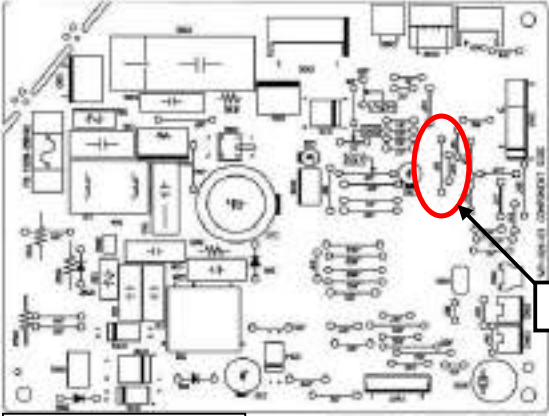
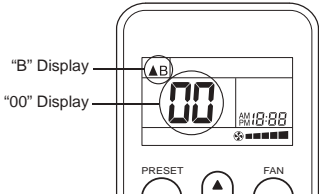
Item	Operation flow and applicable data, etc.	Description
	 <p>PCB NO : WP-020</p>	
<p>14. Remote-A or B selection</p>	<p>Setting the remote controller To separate using of remote control for each indoor unit in case of 2 air conditioner are installed nearby.</p> <p>Remote Control B Setup.</p> <ol style="list-style-type: none"> 1) Press RESET button on the indoor unit to turn the air conditioner ON. 2) Point the remote control at the indoor unit. 3) Push and hold CHK ● button on the Remote Control by the tip of the pencil. "00" will be shown on the display. 4) Press MODE ● during pushing CHK ●. "B" will show on the display and "00" will disappear and the air conditioner will turn OFF. The Remote Control B is memorized. <p>Note : 1. Repeat above step to reset Remote Control to be A. 2. Remote Control A has not "A" display. 3. Default setting of Remote Control from factory is A.</p> 	<ol style="list-style-type: none"> 1. Purpose This operation is to operate only one indoor unit using one remote controller. 2. Description When operating one indoor unit in a situation where two indoor units have been installed in the same room or nearby rooms, this operation prevents the remote controller signal from being received simultaneously by both units, thus preventing both units from operating. 3. Operation The indoor unit on which the remote controller selection has been set to B receives the signal of the remote controller also set to B. (At the factory the remote controller selection is set to A on all the indoor units. There is no A setting display.)

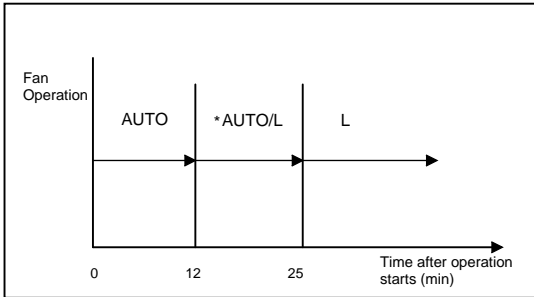
Item	Operation flow and applicable data, etc.	Description
<p>15. QUIET mode</p>	<p>When the [QUIET] button is pressed, the fan of the indoor unit will be restricted the revolving speed at speed L – until the [QUIET] button is pressed once again (cancel Quiet mode).</p>	<p>Quiet mode is the system which, control the revolving speed of indoor fan to work constantly at lower than speed L. In addition, noise level of indoor unit is less than usual.</p> <p>Remarks :</p> <ol style="list-style-type: none"> 1. Quiet mode is unable to work in dry mode. 2. Quiet mode is appropriate to work with less cooling load and less heating load condition. Because of the fan speed L- may cause not enough the cooling capacity or heating capacity.
<p>16. COMFORT SLEEP mode</p>	<p>Cooling mode</p> <ul style="list-style-type: none"> • The preset temperature will increase as show on ECO operation (Item No. 9) • Press the [COMFORT SLEEP] button to choose the operating hours. Repeat pressing to select the hours. (1hr, 3hr, 5hr or 9hr) • If the [COMFORT SLEEP] button is pressed again means cancel comfort sleep mode. <p>Heating mode</p> <ul style="list-style-type: none"> • The preset temperature will drop down as show on ECO operation (Item No. 9) • Press the [COMFORT SLEEP] button to choose the operating hours. Repeat pressing to select the hours. (1hr, 3hr, 5hr or 9 hr) • If the [COMFORT SLEEP] button is pressed again means cancel comfort sleep mode. 	<p>The principles of comfort sleep mode are:</p> <ul style="list-style-type: none"> • Quietness for more comfortable. When room temperature reach setting temperature • Save energy by changing room temperature automatically. • The air condition can shut down by itself automatically. <p>Remarks:</p> <ol style="list-style-type: none"> 1. Comfort sleep mode will not operate in dry mode and fan only mode.
<p>17. One-Touch Comfort</p>	<p>One touch comfort is the fully automated operation that is set according to the preferable condition in a region.</p>  <p>*AUTO/L: Fan operates depends on the setting temperature and room temperature.</p> <p>During the One Touch Comfort mode if the indoor unit receives any signal with other operation mode, the unit will cancel the comfort mode and operates according to the signal received.</p>	<p>Operation condition for model to Europe market</p> <p>When an indoor unit receives "One Touch Comfort Signal" from the remote controller, the indoor unit operates as following.</p> <ol style="list-style-type: none"> 1) Air conditioner starts to operation when the signal is received, even if the air conditioner was OFF. 2) Operation mode is set according to room temperature, the same as AUTO mode. 3) Target temperature is 24°C. 4) Louver position is set as stored position of the operating mode. 5) Fan is controlled as followings.

Item	Operation flow and applicable data, etc.	Description
18. Hi-POWER Mode	<p>([Hi-POWER] button on the remote controller is pressed)</p> <p>When [Hi-POWER] button is pressed while the indoor unit is in Auto, Cooling or Heating operation, Hi-POWER mark is indicated on the display of the remote controller and the unit operates as follows.</p> <ol style="list-style-type: none"> 1. Automatic operation <ul style="list-style-type: none"> • The indoor unit operates in according to the current operation. 2. Cooling operation <ul style="list-style-type: none"> • The preset temperature drops 1°C (The value of the preset temperature on the remote controller does not change.) The indoor unit's fan speed level increase 1 tap 3. Heating operation <ul style="list-style-type: none"> • The preset temperature increases 2°C (The value of the preset temperature on the remote controller does not change.) The indoor unit's fan speed level increase 1 tap 4. The Hi-POWER mode can not be set in Dry operation 	
19. FILTER Indicator	<p>When the elapsed time reaches 1000 hours after air conditioner operation, the FILTER indicator lights. After cleaning the filters, turn off the FILTER indicator.</p> <p>How to Turn Off FILTER Indicator Press [RESET] button on the indoor unit.</p> <p>NOTE : If [RESET] button is pushed while the FILTER indicator is not lit, the indoor unit will start the automatic operation.</p>	

9-3. Auto Restart Function

This indoor unit is equipped with an automatic restarting function which allows the unit to restart operating with the set operating conditions in the event of a power supply being accidentally shut down.

The operation will resume without warning three minutes after power is restored.

This function is not set to work when shipped from the factory. Therefore it is necessary to set it to work.

9-3-1. How to Set the Auto Restart Function

To set the auto restart function, proceed as follows:

The power supply to the unit must be on ; the function will not set if the power is off.

Press the [RESET] button located in the center of the front panel continuously for three seconds.

The unit receives the signal and beeps three times.

The unit then restarts operating automatically in the event of power supply being accidentally shut down.

• When the unit is standby (Not operating)

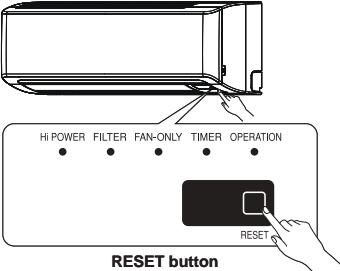
Operation	Motions
<p>Press [RESET] button for more than three seconds. (Less than 10 seconds)</p> 	<p>The unit is on standby.</p> <p style="text-align: center;">↓</p> <p>The unit starts to operate. The green indicator is on.</p> <p style="text-align: center;">↓ After approx. three seconds,</p> <p>The unit beeps three times and continues to operate. The green indicator flashes for 5 seconds.</p> <p>If the unit is not required to operate at this time, press [RESET] button once more or use the remote controller to turn it off.</p>

• When the unit is in operation

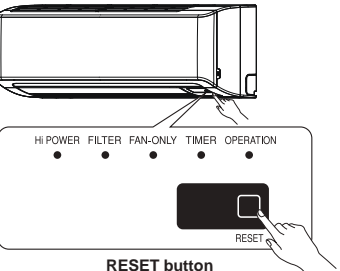
Operation	Motions
<p>Press [RESET] button for more than three seconds. (Less than 10 seconds)</p> 	<p>The unit is in operation. The green indicator is on.</p> <p style="text-align: center;">↓</p> <p>The unit stops operating. The green indicator is turned off.</p> <p style="text-align: center;">↓ After approx. three seconds,</p> <p>The unit beeps three times. The green indicator flashes for 5 seconds.</p> <p>If the unit is required to operate at this time, press [RESET] button once more or use the remote controller to turn it on.</p>

• While the filter check indicator is on, the RESET button has the function of filter reset button.

9-3-2. How to Cancel the Auto Restart Function

To cancel auto restart function, proceed as follows :

Repeat the setting procedure : the unit receives the signal and beeps three times.

The unit will be required to be turned on with the remote controller after the main power supply is turned off.

• **When the system is on stand-by (not operating)**

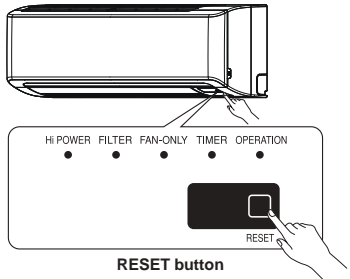
Operation	Motions
<p>Press [RESET] button for more than three seconds. (Less than 10 seconds)</p> 	<p>The unit is on standby.</p> <p style="text-align: center;">↓</p> <p>The unit starts to operate. The green indicator is on.</p> <p style="text-align: center;">↓ After approx. three seconds,</p> <p>The unit beeps three times and continues to operate.</p> <p>If the unit is not required to operate at this time, press [RESET] button once more or use the remote controller to turn it off.</p>

• **When the system is operating**

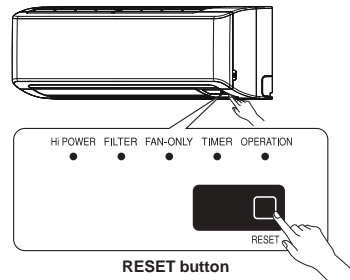
Operation	Motions
<p>Press [RESET] button for more than three seconds. (Less than 10 seconds)</p> 	<p>The unit is in operation. The green indicator is on.</p> <p style="text-align: center;">↓</p> <p>The unit stops operating. The green indicator is turned off.</p> <p style="text-align: center;">↓ After approx. three seconds,</p> <p>The unit beeps three times.</p> <p>If the unit is required to operate at this time, press [RESET] button once more or use the remote controller to turn it on.</p>

9-3-3. Power Failure During Timer Operation

When the unit is turned off because of power failure during timer operation, the timer operation is cancelled. In that case, set the timer operation again.

NOTE :

The Everyday Timer is reset while a command signal can be received from the remote controller even if it stopped due to a power failure.

9-4. Remote control

9-4-1. Function of Push Button

- ① Infrared signal emitter
- ② Start/Stop button
- ③ Mode select button (MODE)
- ④ Temperature button (TEMP)
- ⑤ Fan speed button (FAN)
- ⑥ Swing louver button (SWING)
- ⑦ Set louver button (FIX)
- ⑧ On timer button (ON)
- ⑨ Off timer button (OFF)
- ⑩ Setup button (SET)
- ⑪ Clear button (CLR)
- ⑫ Memory and Preset button (PRESET)
- ⑬ One-Touch button (ONE-TOUCH)
- ⑭ High power button (Hi-POWER)
- ⑮ Economy button (ECO)
- ⑯ Quiet button (QUIET)
- ⑰ Comfort sleep button (COMFORT SLEEP)
- ⑱ Filter reset button (FILTER)
- ⑲ Set clock button (CLOCK)
- ⑳ Check button (CHECK)
- ㉑ Reset button (RESET)

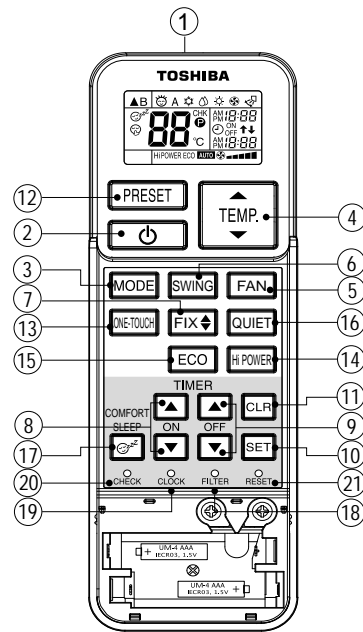

Note:

- The provided Remote Controller is a wireless type, which also can be used as a wire. Please see "How to Connect The Remote Controller for Wired Operation", located in installation instruction, in case of wired control is required.
- In wire operation, remote controller will return to initial condition (PRESET, TIMER and CLOCK will return to initial condition) when user shutdown power supply of Air conditioner.

9-4-2. Operation of remote control

1. ONE-TOUCH

Press the "ONE-TOUCH" button for fully automated operation that is customised to the typical consumer preferences in your region of the world. The customised settings control temperature air flow strength, air flow direction and other settings to provide you alternate contact with "ONE-TOUCH" OF THE BUTTON. If you prefer other settings you can select from the many other operation functions of your Toshiba unit

Press ● ONE-TOUCH : Start the operation.

2. AUTOMATIC OPERATION

To automatically select cooling, heating, or fan only operation.

1. Press ● MODE : Select A.
2. Press ⬇️ MODE : Select A.



3. COOLING / HEATING / FAN ONLY OPERATION

To automatically select cooling, heating, or fan only operation.

1. Press ● MODE : Select Cool ☀️, Heat ☀️, or Fan only 🌀.
2. Press ⬇️ MODE : Set the desired temperature.
Cooling: Min. 17°C, Heating : Max, 30°C, Fan Only: No temperature indication
3. Press ● FAN : Select AUTO, LOW 📉, LOW+ 📈, MED 📊, MED+ 📈📈, or HIGH 📈📈📈.

4. DRY OPERATION (COOLING ONLY)

For dehumidification, a moderate cooling performance is controlled automatically.

1. Press  MODE : Select Dry ☼ .
2. Press  MODE : Set the desired temperature.

5. HI-POWER OPERATION

To automatically control room temperature and airflow for faster cooling or heating operation (except in DRY and FAN ONLY mode)

Press  HI-POWER : Start and stop the operation.

6. ECO OPERATION

To automatically control room to save energy (except in DRY and FAN ONLY mode)

Press  ECO : Start and stop the operation.

Note: Cooling operation; the set temperature will increase automatically 0.5 degree/ hour for 4 hours (maximum 2 degrees increase). For heating operation the set temperature will decrease.







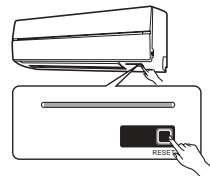

7. TEMPORARY OPERATION

In case of the misplaced or discharged remote control

- Pressing the RESET button, the unit can start or stop without using the remote control.
- Operation mode is set on AUTOMATIC operation, preset temperature is 24°C and fan operation is automatic speed.









8. TIMER OPERATION

Setting the ON Timer		Setting the OFF Timer	
1	Press  ON  : Set the desired ON timer.	Press  OFF  : Set the desired OFF timer.	
2	Press  : Set the timer	Press  : Set the timer.	
3	Press  : Cancel the timer	Press 	

Everyday timer allows the user to set both the ON & OFF timers and will be activated on a daily basis.

Setting Everyday Timer

1	Press  ON  : Set the ON timer .	3	Press  .
2	Press  OFF  : Set the OFF timer .	4	Press  button during the (↑ or ↓) mark flashing.

- During the every day timer is activation, both arrows (↑ or ↓) are indicated.

Note:

- Keep the remote control in accessible transmission to the indoor unit; otherwise, the time lag of up to 15 minutes will occur.
- The setting will be saved for the next same operation.

9. PRESET OPERATION

Set your preferred operation for future use. The setting will be memorized by the unit for future operation (except air flow direction).

1. Select your preferred operation.
2. Press and hold ● PRESET for 3 seconds to memorize the setting. The ● mark displays.
3. Press ● PRESET : Operate the preset operation.

10. AUTO RESTART OPERATION

To automatically restart the conditioner after the power failure (Power of the unit must be on.)

Setting

1. Press and hold the RESET button on the indoor unit for 3 seconds to set the operation. (3 beep sound and OPERATION lamp blink 5 time/sec for 5 secprms)
 - Do not operate ON timer and OFF timer.
2. Press and hold the RESET button on the indoor unit for 3 seconds to cancel the operation. (3 beep sound but OPERATION lamp does not blink)

11. QUIET OPERATION

To operate at super low fan speed for quiet operation (except in DRY mode)

Press ● QUIET : Start and stop the operation.

Note: Under certain conditions, QUIET operation may not provide adequate cooling or heating due to low sound features.

12. COMFORT SLEEP OPERATION

To save energy while sleeping, automatically control air flow and automatically turn OFF.

Press ● COMFORT SLEEP : Select 1, 3, 5 or 9 hrs for OFF timer operation.

Note: The cooling operation, the set temperature will increase automatically 0.5 degree/hour for 4 hours (maximum 2 degrees increase). For heating operation, the set temperature will decrease.

13. SLEEP TIMER OPERATION

To start the sleep timer (OFF timer) operation

Press ● SLEEP : Select 1, 3, 5 or 9 hrs for OFF timer operation.





9-4-2. Display of Remote Control

All indications, except for the clock time indicator, are displayed by pressing the  button.

1. Transmission mark

This transmission mark ▲ indicates when the remote controller transmits signals to the indoor unit.







2. Mode indicator

Indicates the current operation mode.
(A : Auto,  : Cool,  : Dry,  : Heat,  : Fan only)

3. Temperature indicator

Indicates the temperature setting.
(17°C to 30°C)

4. FAN speed indicator

Indicates the selected fan speed.
AUTO or five fan speed levels
(LOW , LOW+ , MED , MED+ , HIGH ) can be shown.
Indicate Auto will be appear with Dry operation
( : Dry) only.

5. TIMER and clock time indicator

The time setting for timer operation or the clock time is indicated.
The current time is always indicated except during TIMER operation.

6. Hi-POWER indicator

Indicates when the Hi-POWER operation starts.
Press the Hi-POWER button to start and press it again to stop the operation.

7.  (PRESET) indicator

Flashes for 3 seconds when the PRESET button is pressed during operation.
The  mark is shown when holding down the button for more than 3 seconds while the mark is blinks.
Press another button to turn off the mark.

8. ECO indicator

Indicates when the ECO is in activated.
Press the ECO button to start and press it again to stop operation.

9. A, B change indicator remote controller

When the remote controller switching function is set, "B" appears in the remote controller display.
(When the remote controller setting is "A", there is no indication at this position.)

10. Comfort sleep

Indicates when comfort sleep is activated.
Press comfort sleep button to select

11. Quiet

Indicates when quiet is activated.
Press quiet button to start and press it again to stop operation.

12. One-Touch

Indicates when one touch comfort is activated.
Press one-touch button to start the operation.

13. Swing

Indicates when louver is swing.
Press swing button to start the swing operation and press it again to stop the swing operation.

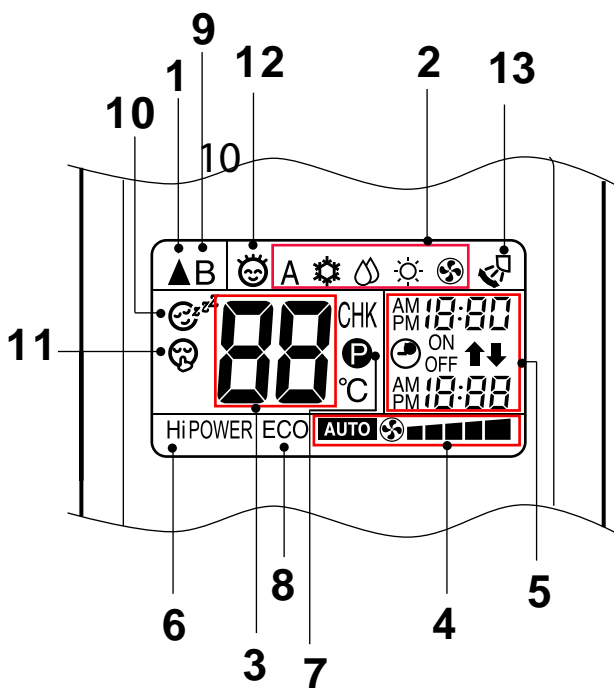

10. INSTALLATION PROCEDURE

10-1. Installation Diagram of Indoor and Outdoor Units

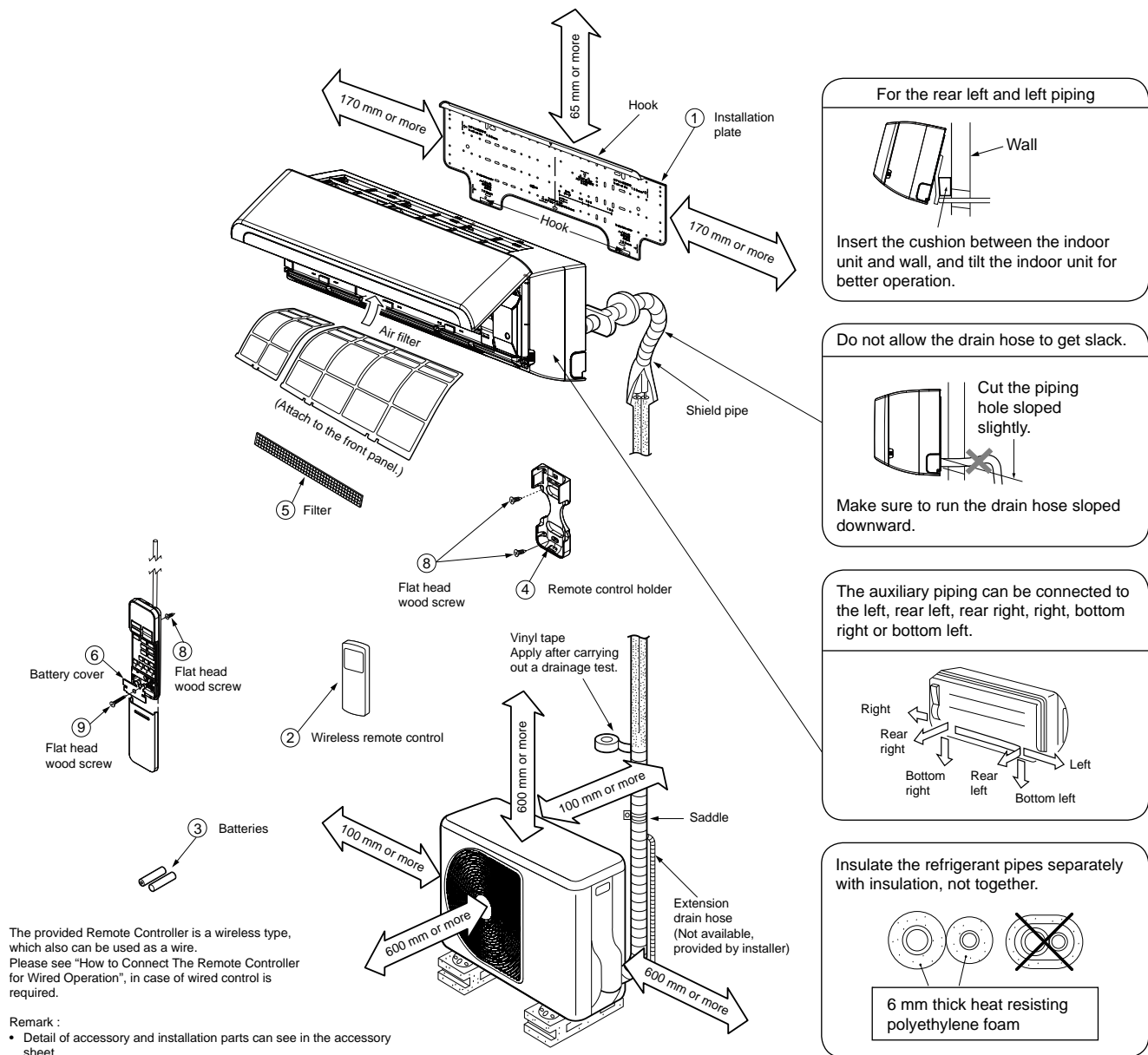

10-2. Installation

10-2-1. Optional installation parts

Part Code	Parts name	Q'ty
Ⓐ	Refrigerant piping Liquid side : $\varnothing 6.35$ mm Gas side : $\varnothing 9.52$ mm	One each
Ⓑ	Pipe insulating material (polyethylene foam, 6 mm thick)	1
Ⓒ	Putty, PVC tapes	One each

<Fixing bolt arrangement of outdoor unit>

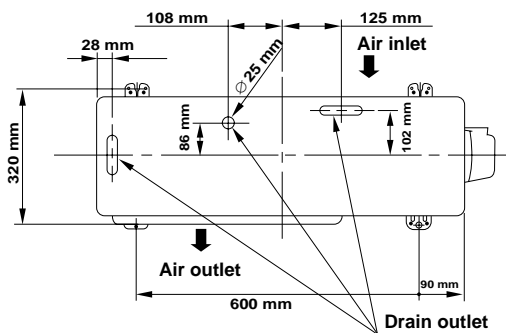
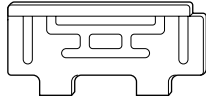
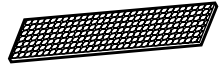





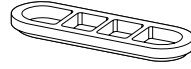



Fig. 10-2-1

- Secure the outdoor unit with fixing bolts and nuts if the unit is likely to be exposed to a strong wind.
- Use $\varnothing 8$ mm or $\varnothing 10$ mm anchor bolts and nuts.
- If it is necessary to drain the defrost water, attach drain nipple ⑩ and cap water proof ⑪ to the bottom plate of the outdoor unit before installing it.

10-2-2. Accessory and installation parts

Part No.	Part name (Q'ty)	Part No.	Part name (Q'ty)	Part No.	Part name (Q'ty)
①	 Installation plate x 1	⑤	 Toshiba New IAQ filter (L) x 1	⑨	 Flat head wood screw Ø3.1 x 25 ℓ x 1
②	 Wireless remote control x 1	⑥	 Battery-cover x 1	⑩	 Drain nipple* x 1
③	 Battery x 2	⑦	 Mounting screw Ø4 x 25 ℓ x 6	⑪	 Cap water proof x 2
④	 Remote control holder x 1	⑧	 Flat head wood screw Ø3.1 x 16 ℓ x 2		

The part marked with asterisk (*) is packaged with the outdoor unit.

Others







Name
Owner's manual
Installation manual

10-2-3. Installation/Serviceing Tools**Changes in the product and components**

In the case of an air conditioner using R410A, in order to prevent any other refrigerant from being charged accidentally, the service port diameter of the outdoor unit control valve (3 way valve) has been changed. (1/2 UNF 20 threads per inch)

- In order to increase the pressure resisting strength of the refrigerant piping flare processing diameter and size of opposite side of flare nuts has been changed. (for copper pipes with nominal dimensions 1/2 and 5/8)

New tools for R410A

New tools for R410A	Applicable to R22 model		Changes
Gauge manifold	×		As pressure is high, it is impossible to measure by means of conventional gauge. In order to prevent any other refrigerant from being charged, each port diameter has been changed.
Charge hose	×		In order to increase pressure resisting strength, hose materials and port size have been changed (to 1/2 UNF 20 threads per inch). When purchasing a charge hose, be sure to confirm the port size.
Electronic balance for refrigerant charging	○		As pressure is high and gasification speed is fast, it is difficult to read the indicated value by means of charging cylinder, as air bubbles occur.
Torque wrench (nominal diam. 1/2, 5/8)	×		The size of opposite sides of flare nuts have been increased. Incidentally, a common wrench is used for nominal diameters 1/4 and 3/8.
Flare tool (clutch type)	○		By increasing the clamp bar's receiving hole, strength of spring in the tool has been improved.
Gauge for projection adjustment	—	—	Used when flare is made by using conventional flare tool.
Vacuum pump adapter	○		Connected to conventional vacuum pump. It is necessary to use an adapter to prevent vacuum pump oil from flowing back to the charge hose. The charge hose connecting part has two ports-one for conventional refrigerant (7/16 UNF 20 threads per inch) and one for R410A. If the vacuum pump oil (mineral) mixes with R410A a sludge may occur and damage the equipment.
Gas leakage detector	×		Exclusive for HFC refrigerant.

- Incidentally, the “refrigerant cylinder” comes with the refrigerant designation (R410A) and protector coating in the U. S's ARI specified rose color (ARI color code: PMS 507).
- Also, the “charge port and packing for refrigerant cylinder” require 1/2 UNF 20 threads per inch corresponding to the charge hose's port size.

10-3. Indoor Unit

10-3-1. Installation place

- A place which provides the spaces around the indoor unit as shown in the diagram in part 8-2.
- A place where there is no obstacle near the air inlet and outlet.
- A place that allows easy installation of the piping to the outdoor unit.
- A place which allows the front panel to be opened.
- The indoor unit shall be installed as top of the indoor unit comes to at least 2 m height. Also, it must be avoided to put anything on the top of the indoor unit.

CAUTION

- Direct sunlight to the indoor unit's wireless receiver should be avoided.
- The microprocessor in the indoor unit should not be too close to RF noise sources.
(For details, see the owner's manual.)

<Remote control>

- A place where there are no obstacles such as a curtain that may block the signal from the indoor unit.
- Do not install the remote control in a place exposed to direct sunlight or close to a heating source, such as a stove.
- Keep the remote control at least 1 m apart from the nearest TV set or stereo equipment. (This is necessary to prevent image disturbances or noise interference.)
- The location of the remote control should be determined as shown below.

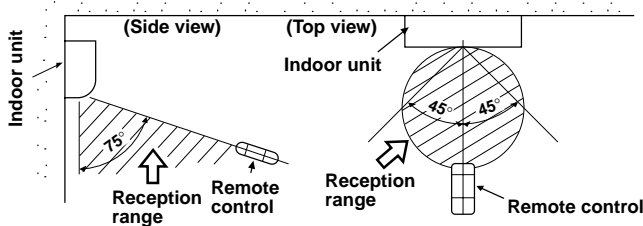

Fig. 10-3-1

10-3-2. Cutting a hole and mounting installation plate

<Cutting a hole>

When installing the refrigerant pipes from the rear.

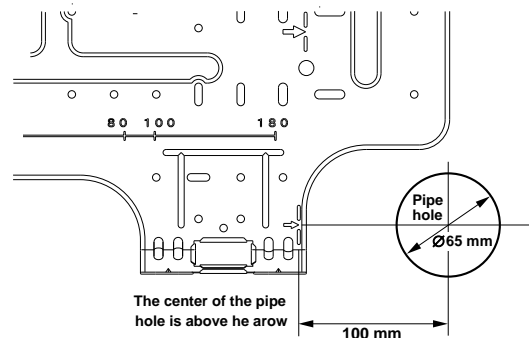

Fig. 10-3-2

1. After determining the pipe hole position on the mounting plate (→), drill the pipe hole (Ø65 mm) at a slight downward slant to the outdoor side.

NOTE

- When drilling a wall that contains a metal lath, wire lath or metal plate, be sure to use a pipe hole brim ring sold separately.

<Mounting the installation plate>

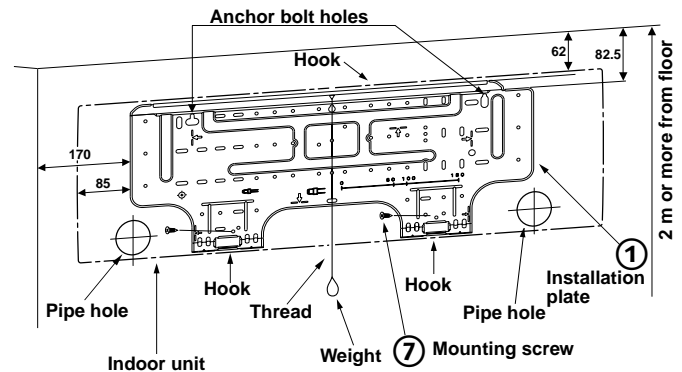

Fig. 10-3-3

<When the installation plate is directly mounted on the wall>

1. Securely fit the installation plate onto the wall by screwing it in the upper and lower parts to hook up the indoor unit.
2. To mount the installation plate on a concrete wall with anchor bolts, utilize the anchor bolt holes as illustrated in the above figure.
3. Install the installation plate horizontally in the wall.

CAUTION
 When installing the installation plate with a mounting screw, do not use the anchor bolt hole. Otherwise the unit may fall down and result in personal injury and property damage.

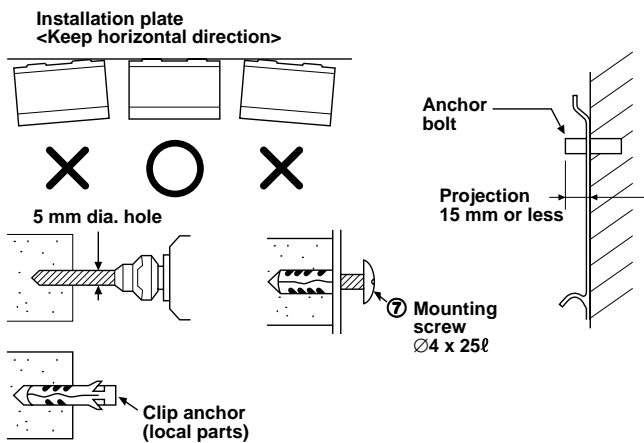

Fig. 10-3-4

CAUTION
 Failure to firmly install the unit may result in personal injury and property damage if the unit falls.

- In case of block, brick, concrete or similar type walls, make 5 mm dia. holes in the wall.
- Insert clip anchors for appropriate ⑦ mounting screws.

NOTE

- Secure four corners and lower parts of the installation plate with 4 to 6 mounting screws to install it.

10-3-3. Wiring connection

<How to connect the connecting cable>

Wiring of the connecting cable can be carried out without removing the front panel.

1. Remove the air inlet grille.
 Open the air inlet grille upward and pull it toward you.
2. Remove the terminal cover and cord clamp.
3. Insert the connecting cable (according to the local cords) into the pipe hole on the wall.
4. Take out the connecting cable through the cable slot on the rear panel so that it protrudes about 20 cm from the front.
5. Insert the connecting cable fully into the terminal block and secure it tightly with screws.
6. Tighten firmly but not over 1.2 N.m (0.12 kgf.m)
7. Secure the connecting cable with the cord clamp.
8. Fix the terminal cover, rear plate bushing and air inlet grille on the indoor unit.

CAUTION

- Be sure to refer to the wiring system diagram labeled inside the front panel.
- Check local electrical cords and also any specific wiring instructions or limitations.

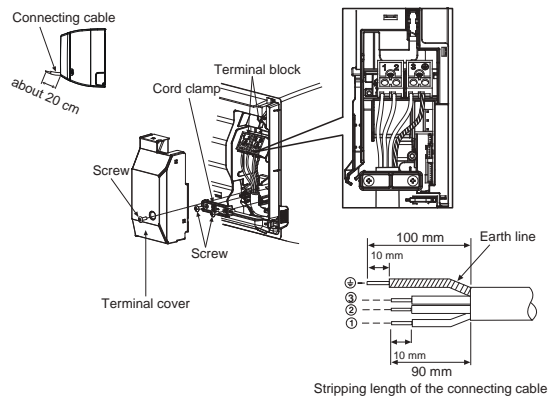

Fig. 10-3-5

NOTE

- Use stranded wire only.
- Wire type : More than H07RN-F or 60245 IEC66 (1.0 mm² or more)

<How to connect remote controller for wire operation>

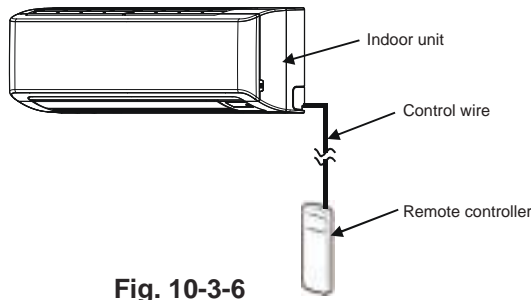

Fig. 10-3-6

For indoor unit

1. Open the air inlet grille upward.
2. Securely remove two screws at the front panel.
3. Slightly open the lower part of the front panel then pull the upper part of the front toward you to remove it from the rear plate as shown on figure ①.
4. After removing the front panel, remove the display unit and open the cover as shown on figure ② and ③.
5. Arrange the control wire as detail and specification as shown on figure ④.
6. Securely connect the control wire to terminal of display unit board as shown on figure ⑤ (tighten firmly but not over : 0.12 N·m (0.01 kgf·m)).
7. Set the control wire throughout at slot on front cover of display unit then reassembly display with main casing by reverse process of figure ② and ③. Make sure the control wire must not be pressed by front and rear cover of display unit.
8. Set the control wire out from indoor unit same portion as power supply and connecting cable as shown on figure ⑥.
9. Reassembly the indoor unit by reverse process of 1 to 3.

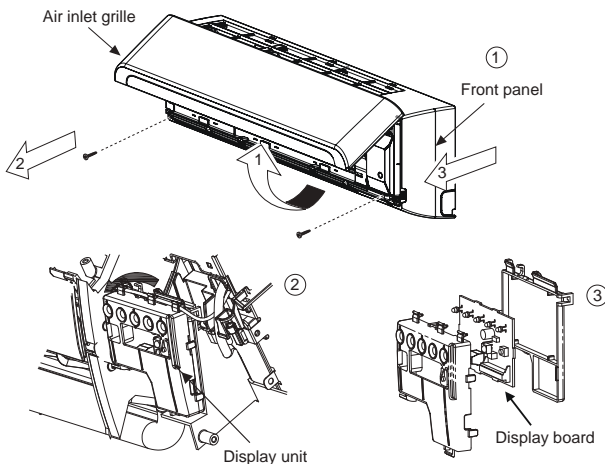

Fig. 10-3-7

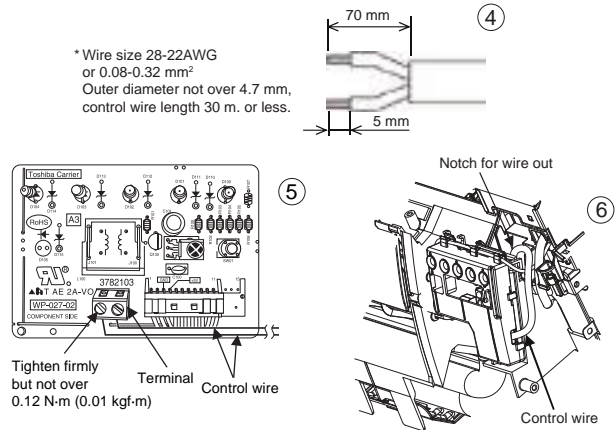

Fig. 10-3-8

For remote controller

1. Remove cover of remote controller by sliding down and take it out.
2. If batteries are exist, please take them out. The combination of using wire controller and batteries may cause of batteries explosion.
3. Make hole for insert control wire by use screwdriver break the polyester sheet as shown on figure ⑦.
4. Insert control wire from rear side of remote controller as shown on figure ⑧.
5. Fix control wire which arrange as shown on figure ⑨ and ⑩ to terminal by provided screws (tighten firmly but not over : 0.25 N·m (0.03 kgf·m)).
6. Set control wire through gutter way at rear side of remote controller as shown on figure ⑪.
7. Fix provided screw (∅ 3.1 x 16L) on the wall to hang remote controller as shown on figure ⑫.
8. Mark and arrange hole for fix below screw (∅ 3.1 x 25L) as shown on figure ⑬.
9. Assembly battery cover which provided with accessory bag then use provide screw (∅ 3.1 x 25L) to fix battery cover together with wall as shown on figure ⑭ (tighten firmly but not over 0.15 N.m (0.02 kgf.m)).
10. Reassembly cover of remote controller.

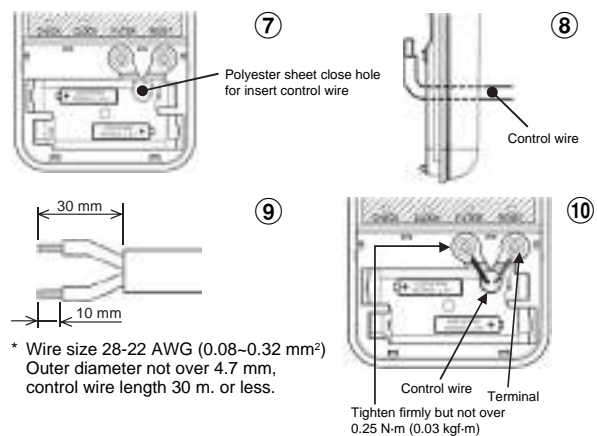

Fig. 10-3-9

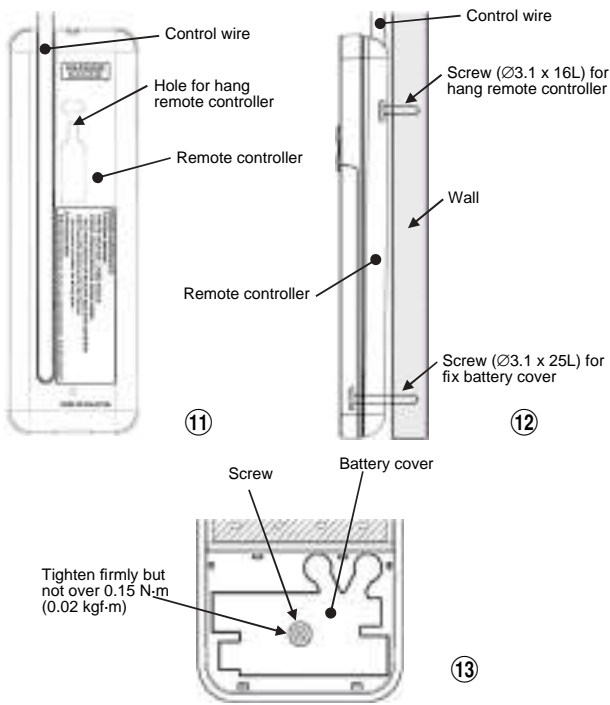

Fig. 10-3-10

***Remark :**

1. Recommend to use double insulation lead wire for connect remote control and air conditioner.
2. For wire operation, 1 remote control can control only 1 indoor unit.
3. In wire operation, remote controller will return to initial condition (PRESET, TIMER and CLOCK will return to initial condition) when user shutdown power supply of air conditioner.

<How to install the air inlet grille on the indoor unit>

- When attaching the air inlet grille, the contrary of the removed operation is performed.

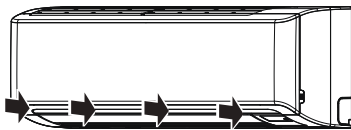

10-3-4. Piping and drain hose installation

<Piping and drain hose forming>

- * Since dewing results in a machine trouble, make sure to insulate both the connecting pipes. (Use polyethylene foam as insulating material.)

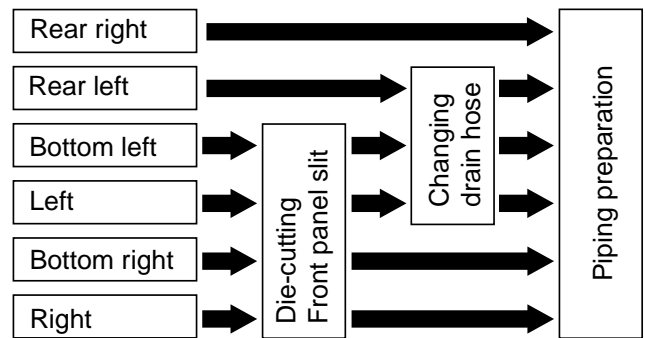

1. Die-cutting front panel slit

Cut out the slit on the left or right side of the front panel for the left or right connection and the slit on the bottom left or right side of the front panel for the bottom left or right connection with a pair of nippers.

2. Changing drain hose

For leftward connection, bottom leftward connection and rear leftward connection's piping, it is necessary to change the drain hose and drain cap.

How to remove the drains cap

Clip drain cap by needle-nose plier, and pull out.

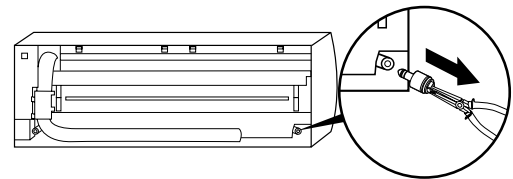

Fig. 10-3-11

How to install the drain hose

Firmly insert drain hose connecting part until hitting on a heat insulator and fix it with a screw.

How to remove the drain hose

- The drain hose can be removed by take off screw, after that twisting and pulling.
- When removing the drain hose, be careful of any sharp edges of steel plate. The edges can cause injuries.
- To install the drain hose, insert the drain hose firmly until the connection part contacts with heat insulator, and the secure it with original screw.

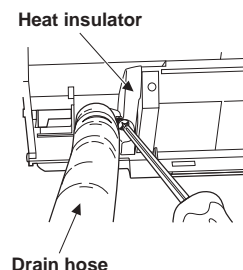

Fig. 10-3-12

How to fix the drains cap

- 1) Insert hexagonal wrench (4 mm) in a center head.

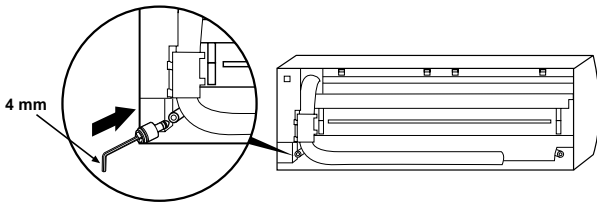

Fig. 10-13-13

- 2) Firmly insert drains cap.

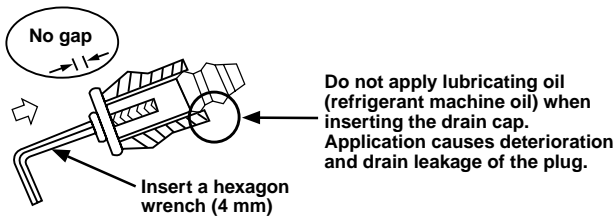

Fig. 10-13-14

CAUTION

Firmly insert the drain hose and drain cap; otherwise, water may leak.

<In case of right or left piping>

After scribing slits of the front panel with a knife or a making-off pin, cut them with a pair of nippers or an equivalent tool.

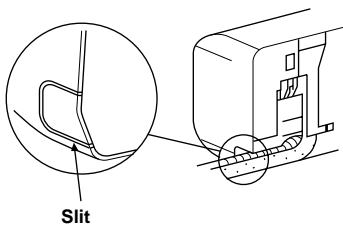

Fig. 10-13-15

<In case of bottom right or bottom left piping>

After scribing slits of the front panel with a knife or a making-off pin, cut them with a pair of nippers or an equivalent tool.

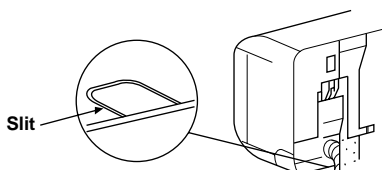

Fig. 10-13-16

<Left-hand connection with piping>

Bend the connecting pipe so that it is laid within 43 mm above the wall surface. If the connecting pipe is laid exceeding 43 mm above the wall surface, the indoor unit may unstably be set on the wall. When bending the connecting pipe, make sure to use a spring bender so as not to crush the pipe.

Bend the connection pipe within a radius of 30 mm.
To connect the pipe after installation of the unit (figure)

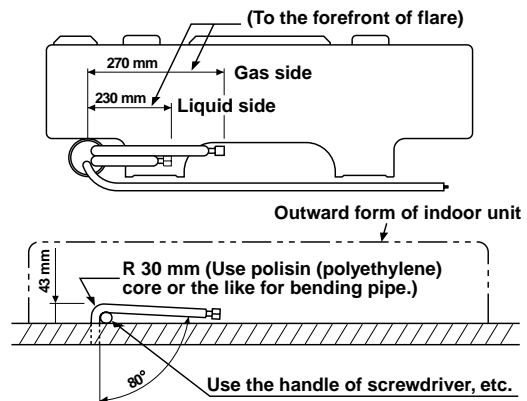

Fig. 10-3-17

NOTE

If the pipe is bent incorrectly, the indoor unit may unstably be set on the wall. After passing the connecting pipe through the pipe hole, connect the connecting pipe to the auxiliary pipes and wrap the facing tape around them.

CAUTION

Bind the auxiliary pipes (two) and connecting cable with facing tape tightly. In case of leftward piping and rear-leftward piping, bind the auxiliary pipes (two) only with facing tape.

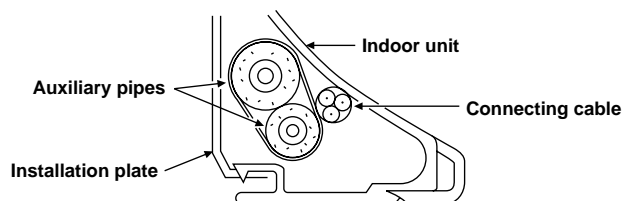

Carefully arrange pipes so that any pipe does not stick out of the rear plate of the indoor unit. Carefully connect the auxiliary pipes and connecting pipes to each other and cut off the insulating tape wound on the connecting pipe to avoid double-taping at the joint, moreover, seal the joint with the vinyl tape, etc. Since dewing results in a machine trouble, make sure to insulate both the connecting pipes. (Use polyethylene foam as insulating material.) When bending a pipe, carefully do it, not to crush it.

10-3-5. Indoor unit fixing

1. Pass the pipe through the hole in the wall, and hook the indoor unit on the installation plate at the upper hooks.
2. Swing the indoor unit to right and left to confirm that it is firmly hooked up on the installation plate.
3. While pressing the indoor unit onto the wall, hook it at the lower part on the installation plate. Pull the indoor unit toward you to confirm that it is firmly hooked up on the installation plate.

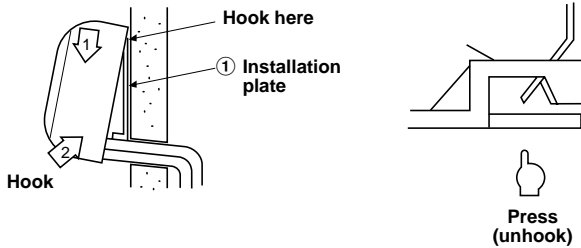

Fig. 10-3-18

For detaching the indoor unit from the installation plate, pull the indoor unit toward you while pushing its bottom up at the specified parts.

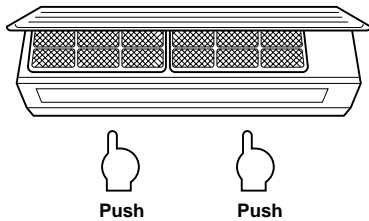

Fig. 10-3-19

10-3-6. Drainage

1. Run the drain hose sloped downwards.

NOTE

Hole should be made at a slight downward slant on the outdoor side.

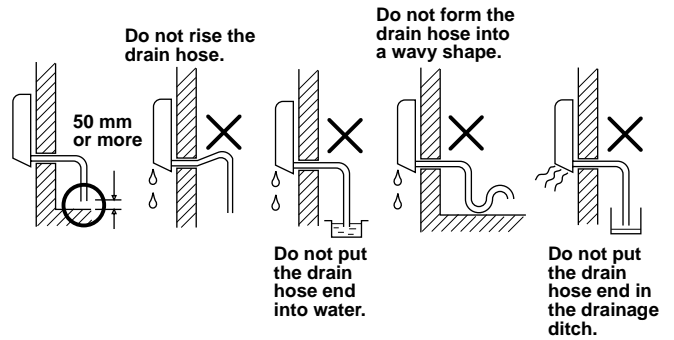

Fig. 10-3-20

2. Put water in the drain pan and make sure that the water is drained out of doors.
3. When connecting extension drain hose, insulate the connecting part of extension drain hose with shield pipe.

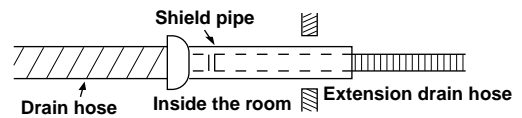

Fig. 10-3-21

CAUTION

Arrange the drain pipe for proper drainage from the unit.
Improper drainage can result in dew-dropping.

This air conditioner has the structure designed to drain water collected from dew, which forms on the back of the indoor unit, to the drain pan. Therefore, do not store the power cord and other parts at a height above the drain guide.

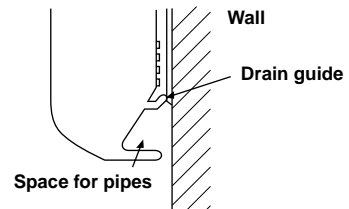

Fig. 10-3-22

10-4. Outdoor Unit

10-4-1. Installation place

- A place which provides the spaces around the outdoor unit as shown in the left diagram.
- A place which can bear the weight of the outdoor unit and does not allow an increase in noise level and vibration.
- A place where the operation noise and discharged air do not disturb your neighbors.
- A place which is not exposed to a strong wind.
- A place free of a leakage of combustible gases.
- A place which does not block a passage.
- When the outdoor unit is to be installed in an elevated position, be sure to secure its feet.
- The allowable pipe length is up to 20 m. If the length is over 15 m, add 20 g of refrigerant for every additional meter of the pipe length for all models.
- The allowable height of outdoor unit installation site is up to 10 m.
- A place where the drain water does not raise any problem.

CAUTION

1. Install the outdoor unit without anything blocking the air discharging.
2. When the outdoor unit is installed in a place exposed always to a strong wind like a coast or on a high story of a building, secure the normal fan operation using a duct or a wind shield.
3. Specially in windy area, install the unit to prevent the admission of wind.
4. Installation in the following places may result in trouble.
Do not install the unit in such places.
 - A place full of machine oil.
 - A saline-place such as the coast.
 - A place full of sulfide gas.
 - A place where high-frequency waves are likely to be generated as from audio equipment, welders, and medical equipment.

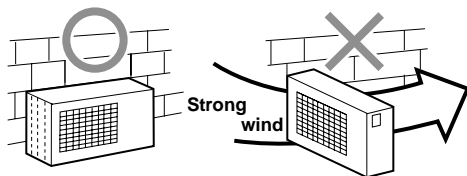

Fig. 10-4-1

10-4-2. Refrigerant piping connection

<Flaring>

1. Cut the pipe with a pipe cutter.

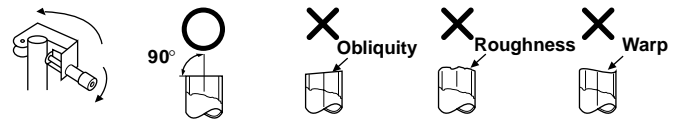

Fig. 10-4-2

2. Insert a flare nut into the pipe, and flare the pipe.

- **Projection margin in flaring : A (Unit : mm)**

Rigid (clutch type)

Outer dia. of copper pipe	A	
	Rigid	Imperial
∅ 6.35	0 to 0.5	1.0 to 1.5
∅ 9.52	0 to 0.5	1.0 to 1.5
∅ 12.70	0 to 0.5	1.0 to 1.5

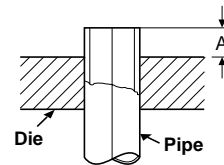

Fig. 10-4-3

Imperial (wing nut type)

Outer dia. of copper pipe	R410A
∅ 6.35	1.5 to 2.0
∅ 9.52	1.5 to 2.0
∅ 12.70	2.0 to 2.5

<Tightening connection>

Align the centers of the connecting pipes and tighten the flare nut as far as possible with your fingers. Then tighten the nut with a spanner and torque wrench as shown in the figure.

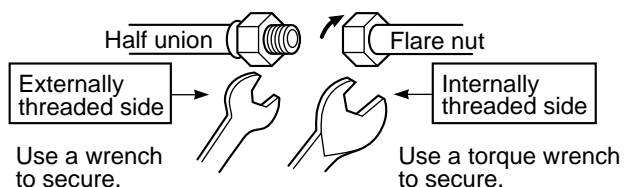

Fig. 10-4-4

CAUTION

Do not apply excess torque.
Otherwise, the nut may crack depending on the conditions.

(Unit : N·m)

Outer dia. of copper pipe	Tightening torque
Ø6.35	16 to 18 (1.6 to 1.8 kgf·m)
Ø9.52	30 to 42 (3.0 to 4.2 kgf·m)
Ø12.70	50 to 62 (5.0 to 6.2 kgf·m)

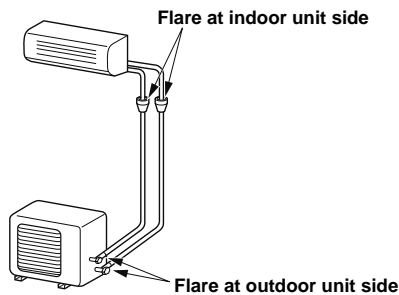

Fig. 10-4-5

<Shaping pipes>

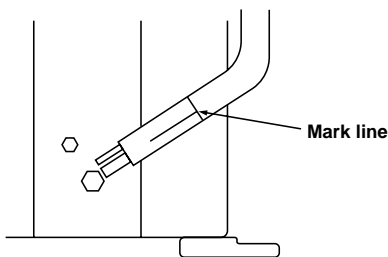

Fig. 10-4-6

1. How to shape the pipes. Shape the pipes along the incused line on the outdoor unit.
2. How to fit position of the pipes. Put the edges of the pipes to the place with a distance of 85 mm from the incused line.

10-4-3. Evacuating

After the piping has been connected to the indoor unit, you can perform the air purge together at once.

AIR PURGE

Evacuate the air in the connecting pipes and in the indoor unit using a vacuum pump. Do not use the refrigerant in the outdoor unit.
For details, see the manual of the vacuum pump.

<Using a vacuum pump>

Be sure to use a vacuum pump with counter-flow prevention function so that inside oil of the pump does not flow backward into pipes of the air conditioner when the pump stops.

(If oil inside of the vacuum pump enters the air conditioner, which use R410A, refrigeration cycle trouble may result.)

1. Connect the charge hose from the manifold valve to the service port of the gas side packed valve at gas side.
2. Connect the charge hose to the port of the vacuum pump.
3. Open fully the low pressure side handle of the gauge manifold valve.
4. Operate the vacuum pump to start evacuating. Perform evacuating for about 15 minutes if the piping length is 20 meters. (15 minutes for 20 meters) (assuming a pump capacity of 27 liters per minute.) Then confirm that the compound pressure gauge reading is -101 kPa (-76 cmHg).
5. Close the low pressure side valve handle of gauge manifold valve.
6. Open fully the valve stem of the packed valves (both gas and liquid sides).
7. Remove the charging hose from the service port.
8. Securely tighten the caps on the packed valves.

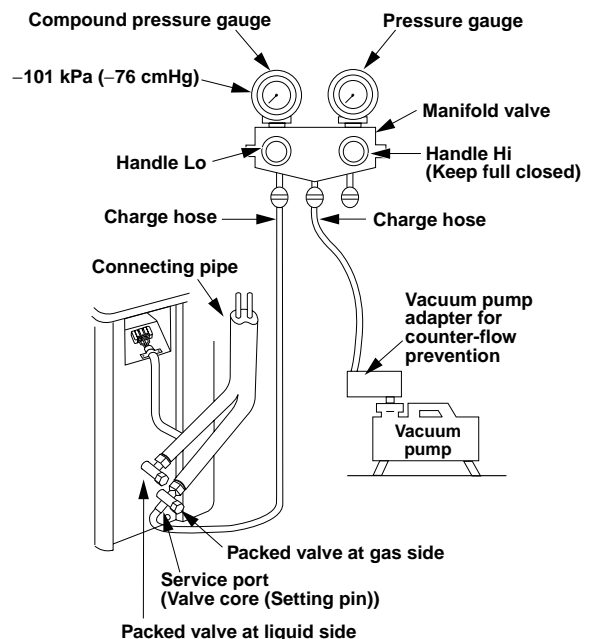

Fig. 10-4-7

CAUTION

KEEP IMPORTANT 5 POINTS FOR PIPING WORK

- (1) Take away dust and moisture (Inside of the connecting pipes.)
- (2) Tight connection (between pipes and unit)
- (3) Evacuate the air in the connecting pipes using VACUUM PUMP.
- (4) Check gas leak (connected points)
- (5) Be save to fully open the packed valves before operation.

<Packed valve handling precautions>

- Open the valve stem all the way out, but do not try to open it beyond the stopper.

Pipe size of Packed Valve	Size of Hexagon wrench
12.70 mm and smaller	A = 4 mm
15.88 mm	A = 5 mm

- Securely tighten the valve cap with torque in the following table

Cap	Cap Size (H)	Torque
Valve Rod Cap	H17 - H19	14~18 N.m (1.4 to 1.8 kgf·m)
	H22 - H30	33~42 N.m (3.3 to 4.2 kgf·m)
Service Port Cap	H14	8~12 N.m (0.8 to 1.2 kgf·m)
	H17	14~18 N.m (1.4 to 1.8 kgf·m)

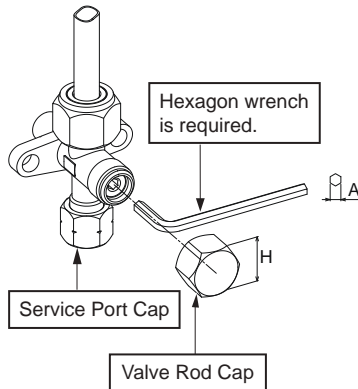

Fig. 10-4-8

10-4-4. Electrical work

1. The power supply line must be supplied to outdoor unit.
2. The supply voltage must be the same as the rated voltage of the air conditioner.
3. Prepare the power source for exclusive use with the air conditioner.

NOTE

- Wire type : More than H07RN-F or 60245 IEC66 (1.5 mm² or more)

CAUTION

- Connection to fixed wiring: A switch or circuit breaker which disconnects all poles and has a contact separation of at least 3 mm must be incorporated in the fixed wiring. An approved circuit breaker or switches must be used.
- Perform wiring works so as to allow a general wiring capacity.

10-4-5. Wiring connection

1. Remove the valve cover from the outdoor unit.
2. Connect power cord to the terminal block **L**, **N** and **⊥** then connect the connecting cable to the terminals as identified with their respective matched numbers on the terminal block of indoor and outdoor unit.
3. Insulate the unused cords (conductors) from any water coming in the outdoor unit. Proceed them so that they do not touch any electrical or metal parts.

<Stripping length of the connecting cable>

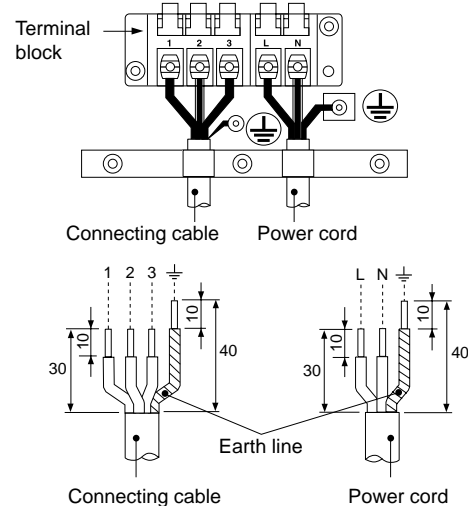

Fig. 10-4-9

Model	RAS-13N3KV-E
Power source	50 Hz, 220-240V Single phase 60 Hz, 220-230V Single phase
Maximum running current	9.1A
Circuit breaker	12.0A
Power cord	More than H07RN-F or 60245 IEC66 (1.5 mm ² or more)
Connecting cable	More than H07RN-F or 60245 IEC66 (1.0 mm ² or more)

CAUTION

- Wrong wiring connection may cause some electrical parts burn out.
- Be sure to comply with local cords on running the wire from indoor unit to outdoor unit (size of wire and wiring method, etc.).
- Every wire must be connected firmly.
- This installation circuit breaker must be used specified for the power supply line of this air conditioner.
- If incorrect or incomplete wiring is carried out, it will cause an ignition or smoke.
- Prepare the power supply for exclusive use with the air conditioner.
- This product can be connected to the mains. Connection to fixed wiring: A switch which disconnects all poles and has a contact separation of at least 3 mm must be incorporated in the fixed wiring

10-5. Others

10-5-1. Gas leak test

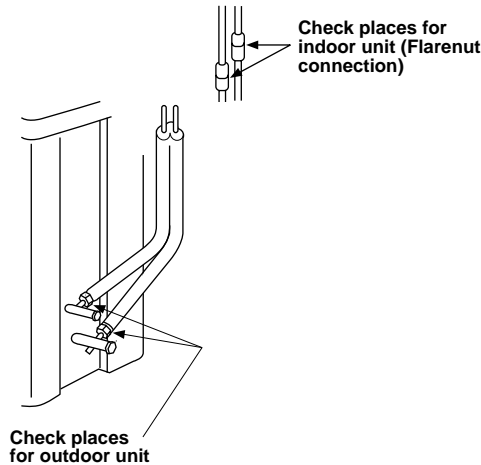

Fig. 10-5-1

- Check the flare nut connections for the gas leak with a gas leak detector or soap water.

10-5-2. Remote Control A-B Selection

- When two indoor units are installed in the same room or adjacent two rooms, if operating a unit, two units may receive the remote control signal simultaneously and operate. In this case, the operation can be preserved by setting either one remote control to B setting. (Both are set to A setting in factory shipment.)
- The remote control signal is not received when the settings of indoor unit and remote control are different.
- There is no relation between A setting/B setting and A room/B room when connecting the piping and cables.

<Remote control A-B selection>

To separate using of remote control for each indoor unit in case of 2 air conditioners are installed nearby.

<Remote Control B Setup>

1. Press [RESET] button on the indoor unit to turn the air conditioner ON.
2. Point the remote control at the indoor unit.
3. Push and hold [CHECK] button on the Remote Control by the tip of the pencil. "00" will be shown on the display (Picture ①)
4. Press [MODE] during pushing [CHECK]. "B" will show on the display and "00" will disappear and the air conditioner will turn OFF. The Remote Control B is memorized [Picture ②].

- NOTE :**
1. Repeat above step to reset Remote Control to be A.
 2. Remote Control A has not "A" display.
 3. Default setting of Remote Control from factory is A.

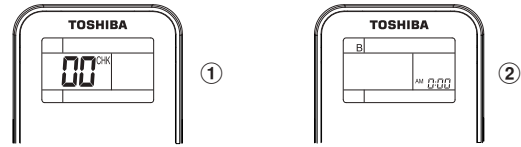

Fig. 10-5-2

10-5-3. Test operation

To switch the TEST RUN (COOL) mode, press RESET button for 10 sec.
(The beeper will make a short beep.)

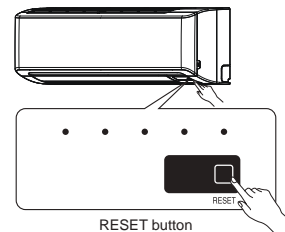

Fig. 10-5-3

10-5-4. Auto restart setting

This product is designed so that, after a power failure, it can restart automatically in the same operating mode as before the power failure.

Information

The product was shipped with Auto Restart function in the off position. Turn it on as required.

<How to set the auto restart>

1. Press and hold the [RESET] button on the indoor unit 3 seconds to set the operation. (3 beep sound and OPERATION lamp blink 5 time/sec for 5 seconds)
2. Press and hold the [RESET] button on the indoor unit for 3 seconds to cancel the operation. (3 beep sound but OPERATION lamp does not blink)
 - In case of ON timer or OFF timer are set, AUTO RESTART OPERATION dose not activate.

11. HOW TO DIAGNOSE THE TROUBLE

The pulse motor circuits are mounted to both indoor and outdoor units. Therefore, diagnose troubles according to the trouble diagnosis procedure as described below. (Refer to the check points in servicing written on the wiring diagrams attached to the indoor/outdoor units.)

Table 11-1

No.	Troubleshooting Procedure	No.	Troubleshooting Procedure
1	First Confirmation	6	How to Check Simply the Main Parts
2	Primary Judgment	7	Troubleshooting
3	Judgment by Flashing LED of Indoor Unit	8	How to Diagnose Trouble in Outdoor Unit
4	Self-Diagnosis by Remote Controller	9	How to Check Simply the Main Parts
5	Judgment of Trouble by Every Symptom	10	How to Simply Judge Whether Outdoor Fan Motor is Good or Bad

◆ Precautions when handling the new inverter (3DV Inverter)

⚠ CAUTION: HIGH VOLTAGEN

The high voltage circuit is incorporated.

Be careful to do the check service, as the electric shock may be caused in case of touching parts on the P.C. board by hand.

The new inverter (3DV inverter) will be incorporated starting with this unit.

(3DV: 3-shunt Discrete Vector control)

◆ The control circuitry has an uninsulated construction.

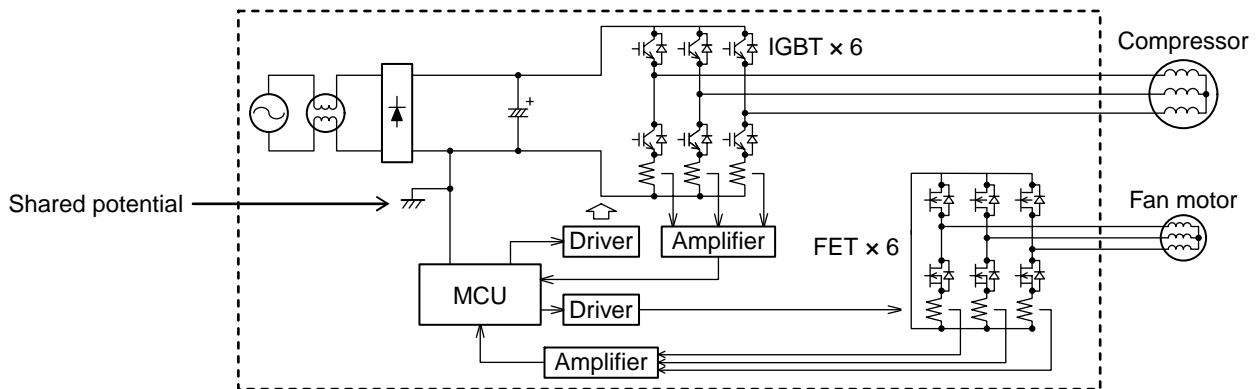

Fig. 11-1

⚠ CAUTION

A high voltage (equivalent to the supply voltage) is also energized to ground through the sensors, PMV and other low-voltage circuits. The sensor leads and other wires are covered with insulated tubes for protection. Nevertheless, care must be taken to ensure that these wires are not pinched.

Take sufficient care to avoid directly touching any of the circuit parts without first turning off the power.

At times such as when the circuit board is to be replaced, place the circuit board assembly in a vertical position.

Laying the board flat on an electrically conductive object (such as the top panel of the air conditioner's outdoor unit) while a charge is still retained by the electrolytic capacitors of the inverter's main circuit may cause short-circuiting between the electrolytic capacitors and secondary circuit components and result in damage to the components.

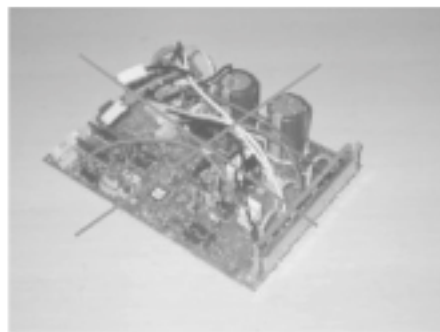
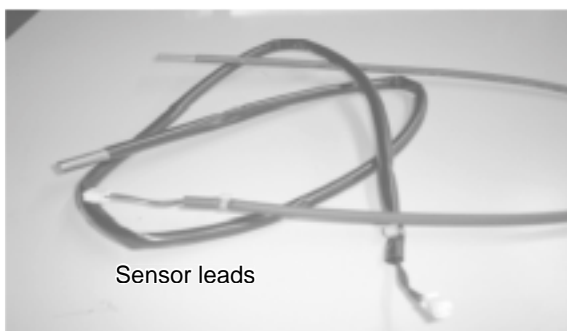

Fig. 11-2

Do NOT lay the circuit board assembly flat.

◆ Precautions when inspecting the control section of the outdoor unit

NOTE :

A large-capacity electrolytic capacitor is used in the outdoor unit controller (inverter). Therefore, if the power supply is turned off, charge (charging voltage DC280 to 380V) remains and discharging takes a lot of time. After turning off the power source, if touching the charging section before discharging, an electrical shock may be caused. Discharge the electrolytic capacitor completely by using soldering iron, etc.

< Discharging method >

1. Remove the inverter cover (plating) by opening four mounting claws.
2. As shown below, connect the discharge resistance (approx. $100\Omega/40W$) or plug of the soldering iron to voltage between + – terminals of the C14 ("CAUTION HIGH VOLTAGE" is indicated.) electrolytic capacitor on P.C. board, and then perform discharging.

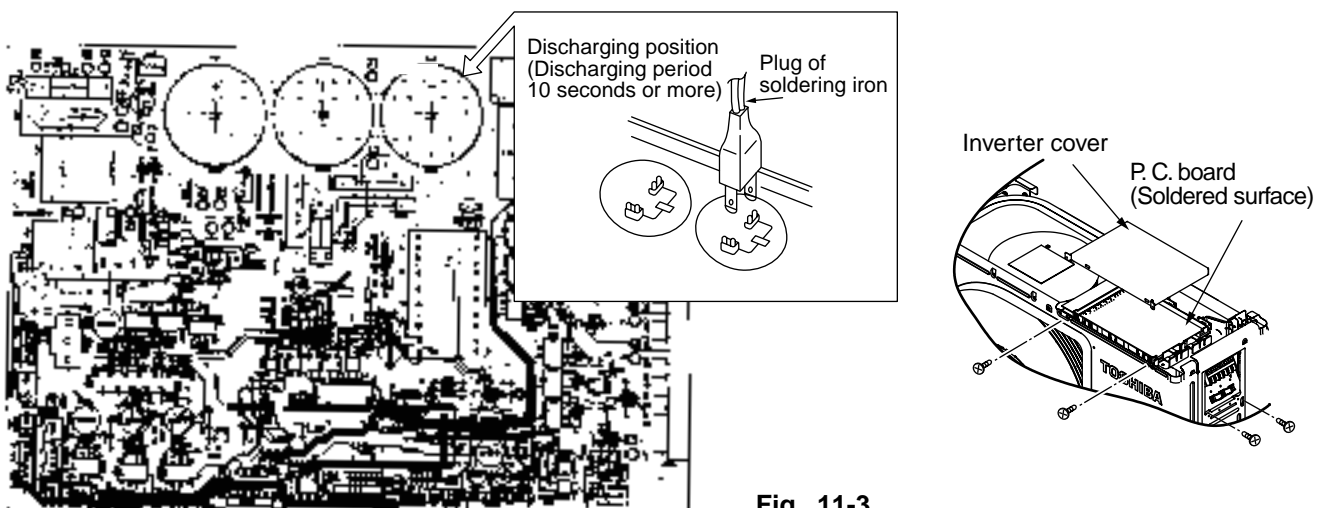

Fig. 11-3

11-1. First Confirmation**11-1-1. Confirmation of Power Supply**

Confirm that the power breaker operates (ON) normally.

11-1-2. Confirmation of Power Voltage

Confirm that power voltage is AC 220–230–240 ± 10%.

If power voltage is not in this range, the unit may not operate normally.

11-1-3. Operation Which is not a Trouble (Program Operation)

For controlling the air conditioner, the program operations are built in the microcomputer as described in the following table.

If a claim is made for running operation, check whether or not it meets to the contents in the following table.

When it does, we inform you that it is not trouble of equipment, but it is indispensable for controlling and maintaining of air conditioner.

Table 11-1-1

No.	Operation of air conditioner	Description
1	When power breaker is turned "ON", the operation indicator (Green) of the indoor unit flashes.	The OPERATION lamp of the indoor unit flashes when power source is turned on. If [⏻] button is operated once, flashing stops. (Flashes also in power failure)
2	Compressor may not operate even if the room temperature is within range of compressor-ON.	The compressor does not operate while compressor restart delay timer (3-minutes timer) operates. The same phenomenon is found after power source has been turned on because 3-minutes timer operates.
3	In Dry and ECO mode, FAN (air flow) display does not change even though FAN (air flow select) button is operated.	The air flow indication is fixed to [AUTO].
4	Increasing of compressor motor speed stops approx. 30 seconds after operation started, and then compressor motor speed increases again approx. 30 seconds after.	For smooth operation of the compressor, the compressor motor speed is restricted to Max. 41 rps for 2 minutes, and Max.91 rps for 2 minutes to 3 minutes, respectively after the operation has started.
5	In AUTO mode, the operation mode is changed.	After selecting Cool or Heat mode, select an operation mode again if the compressor keeps stop status for 15 minutes.
6	In HEAT mode, the compressor motor speed does not increase up to the maximum speed or decreases before the temperature arrives at the set temperature.	The compressor motor speed may decrease by high-temp. release control (Release protective operation by temp.-up of the indoor heat exchanger) or current release control.

11-2. Primary Judgment

To diagnose the troubles, use the following methods.

- 1) Judgment by flashing LED of indoor unit
- 2) Self-diagnosis by service check remote controller
- 3) Judgment of trouble by every symptom

Firstly use the method 1) for diagnosis. Then, use the method 2) or 3) to diagnose the details of troubles.

11-3. Judgment by Flashing LED of Indoor Unit

While the indoor unit monitors the operation status of the air conditioner, if the protective circuit operates, the contents of self-diagnosis are displayed with block on the indoor unit indication section.

Table 11-3-1

	Item	Check code	Block display	Description for self-diagnosis
<div style="border: 1px solid black; padding: 5px; width: fit-content;">Indoor indication lamp flashes.</div> <p style="text-align: center;">↓</p> <div style="border: 1px solid black; padding: 5px; width: fit-content;">Which lamp does flash?</div> <p style="text-align: center;">↓</p> <p style="text-align: center;">→</p>	A	—	OPERATION (Green) Flashing display (1 Hz)	Power failure (when power is ON)
	B	00	OPERATION (Green) Flashing display (5 Hz)	Protective circuit operation for indoor P.C. board
	C	01	OPERATION (Green) TIMER (Yellow) Flashing display (5 Hz)	Protective circuit operation for connecting cable and serial signal system
	D	02	OPERATION (Green) FILTER (Orange) Flashing display (5 Hz)	Protective circuit operation for outdoor P.C. board
	E	03	OPERATION (Green) TIMER (Yellow) FILTER (Orange) Flashing display (5 Hz)	Protective circuit operation for others (including compressor)

NOTES :

1. The contents of items B and C and a part of item E are displayed when air conditioner operates.
2. When item B and C, and item B and a part of item E occur concurrently, priority is given to the block of item B.
3. The check codes can be confirmed on the remote controller for servicing.

11-4. Self-Diagnosis by Remote Controller (Check Code)

1. If the lamps are indicated as shown B to E in Table 11-3-1, execute the self-diagnosis by the remote controller.
2. When the remote controller is set to the service mode, the indoor controller diagnoses the operation condition and indicates the information of the self-diagnosis on the display of the remote controller with the check codes. If a fault is detected, all lamps on the indoor unit will flash at 5Hz and it will beep for 10 seconds (Beep, Beep, Beep ...). The timer lamp usually flashes (5Hz) during self-diagnosis.

11-4-1. How to Use Remote Controller in Service Mode

1 Press [CHECK] button with a tip of pencil to set the remote controller to the service mode.

- "00" is indicated on the display of the remote controller.

2 Press [ON ▲] or [OFF ▲] button

If there is no fault with a code, the indoor unit will beep once (Beep) and the display of the remote controller will change as follows :

→ 00 → 01 → 02 ... 1d → 1E → 33 →

- The TIMER indicator of the indoor unit flashes continuously. (5 times per 1 sec.)
- Check the unit with all 52 check codes (00 to 33) as shown in Table-11-4-1.
- Press [ON▼] or [OFF ▼] button to change the check code backward.

If there is a fault, the indoor unit will beep for 10 seconds (Beep, Beep, Beep...).

Note the check code on the display of the remote controller.

- 2-digits alphanumeric will be indicated on the display.
- All indicators on the indoor unit will flash. (5 times per 1 sec.)

3 Press [CLR] button. After service finish for clear service code in memory.

- "7F" is indicated on the display of the remote control.

4 Press [⏻] button to release the service mode.

- The display of the remote controller returns to as it was before service mode was engaged.

Alphanumeric characters are used for the check codes.

5 is 5.	6 is 6.
A is A.	B is B.
C is C.	D is D.

Fig. 9-4-1

11-4-2. Caution at Servicing

1. After servicing, press the [ϕ] button to return to the normal mode.
2. After servicing by the check code, turn off breaker of the power supply, and turn on breaker of the power supply again so that memory in the microcomputer returns the initial status.
However, the check codes are not deleted even if the power supply is turned off because they are stored in the fixed memory.
3. After servicing, press [CLR] button under check mode status and then send the check code "7F" to the indoor unit. The error code stored in memory is cleared.

Table 11-4-1

Block distinction		Operation of diagnosis function				Judgment and action
Check code	Block	Check code	Cause of operation	Air conditioner status	Remarks	
00	Indoor P.C. board etc.	01	Short-circuit or disconnection of the room temperature sensor (TA sensor).	Operation continues.	Displayed when error is detected.	1. Check the room temp. sensor. 2. When the room temp. sensor is normal, check P.C. board.
		02	Being out of place, disconnection, short-circuit, or migration of heat exchanger sensor (TC sensor)	Operation continues.	Displayed when error is detected.	1. Check heat exchanger sensor. 2. When heat exchanger sensor is normal, check P.C. board.
		11	Lock of indoor fan or trouble on the indoor fan circuit	All off	Displayed when error is detected.	1. Check the motor. 2. When the motor is normal, check P.C. board.
	Not displayed	12	Trouble on other indoor P.C. boards	Operation continues.	Displayed when error is detected.	Replace P.C. board.
01	Connecting cable and serial signal	04	Return serial signal is not sent to indoor side from operation started. 1) Defective wiring of connecting cable 2) Operation of compressor thermo Gas shortage Gas leak	Operation continues.	Flashes when trouble is detected on Return serial signal, and normal status when signal is reset.	1. When the outdoor unit never operate: 1) Check connecting cable, and correct if defective wiring. 2) Check 25A fuse of inverter P.C. board. 3) Check 3.15A of inverter P.C. board. 2. To display [Other] block during operation, check compressor thermo. operation and supply gas (check gas leak also). 3. Unit operates normally during check. If return serial signal does not stop between indoor terminal 2 and 3, replace inverter P.C. board. If signal stops between indoor terminal 2 and 3, replace indoor P.C. board.

Block distinction		Operation of diagnosis function				Judgment and action
Check code	Block	Check code	Cause of operation	Air conditioner status	Remarks	
02	Outdoor P.C. board	14	Inverter over-current protective circuit operates. (Short time)	All off	Displayed when error is detected.	Even if trying operation again, all operations stop immediately. : Replace P.C. board.
		15	Position-detect circuit error or short-circuit between windings of compressor	All off	Displayed when error is detected.	1. Even if connecting lead wire of compressor is removed, position-detect circuit error occurred. : Replace P.C. board. 2. Measure resistance between wires of compressor, and perform short-circuit. : Replace compressor.
		17	Current-detect circuit error	All off	Displayed when error is detected.	Even if trying operation again, all operations stop immediately. : Replace P.C. board.
		18	Being out of place, disconnection or short-circuit of the outdoor heat exchanger sensor (TE) or suction temp. sensor (Ts)	All off	Displayed when error is detected.	1. Check sensors (TE, TS). 2. Check P.C. board.
		19	Disconnection or short-circuit of discharge temp. sensor	All off	Displayed when error is detected.	1. Check discharge temp. sensor (TD). 2. Check P.C. board
		1A	Outdoor fan drive system error	All off	Displayed when error is detected.	Position-detect error, over-current protective operation of outdoor fan drive system, fan lock, etc. : Replace P.C. board or fan motor.
	Not displayed	16	Outdoor heat exchanger temp. sensor error	Operation continues	—	1. Check outdoor temp. sensor (TO). 2. Check P.C. board.
Outdoor P.C. board	1E	Compressor drive output error, Compressor error (lock, missing, etc.), Break down	All off	Displayed when error is detected.	When 20 seconds passed after start-up, position-detect circuit error occurred. : Replace compressor. Trouble on P.M.V.	
03	Others (including compressor)	07	Return serial signal has been sent when operation started, but it is not sent from halfway. 1) Compressor thermo. operation Gas shortage Gas leak 2) Instantaneous power failure	Operation continues	Flashes when trouble is detected on return serial signal, and normal status when signal is reset.	1. Repeat Start and Stop with interval of approx. 10 to 40 minutes. (Code is not displayed during operation.) Supply gas. (Check also gas leak). 2. Unit operates normally during check. If return serial signal does not stop between indoor terminal block 2 and 3, replace inverter P.C. board. If signal stops between indoor terminal block 2 and 3, replace indoor P.C. board.
		1D	Compressor does not rotate. (Current protective circuit does not operate when a specified time passed after compressor had been activated.)	All off	Displayed when error is detected.	1. Trouble on compressor 2. Trouble on wiring of compressor (Missed phase)
		1E	Discharge temp. exceeded 117°C	All off	Displayed when error is detected.	1. Check discharge temp. sensor (TD). 2. Gas leakage 3. Trouble on P.M.V.
		1F	Break down of compressor	All off	Displayed when error is detected.	1. Check power voltage. (220–230–240 V +10%) 2. Overload operation of refrigeration cycle Check installation condition (Short-circuit of outdoor diffuser).
		08	4-way valve inverse error (TC sensor value lowered during heating operation.)	Operation continues	—	1. Check 4-way valve operation.

11-5. Judgment of Trouble by Every Symptom

11-5-1. Indoor Unit (Including Remote Controller)

(1) Power is not turned on (Does not operate entirely)

<Primary check>

1. Is the supply voltage normal?
2. Is the normal voltage provided to the outdoor unit?
3. Is the crossover cable connected properly?
4. Is the fuse (F01) blown?

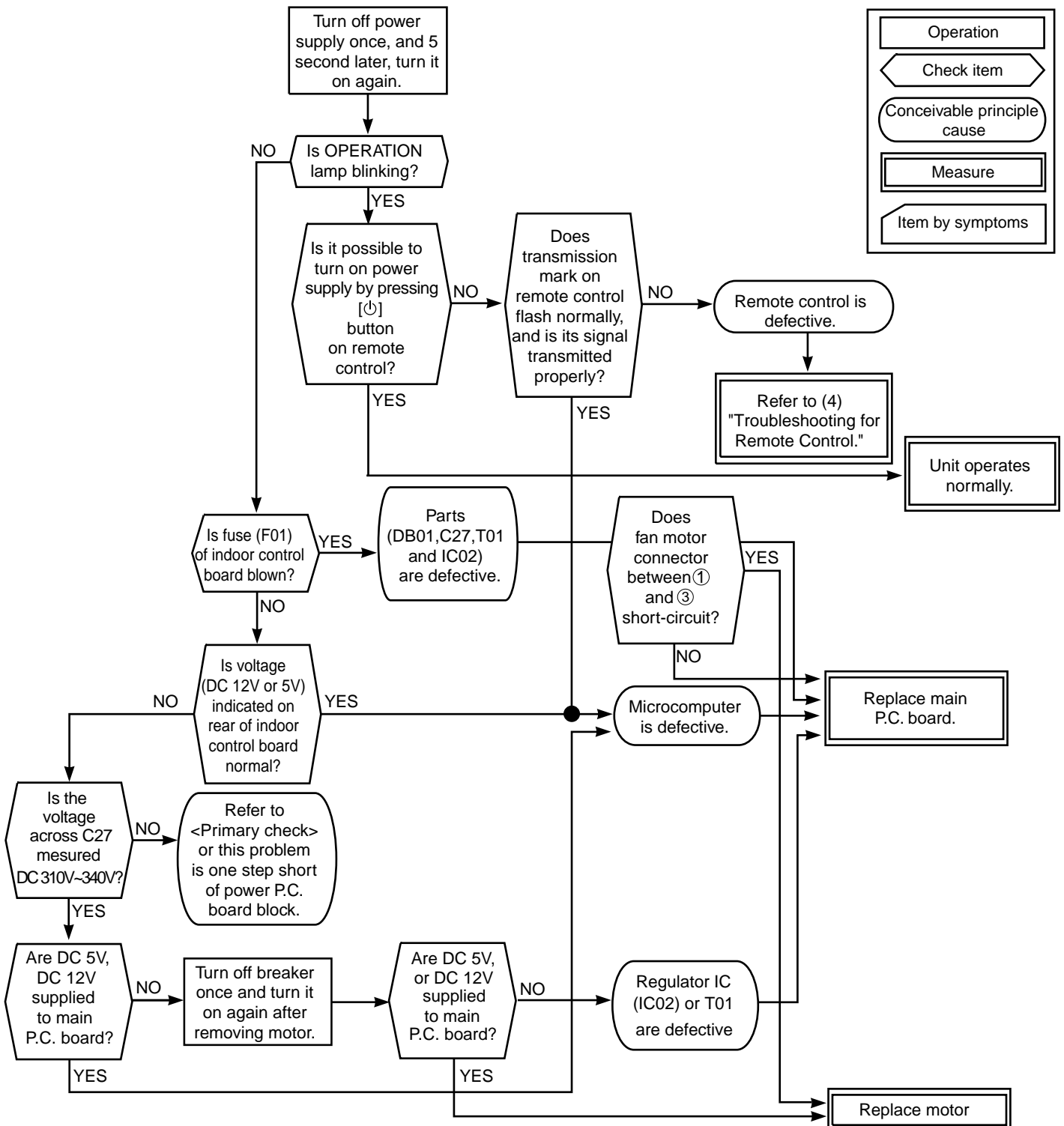

• Be sure to disconnect the motor connector CN31 after shut off the power supply, or it will be a cause of damage of the motor.

(2) Power is not turned on though Indoor P.C. board is replaced

<Confirmation procedure>

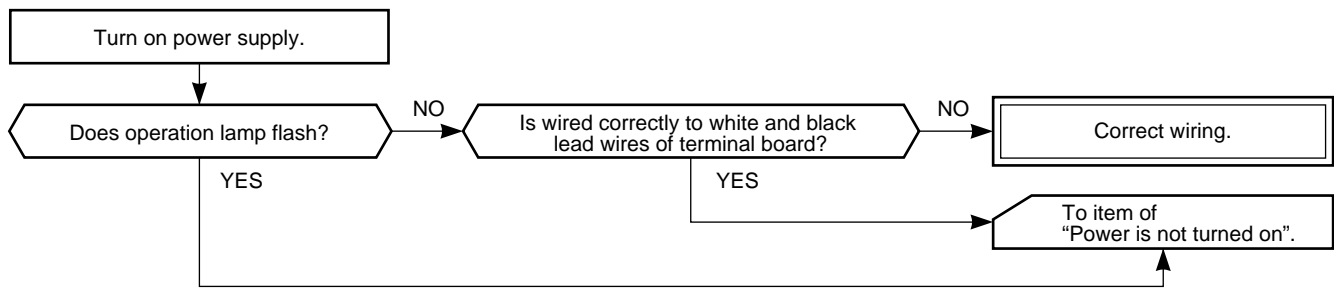

(3) Only the indoor motor fan does not operate

<Primary check>

1. Is it possible to detect the power supply voltage (AC220–240V) between ① and ② on the terminal block?
2. Does the indoor fan motor operate in cooling operation?
(In heating operation, the indoor fan motor does not operate for approximately 10 minutes after it is turned on, to prevent a cold air from blowing in.)

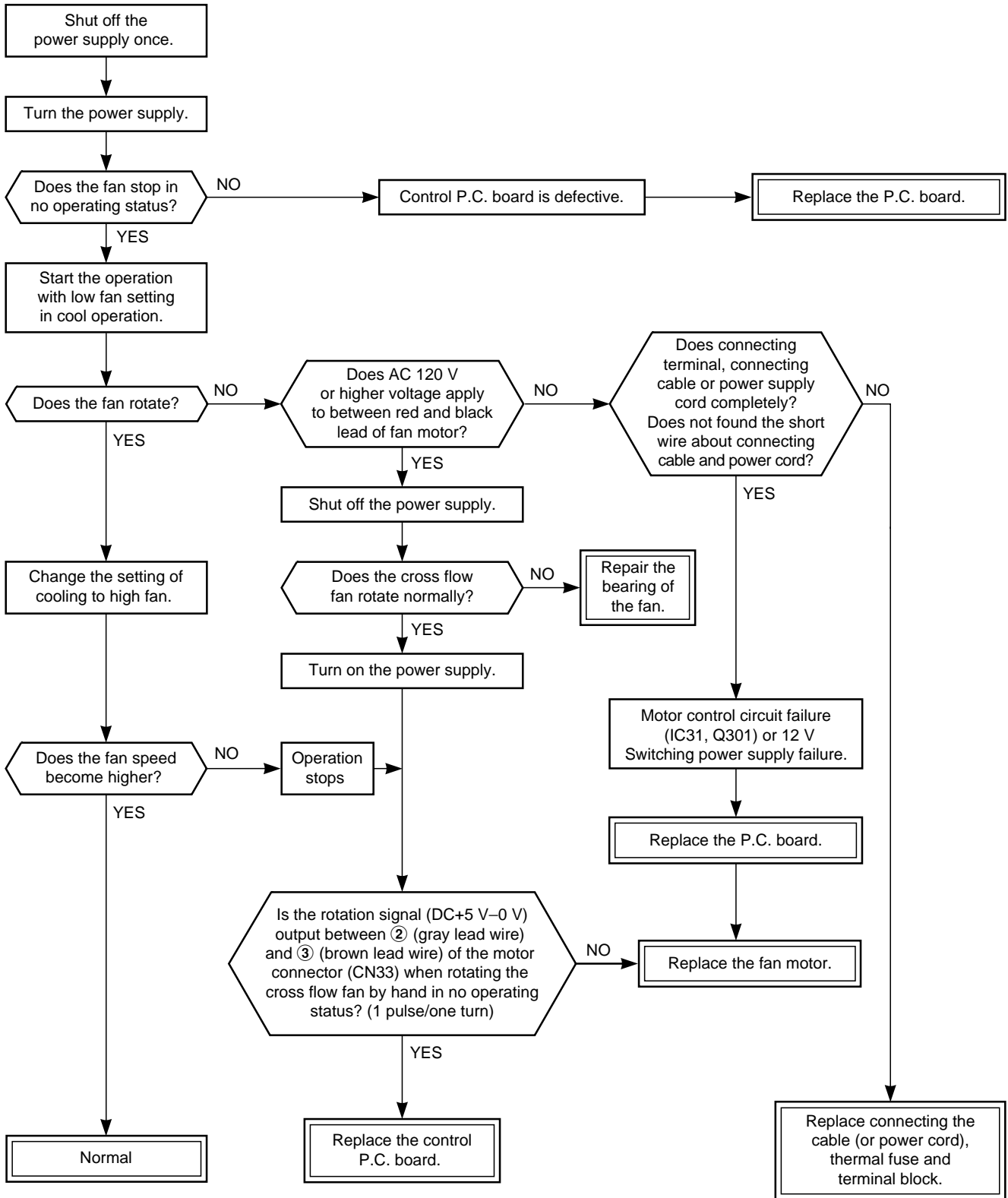

(For AC fan motor)

<Inspection procedure>

1. Remove the front panel. (Remove 2 screws.)
2. Remove the cover of the fan motor lead wires.
3. Check AC voltage with CN31 connector while the fan motor is rotating.

NOTE :

- Using a tester, measure the resistance value of each winding coil.
- Use a thin test rod.

AFN-220-20-4D

- Do not disconnect the connector while the fan motor is rotating.
- For P.C. board side, proceed to the item "Only indoor fan does not operate" of "Judgment of Trouble by Every Symptom".

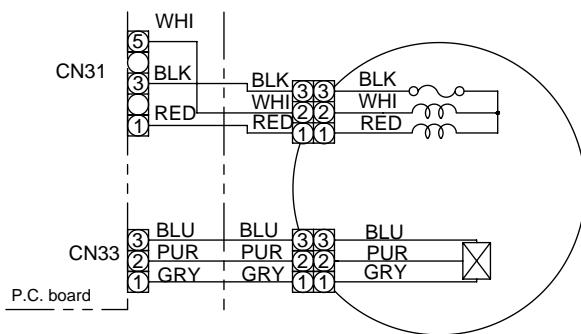

Position (P.C. board)	Resistance value
Between ③ (Black) - ① (Red)	249 ± 17 Ω
Between ③ (Black) - ⑤ (White)	373 ± 26 Ω
Between ① (Red) - ⑤ (White)	622 ± 44 Ω

(4) Troubleshooting for remote control

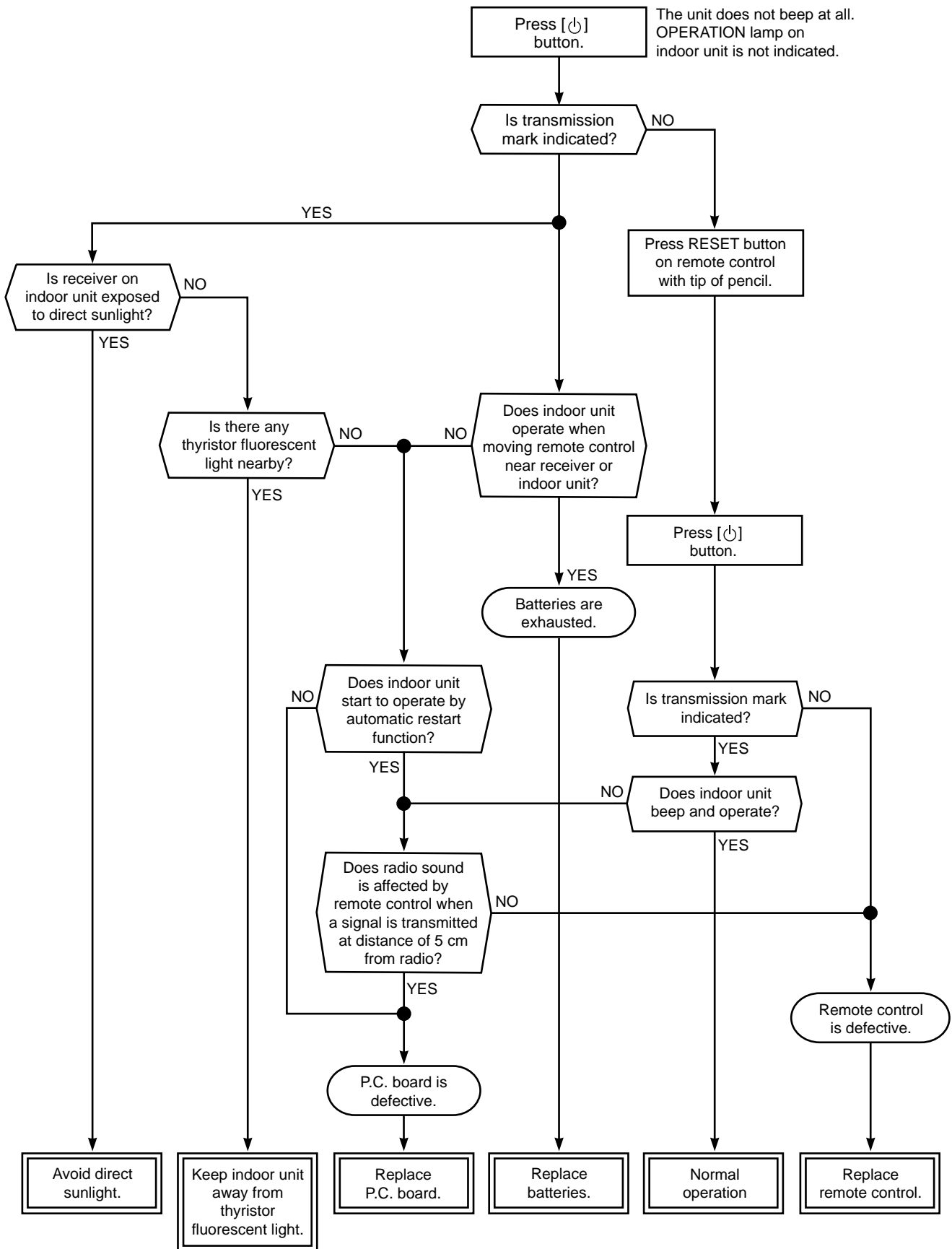

11-5-2. Wiring Failure (Interconnecting and Serial Signal Wire)

(1) Outdoor unit does not operate

1) Is the voltage between ② and ③ of the indoor terminal block varied?

Confirm that transmission from indoor unit to outdoor unit is correctly performed based upon the following diagram.

NOTE:

- Measurement should be performed 2 minutes and 30 seconds after starting of the operation.
- Be sure to prepare a diode for judgment.

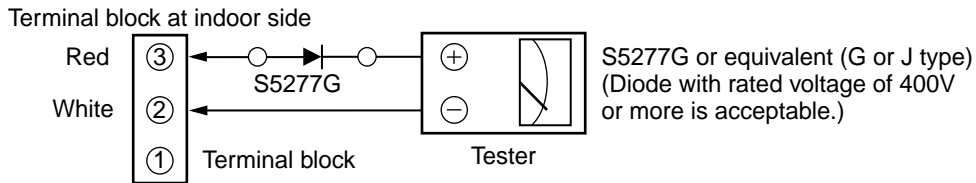

Normal time : Voltage swings between DC15 and 60V. Inverter Assembly check (11-7-1.)

Abnormal time : Voltage does not vary.

(2) Outdoor unit stops in a little while after operation started

<Check procedure> Select phenomena described below.

1) The outdoor unit stops 10 to 20 minutes after operation started, and 10 minutes or more are required to restart the unit.

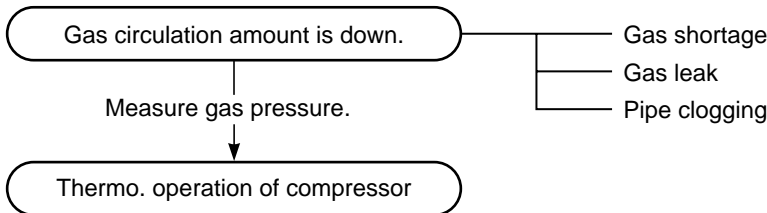

2) If the unit stops once, it does not operate until the power will be turned on again.

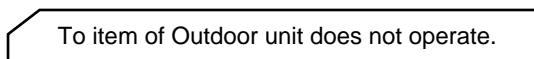

3) The outdoor unit stops 10 minutes to 1 hour after operation started, and an alarm is displayed. (Discharge temp. error check code 03, 1E Sensor temp. error check code 02, 1C)

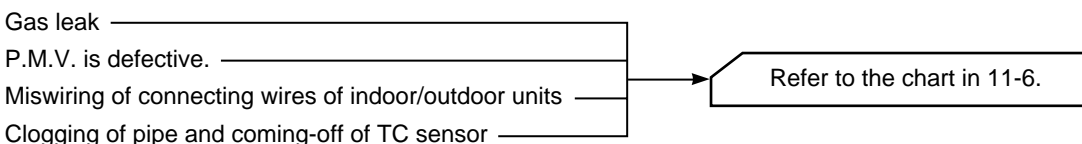

11-6. How to Check Simple the Main Parts

<Check procedure>

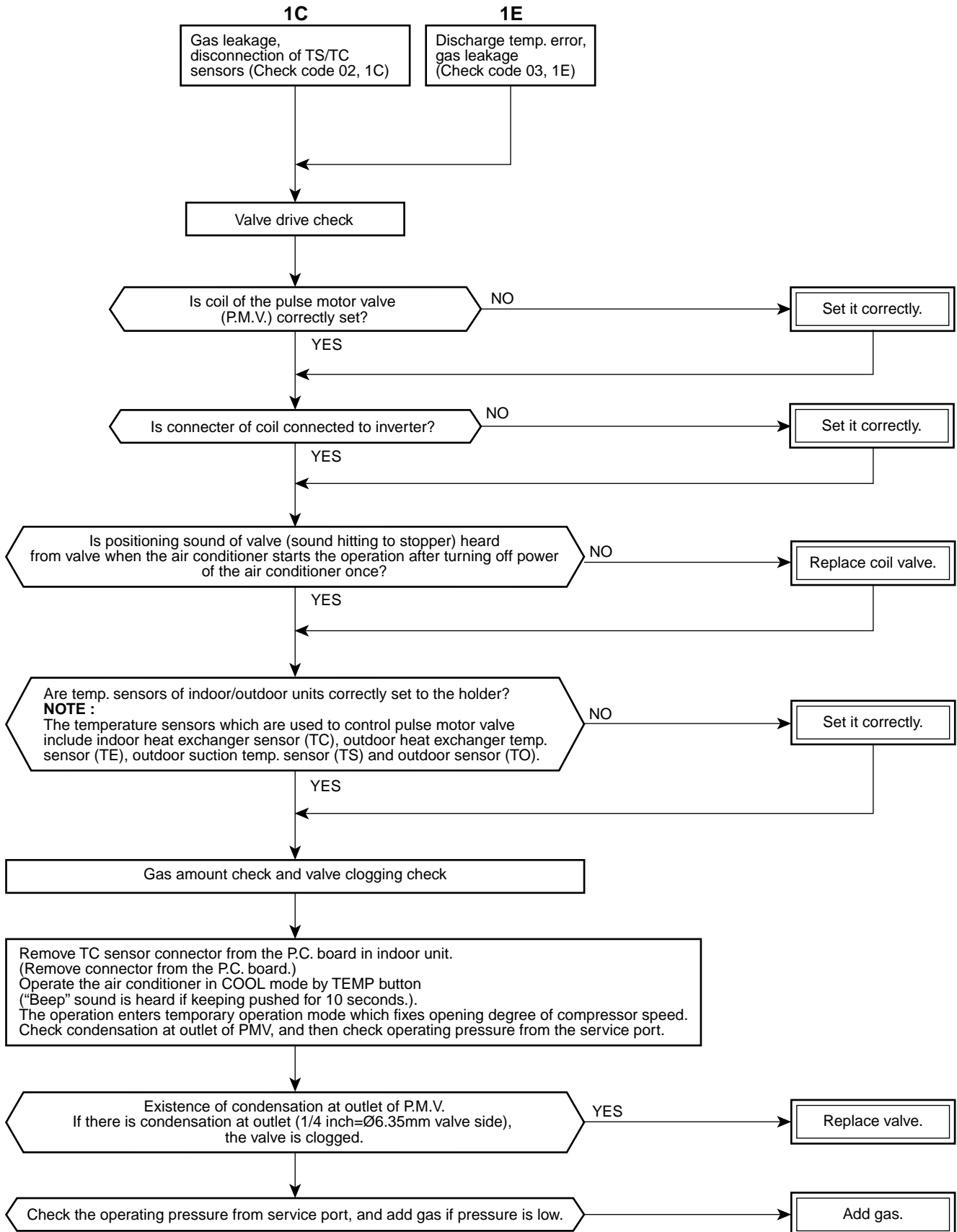

11-7. How to Diagnose Trouble in Outdoor Unit

11-7-1. Summarized Inner Diagnosis of Inverter Assembly

Table 11-7-1

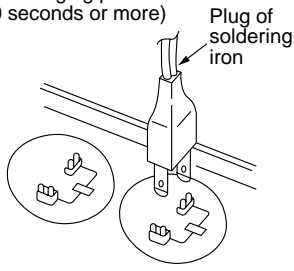
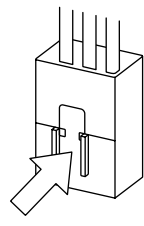
Diagnosis/Process flowchart	Item	Contents	Summary		
<pre> graph TD Start[Remove connector of compressor.] --> CheckFuse{{Check 25A fuse (Part No.F01).}} CheckFuse -- NG --> ReplaceFuse[Replace fuse.] ReplaceFuse --> CheckDB01{{Check electrolytic capacitor, diode block (DB01), etc.}} CheckDB01 -.-> CheckVoltage{{Check terminal voltage of electrolytic capacitor.}} CheckFuse -- OK --> CheckVoltage CheckVoltage -- NG --> CheckDB01 CheckVoltage -- OK --> FanRotate{{Does outdoor fan rotate?}} FanRotate -- YES --> A((A)) FanRotate -- NO --> CheckCN300{{Remove connector CN300 of outdoor fan motor, and using a tester, check resistance value between every phases at motor side.}} CheckCN300 -- NG --> ReplaceMotor[Replace outdoor fan motor.] CheckCN300 -- OK --> B((B)) </pre>	<p>Preparation</p> <p>Check</p> <p>Check</p> <p>Operation</p> <p>Measurement</p> <p>Check</p> <p>Stop</p> <p>Check Measurement</p>	<p>Turn "OFF" the power supply breaker, and remove 3P connector which connects inverter and compressor.</p> <ul style="list-style-type: none"> Check whether 25A fuse on the control board assembly is blown or not. (F01) <p>Turn on the power breaker, and operate the air conditioner in COOL mode by time shortening.</p> <p>Measure terminal voltage of the electrolytic capacity.</p> <table border="1" data-bbox="829 1545 1061 1624"> <tr> <td>500μF:400VV x 3</td> </tr> <tr> <td>760μF:400VV x 3</td> </tr> </table> <p>After operation, turn off the power breaker after 2 minutes 20 seconds passed, and discharge the electrolytic capacitor by soldering iron. Check voltage between motor phases.</p> <ul style="list-style-type: none"> Is not winding between ①-②, ②-③, or ①-③ opened or short-circuited? Is not frame grounded with ①, ②, or ③? 	500μF:400VV x 3	760μF:400VV x 3	<p>If fuse was blown, be sure to check the electrolytic capacitor and diode block. (DB01)</p> <ul style="list-style-type: none"> Connect discharge resistance (approx. 100Ω, 40W) or soldering iron (plug) between +, - terminals of the electrolytic capacitor (500μF or 760μF) of C14 (with printed CAUTION HIGH VOLTAGE) on P.C. board. <p>Discharging position (Discharging period 10 seconds or more)</p>  <p>OK if 500μF or 760μF → DC280 to 380V</p> <p>Remove CN300 while pushing the part indicated by an arrow because CN300 is a connector with lock.</p>  <p>→ Resistance between phases should be approx. 55 to 77Ω</p> <p>→ Should be 10MΩ or more.</p>
500μF:400VV x 3					
760μF:400VV x 3					

(3) Check procedures

Table 11-8-1

No.	Procedure	Check points	Causes
1	Turn off the power supply breaker and remove the P.C. board assembly from electronic parts base. Remove the connecting cables from the terminal block.	Check whether or not the fuse (F01) is blown.	Impulse voltage was applied or the indoor fan motor short-circuited.
2	Remove the connector of the motor and turn on the power supply breaker. If OPERATION indicator flashes (once per second), it is not necessary to check steps (1 to 3) in the right next column.	Check power supply voltage : 1. Between No. 1 and No. 3 of CN01 (AC 220–240V) 2. Between ⊕ and ⊖ of C27 (DC 310–340V) 3. Between 12V and GND 4. Between 5V and GND	1. The terminal block or the crossover cable is connected wrongly. 2. The capacitor (C01), line filter (L01), resistor (R64), or the diode (DB01) is defective. 3. T01 is defective. 4. IC02 and T01 are defective.
3	Push [⏻] button once to start the unit. (Do not set the mode to On-Timer operation.)	Check power supply voltage : 1. Between CN51 and No. 1 of CN01 (DC 15–60V)	IC51 and IC52 are defective.
4	Shorten the restart delay timer and start unit.	Check whether or not all indicators (OPERATION, TIMER, FILTER, PRE.DEF, Hi POWER) are lit for 3 seconds and they return to normal 3 seconds later.	The indicators are defective or the housing assembly (CN21) is defective.
5	Push [⏻] button once to start the unit. • Shorten the restart delay timer. • Set the operation mode to COOL. • Set the fan speed level to AUTO. • Set the preset temperature much lower than the room temperature. (The unit (compressor) operates continuously in the above condition.)	1. Check whether or not the compressor operates. 2. Check whether or not the OPERATION indicator flashes.	1. The temperature of the indoor heat exchanger is extremely low. 2. The connection of the heat exchanger sensor is loose. (The connector is disconnected.) (CN62) 3. The heat exchanger sensor and the P.C. board are defective. (Refer to Table 11-4-1.) 4. The main P.C. board is defective.
6	If the above condition (No. 5) still continues, start the unit in the following condition. • Set the operation mode to HEAT. • Set the preset temperature much higher than room temperature.	1. Check whether or not the compressor operates. 2. Check whether or not the OPERATION indicator flashes.	1. The temperature of the indoor heat exchanger is extremely high. 2. The connection of the heat exchanger sensor short-circuited. (CN62) 3. The heat exchanger sensor and the P.C. board are defective. (Refer to Table 11-4-1.) 4. The main P.C. board is defective
7	Connect the motor connector to the motor and turn on the power supply. Start the unit the following condition. • Set the fan speed level to HIGH. (The unit (compressor) operates continuously in the above condition in No. 5.)	1. Check it is impossible to detect the voltage (AC120V or higher voltage) between red and black lead of the motor. 2. The motor does not operate or the fan motor does not rotate with high speed. (But it is possible to receive the signal from the remote controller.) 3. The motor rotates but vibrates strongly.	1. The indoor fan motor is defective. (Protected operation of P.C. board.) 2. The P.C. board is defective. 3. The connection of the motor connector is loose.

11-8-2. P.C . Board Layout

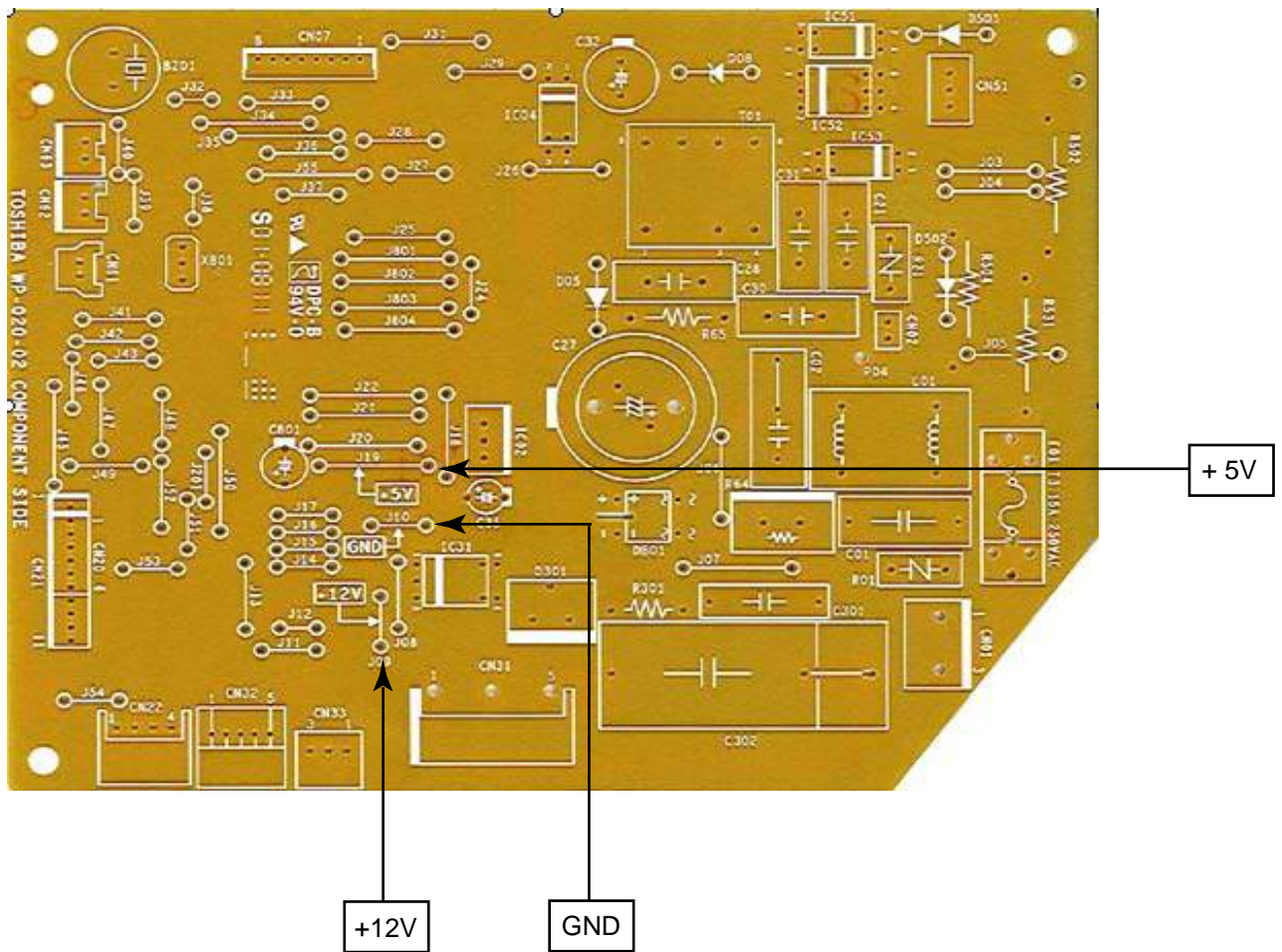

[1] Sensor characteristic table

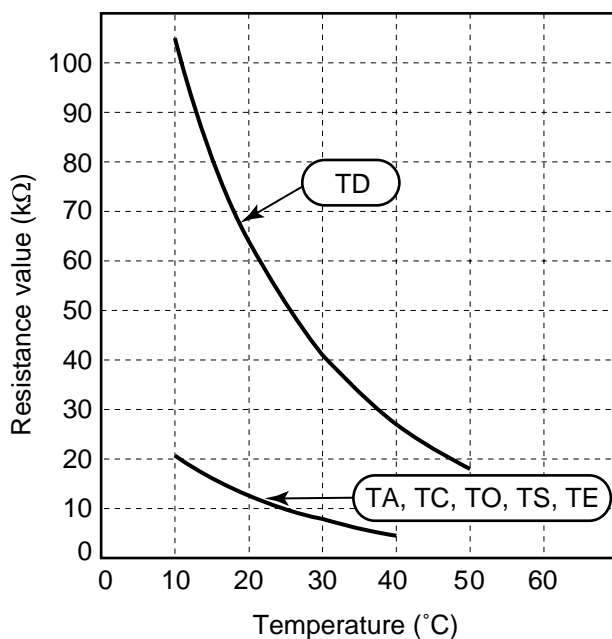

- TD : Discharge temp. sensor
- TA : Room temp. sensor
- TC : Heat exchanger temp. sensor
- TO : Outdoor temp. sensor
- TS : Suction temp. sensor
- TE : Outdoor heat exchanger temp sensor

11-8-3. Indoor Unit (Other Parts)

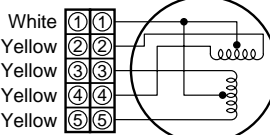
No.	Part name	Checking procedure																					
1	Room temp. (TA) sensor Heat exchanger (TC) sensor	<p>Disconnect the connector and measure the resistance value with tester. (Normal temp.)</p> <table border="1"> <thead> <tr> <th colspan="2">Temperature</th> <th>10°C</th> <th>20°C</th> <th>25°C</th> <th>30°C</th> <th>40°C</th> </tr> </thead> <tbody> <tr> <th>Sensor</th> <th></th> <td></td> <td></td> <td></td> <td></td> <td></td> </tr> <tr> <td></td> <td>TA, TC (kΩ)</td> <td>20.7</td> <td>12.6</td> <td>10.0</td> <td>7.9</td> <td>4.5</td> </tr> </tbody> </table>	Temperature		10°C	20°C	25°C	30°C	40°C	Sensor								TA, TC (kΩ)	20.7	12.6	10.0	7.9	4.5
Temperature		10°C	20°C	25°C	30°C	40°C																	
Sensor																							
	TA, TC (kΩ)	20.7	12.6	10.0	7.9	4.5																	
2	Remote controller	Refer to 11-5-1. (5).																					
3	Louver motor MSBPC20F04	<p>Measure the resistance value of each winding coil by using the tester. (Under normal temp. 25°C)</p>  <table border="1"> <thead> <tr> <th>Position</th> <th>Resistance value</th> </tr> </thead> <tbody> <tr> <td>1 to 2</td> <td rowspan="4">250Ω ± 7%</td> </tr> <tr> <td>1 to 3</td> </tr> <tr> <td>1 to 4</td> </tr> <tr> <td>1 to 5</td> </tr> </tbody> </table>	Position	Resistance value	1 to 2	250Ω ± 7%	1 to 3	1 to 4	1 to 5														
Position	Resistance value																						
1 to 2	250Ω ± 7%																						
1 to 3																							
1 to 4																							
1 to 5																							
4	Indoor fan motor	Refer to 11-5-1. (3) and (4).																					

11-8-4. Outdoor Unit

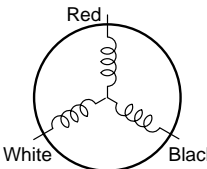
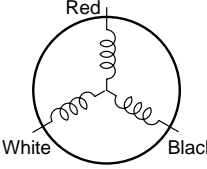
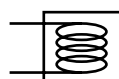
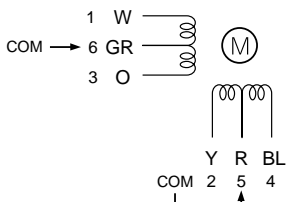
No.	Part name	Checking procedure																																
1	Compressor (Model : DA89X1C-23FZ2)	<p>Measure the resistance value of each winding by using the tester.</p>  <table border="1"> <thead> <tr> <th rowspan="2">Position</th> <th>Resistance value</th> </tr> </thead> <tbody> <tr> <td>DA89X1C-1F-23FZ</td> </tr> <tr> <td>Red - White</td> <td rowspan="3">1.04 to 1.16Ω</td> </tr> <tr> <td>White - Black</td> </tr> <tr> <td>Black - Red</td> </tr> </tbody> </table> <p style="text-align: right;">Under 20°C</p>	Position	Resistance value	DA89X1C-1F-23FZ	Red - White	1.04 to 1.16Ω	White - Black	Black - Red																									
Position	Resistance value																																	
	DA89X1C-1F-23FZ																																	
Red - White	1.04 to 1.16Ω																																	
White - Black																																		
Black - Red																																		
2	Outdoor fan motor (Model : ICF-140-43-4R)	<p>Measure the resistance value of winding by using the tester.</p>  <table border="1"> <thead> <tr> <th>Position</th> <th>Resistance value</th> </tr> </thead> <tbody> <tr> <td>Red - White</td> <td>20 to 22Ω</td> </tr> <tr> <td>White - Black</td> <td>20 to 22Ω</td> </tr> <tr> <td>Black- Red</td> <td>20 to 22Ω</td> </tr> </tbody> </table>	Position	Resistance value	Red - White	20 to 22Ω	White - Black	20 to 22Ω	Black- Red	20 to 22Ω																								
Position	Resistance value																																	
Red - White	20 to 22Ω																																	
White - Black	20 to 22Ω																																	
Black- Red	20 to 22Ω																																	
3	4-way valve coil (Model : STF)	<p>Measure the resistance value of winding by using the tester.</p>  <table border="1"> <thead> <tr> <th>Resistance value</th> </tr> </thead> <tbody> <tr> <td>1435 ± 144Ω</td> </tr> </tbody> </table> <p style="text-align: right;">Under 20°C</p>	Resistance value	1435 ± 144Ω																														
Resistance value																																		
1435 ± 144Ω																																		
4	Pulse motor valve coil (Model : CAM-MD12TCTH-2)	<p>Measure the resistance value of winding by using the tester.</p>  <table border="1"> <thead> <tr> <th>Position</th> <th>Resistance value</th> </tr> </thead> <tbody> <tr> <td>Gray - White</td> <td>43 to 49Ω</td> </tr> <tr> <td>Gray - Orange</td> <td>43 to 49Ω</td> </tr> <tr> <td>Red- Yellow</td> <td>43 to 49Ω</td> </tr> <tr> <td>Red- Blue</td> <td>43 to 49Ω</td> </tr> </tbody> </table> <p style="text-align: right;">Under 20°C</p>	Position	Resistance value	Gray - White	43 to 49Ω	Gray - Orange	43 to 49Ω	Red- Yellow	43 to 49Ω	Red- Blue	43 to 49Ω																						
Position	Resistance value																																	
Gray - White	43 to 49Ω																																	
Gray - Orange	43 to 49Ω																																	
Red- Yellow	43 to 49Ω																																	
Red- Blue	43 to 49Ω																																	
5	Outdoor temperature sensor (TO), discharge temperature sensor (TD), suction temperature sensor (TS), outdoor heat exchanger temperature sensor (TE)	<p>Disconnect the connector, and measure resistance value with the tester. (Normal temperature)</p> <table border="1"> <thead> <tr> <th colspan="2">Temperature</th> <th>10°C</th> <th>20°C</th> <th>25°C</th> <th>30°C</th> <th>40°C</th> <th>50°C</th> </tr> </thead> <tbody> <tr> <th>Sensor</th> <th></th> <td></td> <td></td> <td></td> <td></td> <td></td> <td></td> </tr> <tr> <td></td> <td>TD (kΩ)</td> <td>100</td> <td>64</td> <td>50</td> <td>41</td> <td>27</td> <td>18</td> </tr> <tr> <td></td> <td>TO,TS,TE (kΩ)</td> <td>20.7</td> <td>12.6</td> <td>10.0</td> <td>7.9</td> <td>4.5</td> <td>—</td> </tr> </tbody> </table>	Temperature		10°C	20°C	25°C	30°C	40°C	50°C	Sensor									TD (kΩ)	100	64	50	41	27	18		TO,TS,TE (kΩ)	20.7	12.6	10.0	7.9	4.5	—
Temperature		10°C	20°C	25°C	30°C	40°C	50°C																											
Sensor																																		
	TD (kΩ)	100	64	50	41	27	18																											
	TO,TS,TE (kΩ)	20.7	12.6	10.0	7.9	4.5	—																											

11-8-5. Checking Method for Each Part

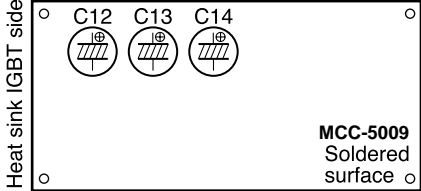
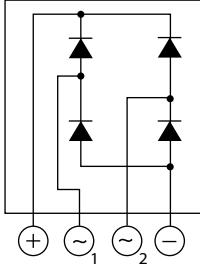
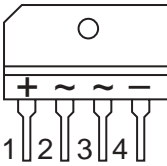
No.	Part name	Checking procedure															
1	Electrolytic capacitor (For raising pressure, smoothing)	<p>1. Turn OFF the power supply breaker. 2. Discharge all three capacitors completely. 3. Check that safety valve at the bottom of capacitor is not broken. 4. Check that vessel is not swollen or exploded. 5. Check that electrolytic liquid does not blow off. 6. Check that the normal charging characteristics are show in continuity test by the tester.</p> <div style="display: flex; justify-content: space-between; align-items: flex-start;"> <div style="border: 1px solid black; padding: 5px; width: 60%;">  </div> <div style="border: 1px solid black; padding: 5px; width: 35%;"> <p>Case that product is good</p> <p>Pointer swings once, and returns slowly. When performing test once again under another polarity, the pointer should return.</p> </div> </div> <p style="text-align: center;">C12, C13, C14 → 500μF/400V</p>															
2	Converter module	<p>1. Turn OFF the power supply breaker. 2. Discharge all three capacitors completely. 3. Check that the normal rectification characteristics are shown in continuity test by the tester.</p> <div style="display: flex; justify-content: space-around; align-items: center;">   </div> <p style="text-align: center;">(DB01)</p> <p style="text-align: center;">Diode check</p> <table border="1" style="margin-left: auto; margin-right: auto;"> <thead> <tr> <th colspan="2">Tester rod</th> <th>Resistance value in good product</th> </tr> </thead> <tbody> <tr> <td>⊕</td> <td>⊖</td> <td rowspan="4" style="text-align: center; vertical-align: middle;">50kΩ or more (0Ω in trouble)</td> </tr> <tr> <td>⊖₁</td> <td>⊖</td> </tr> <tr> <td>⊖₂</td> <td>⊖</td> </tr> <tr> <td>⊕</td> <td>⊖₁</td> </tr> <tr> <td>⊕</td> <td>⊖₂</td> <td></td> </tr> </tbody> </table>	Tester rod		Resistance value in good product	⊕	⊖	50kΩ or more (0Ω in trouble)	⊖ ₁	⊖	⊖ ₂	⊖	⊕	⊖ ₁	⊕	⊖ ₂	
Tester rod		Resistance value in good product															
⊕	⊖	50kΩ or more (0Ω in trouble)															
⊖ ₁	⊖																
⊖ ₂	⊖																
⊕	⊖ ₁																
⊕	⊖ ₂																

11-9. How to Simply Judge Whether Outdoor Fan Motor is Good or Bad

1. Symptom

- Outdoor fan motor does not rotate.
 - Outdoor fan motor stops within several tens seconds though it started rotating.
 - Outdoor fan motor rotates or does not rotate according to the position where the fan stopped, etc.
- Remote controller check code “02 : Outdoor block, 1A : Outdoor fan drive system error”

2. Cause

The following causes are considered when the outdoor fan motor does not normally rotate.

- 1) Mechanical lock of the outdoor fan motor
- 2) Winding failure of the outdoor fan motor
- 3) Position-detect circuit failure inside of the outdoor fan motor
- 4) Motor drive circuit failure of the outdoor P.C. board

3. How to simply judge whether outdoor fan motor is good or bad

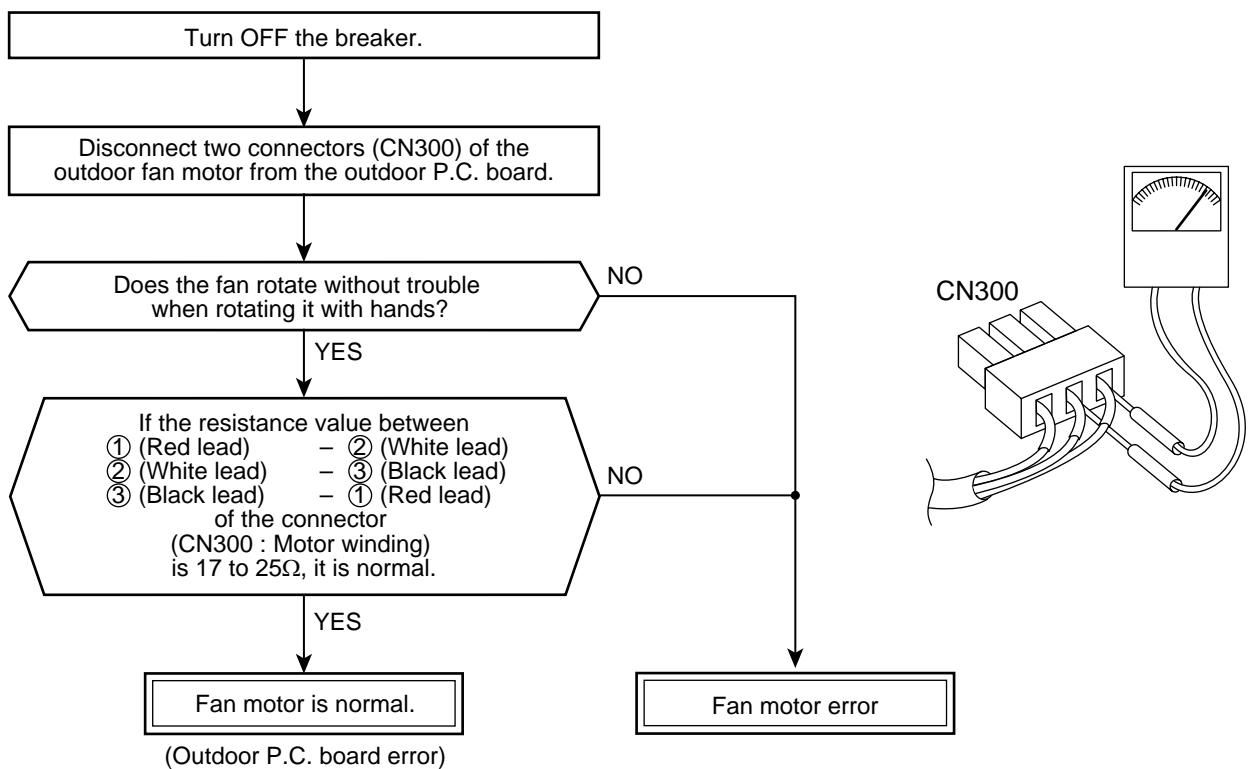

NOTE :

However, GND circuit error inside of the motor may be accepted in some cases when the above check is performed.

When the fan motor does not become normal even if P.C. board is replaced, replace the outdoor fan motor.

11-10. How to setting the CLEAN OPERATION cancel

- 1. Add J201 of indoor PC board assembly.
(If AUTO RESTART set before, will automatic cancel when add J201)

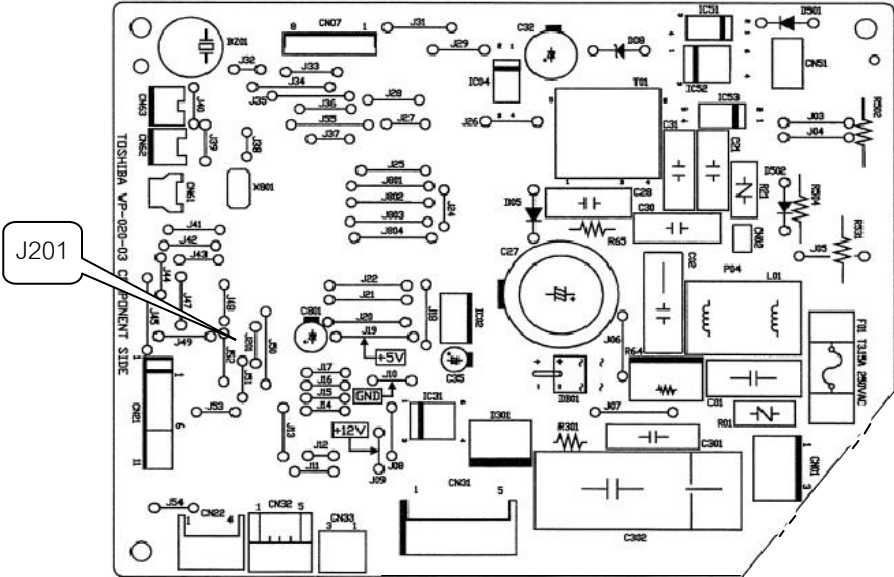

- 2. Turn ON breaker, then hold down the [RESET] button on the indoor unit for 3 seconds but not more than 10 seconds.
(The indoor unit 's buzzer will emits 3 beeps)

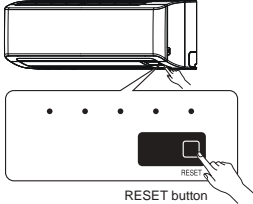

- 3. To operate a cooling mode for 20 minutes, then turn off by remote control to ensure that "Clean operation" is cancelled.
Remark If Auto restart still require, take off J201 when finish a "Clean operation cancelling" procedure.



12. HOW TO REPLACE THE MAIN PARTS

WARNING



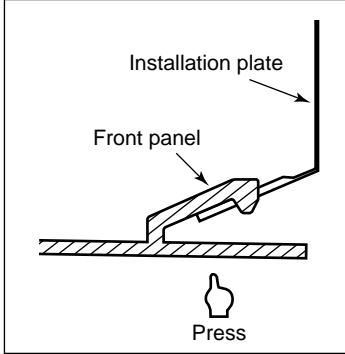

- Since high voltages pass through the electrical parts, turn off the power without fail before proceeding with the repairs.
Electric shocks may occur if the power plug is not disconnected.
- After the repairs have been completed (after the front panel and cabinet have been installed), perform a test run, and check for smoking, unusual sounds and other abnormalities.
If this check is omitted, a fire and/or electric shocks may occur.
Before proceeding with the test run, install the front panel and cabinet.
- Ensure that the following steps are taken when doing repairs on the refrigerating cycle.
 1. Do not allow any naked flames in the surrounding area.
If a gas stove or other appliance is being used, extinguish the flames before proceeding.
If the flames are not extinguished, they may ignite any oil mixed with the refrigerant gas.
 2. Do not use welding equipment in an airtight room.
Carbon monoxide poisoning may result if the room is not properly ventilated.
 3. Do not bring welding equipment near flammable objects.
Flames from the equipment may cause the flammable objects to catch fire.
- **If keeping the power on is absolutely unavoidable while doing a job such as inspecting the circuitry, wear rubber gloves to avoid contact with the live parts.**
Electric shocks may be received if the live parts are touched.
High-voltage circuits are contained inside this unit.
Proceed very carefully when conducting checks since directly touching the parts on the control circuit board may result in electric shocks.

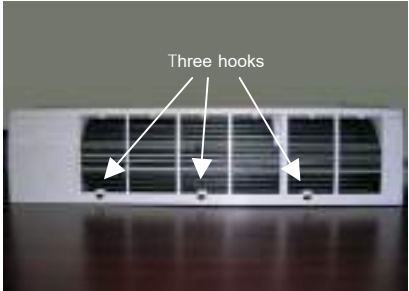
12-1. Indoor Unit

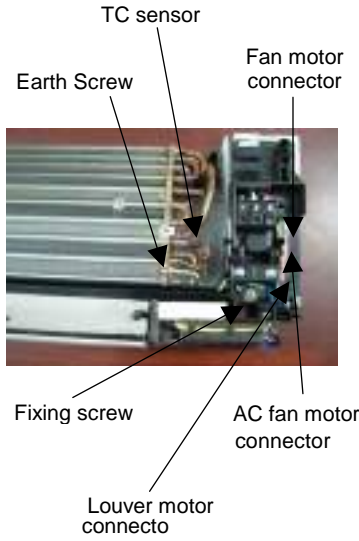
No.	Part name	Procedures	Remarks
①	Front panel	1) Stop operation of the air conditioner and turn off its main power supply. 2) Open the air inlet grille, push the arm toward the outside, and remove the grille. 3) Remove the left and right air filters.	

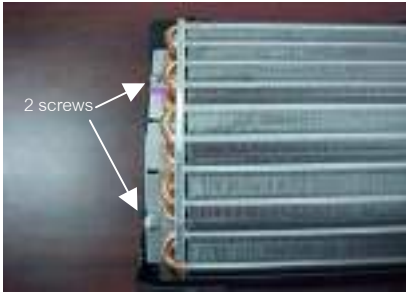
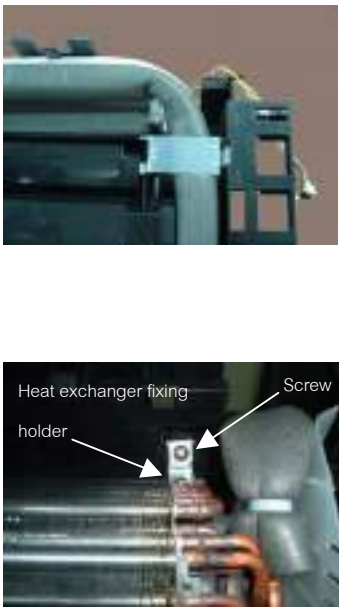
No.	Part name	Procedures	Remarks
①	Front panel	<p>4) Press "PUSH" part under the front panel and remove hooks of the front panel from the installation plate.</p> <p>5) Remove the front panel fixing screws. (2 pcs.)</p> <p>6) Take off three hooks of panel from rear side.</p> 	  
		<p><How to assemble the front panel></p> <p>1) Press three center positions and two lower center positions of the air outlet, and then hang the hanging hooks (3 pcs.) at the top side of the front panel to the rear plate.</p> <p>2) Tighten two screws.</p> <ul style="list-style-type: none"> • Incomplete hanging or incomplete pressing may cause a dewdrops or generation of a fluttering sound. 	

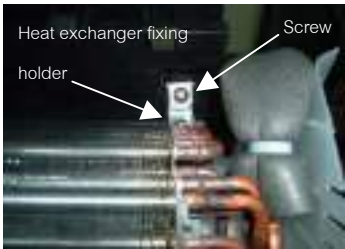
No.	Part name	Procedures	Remarks
②	Electric parts box assembly	<p>1) Follow the procedure up to 3) in ② above.</p> <p>2) Remove screw of earth lead attached to the end plate of the evaporator.</p> <p>3) Remove the lead wire cover, and remove connector for the fan motor and connector for the louver motor from the electric parts box assembly.</p> <p>4) Pull out TC sensor from sensor holder of the evaporator.</p> <p>5) Disengage the display unit by simply pushing at the top of the display unit.</p> <p>6) Remove the fixing screw that secures the electric parts box assembly, and remove the assembly.</p> <p><How to assemble the electric parts box></p> <p>1) Hook the top part of the electric parts box assembly onto the claws on the back body,</p> <p>Now attach the display unit. Connect the connectors for the fan motor and louver motor.</p> <p>2) Secure the grounding wire using the fixing screw. Insert the TC sensor into the sensor holder.</p> <p>* Be absolutely sure to loop the grounding wire and TC sensor leads once at the bottom.</p>	 <p>Electric part box cover</p> 

No.	Part name	Procedures	Remarks
③	Horizontal louver	1) Remove shaft of the horizontal louver from the back body. (First remove the left shaft, and then remove other shafts while sliding the horizontal louver leftward.)	
④	Evaporator (Heat exchanger)	1) Follow to the procedure in the item ③. 2) Remove the pipe holder from the rear side of the main unit. 3) Remove two fixing screws at the left side of the end plate of the heat exchanger.  4) Remove one fixing screw on the heat exchange fixing holder to separate the heat exchange from the back body.  5) Remove right side of the end plate from two fixing rib while sliding slightly the heat exchanger rightward. 	  

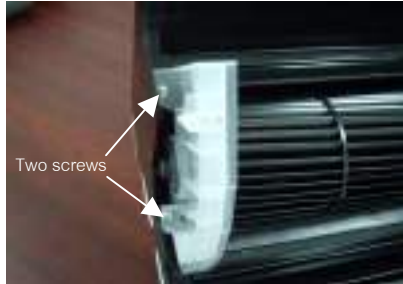
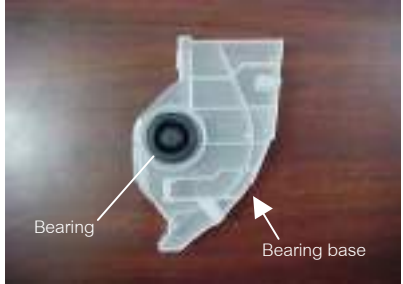
No.	Part name	Procedures	Remarks
⑤	Bearing	<p>1) Follow to the procedure in the item ④ .</p> <p>2) Remove the two screws used to secure the bearing base.</p> <p>3) Remove the bearing base.</p> <p><Caution at assembling></p> <ul style="list-style-type: none"> • If the bearing is out from the housing, push it into the specified position and then incorporate it in the main body. 	 <p>Two screws</p>  <p>Bearing</p> <p>Bearing base</p>

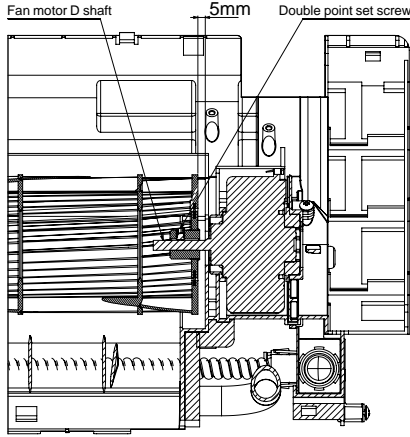
No.	Part name	Procedures	Remarks
⑦	Cross flow fan	<p><Caution at reassembling></p> <p>1) To incorporate the fan motor incorporate the motor into the position in the following figure, and then install the fan motor.</p> <ul style="list-style-type: none"> • Install the cross flow fan so that the right end of the 1st joint from the right of the cross flow fan is set keeping 5.0 mm from closed wall of the main unit. • Holding the set screw, install the cross flow fan so that flat area on shaft of the fan motor comes to the mounting hole of the set screw. • Perform positioning of the fan motor as follows: • When assembling the fan motor, the fan motor must be installed in such a way that the fan motor leads will be taken out is positioned at the bottom front. • After assembling the two hooking claws of the motor band (right) into the main body, position the fan motor, insert it, and then secure the motor band (right) using the two fixing screws. 	

12-2. Microcomputer

No.	Part name	Procedure	Remarks
①	Common procedure	1) Turn the power supply off to stop the operation of air-conditioner. 2) Remove the front panel. • Remove the 2 fixing screws. 3) Remove the electrical part base.	Replace terminal block, microcomputer ass'y and the P.C. board ass'y.

12-3. Outdoor Unit

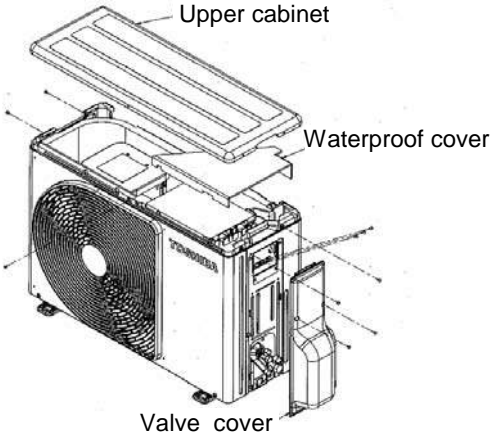
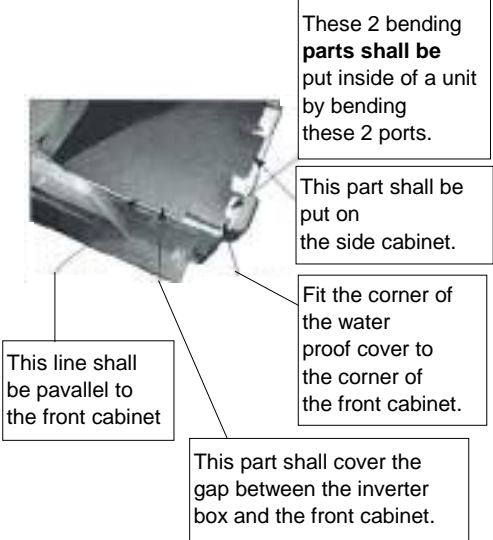
No.	Part name	Procedure	Remarks
①	Common procedure	<p>1. Detachment</p> <div style="border: 1px solid black; padding: 5px; margin: 10px 0;"> <p style="text-align: center;">NOTE</p> <p>Wear gloves for this job. Otherwise, you may injure your hands on the parts, etc.</p> </div> <ol style="list-style-type: none"> 1) Stop operation of the air conditioner, and turn off the main switch of the breaker for air conditioner. 2) Remove the valve cover. (ST1TØ4 x 10L 3 pcs.) <ul style="list-style-type: none"> • After removing screw, remove the valve cover pulling it downward. 3) Remove cord clamp (ST2TØ4 x 14L 3 pcs.), and then remove connecting cable. 4) Remove the upper cabinet. (ST1TØ4 x 10L 5 pcs.) <ul style="list-style-type: none"> • After removing screws, remove the upper cabinet pulling it upward. <p>2. Attachment</p> <ol style="list-style-type: none"> 1) Attach the water-proof cover. <div style="border: 1px solid black; padding: 5px; margin: 10px 0;"> <p style="text-align: center;">NOTE</p> <p>The water-proof cover must be attached without fail in order to prevent rain water, etc. from entering inside the indoor unit.</p> </div> <ol style="list-style-type: none"> 2) Attach the upper cabinet. (ST1TØ4 x 10L 5 pcs.) 3) Perform cabling of connecting cable, and attach the cord clamp. <ul style="list-style-type: none"> • Fix the cord clamp by tightening the screws (ST2TØ 4 x 14L 3 pcs.), fitting 2 concave parts of the cord clamp to each connecting cables. 4) Attach the valve cover. (ST1TØ 4 x 10L 3 pcs.) <ul style="list-style-type: none"> • Insert the upper part into the square hole of the side cabinet, set hook claws of the valve cover to square holes (at three positions) of the main unit, and attach it pushing upward, 	  <div style="border: 1px solid black; padding: 5px; margin: 10px 0; text-align: center;"> <p>How to mount the water-proof cover</p> </div>

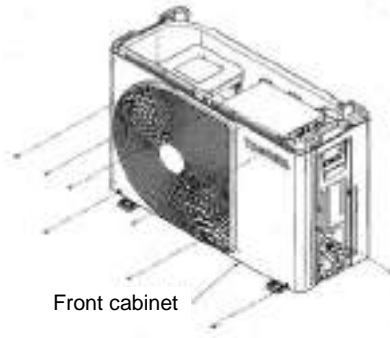
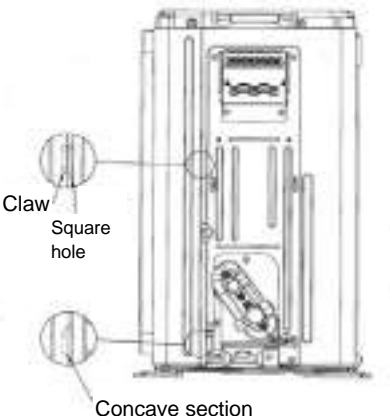
No.	Part name	Procedure	Remarks
②	Front cabinet	<p>1. Detachment</p> <ol style="list-style-type: none"> 1) Perform step 1 in ①. 2) Remove the fixing screws (ST1TØ4 × 10L 2 pcs.) used to secure the front cabinet and inverter cover, the screws (ST1TØ4 × 10L 4 pcs.) used to secure the front cabinet at the bottom, and the fixing screws (ST1TØ4 × 10L 2 pcs.) used to secure the motor base. <ul style="list-style-type: none"> • The front cabinet is fitted into the side cabinet (left) at the front left side so pull up the top of the front cabinet to remove it. <p>2. Attachment</p> <ol style="list-style-type: none"> 1) Insert the claw on the front left side into the side cabinet (left). 2) Hook the bottom part of the front right side onto the concave section of the bottom plate. Insert the claw of the side cabinet (right) into the square hole in the front cabinet. 3) Return the screws that were removed above to their original positions and attach them. 	 <p>Front cabinet</p>  <p>Claw Square hole Concave section</p>

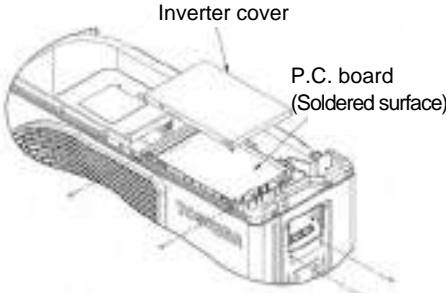
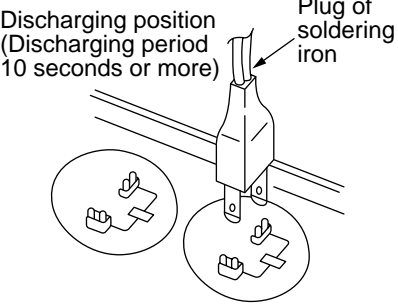
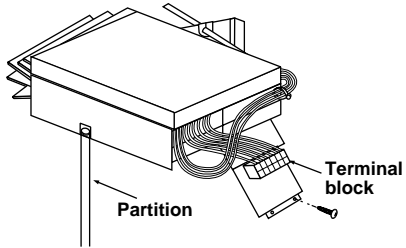
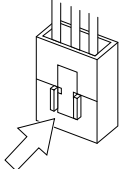
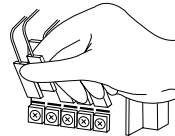

No.	Part name	Procedure	Remarks
③	Inverter assembly	<p>1) Perform work of item 1 in ①.</p> <p>2) Remove screw (ST1TØ4 x 10L 2 pcs.) of the upper part of the front cabinet.</p> <ul style="list-style-type: none"> • If removing the inverter cover in this condition, P.C. board can be checked. • If there is no space above the unit, perform work of 1 in ②. <div style="border: 1px solid black; padding: 5px; margin: 10px 0;"> <p>Be careful to check the inverter because high-voltage circuit is incorporated in it.</p> </div> <p>3) Perform discharging by connecting ⊕, ⊖ polarity by discharging resistance (approx. 100Ω40W) or plug of soldering iron to ⊕, ⊖ terminals a of the C14 (printed "CAUTION HIGH VOLTAGE" is attached.) electrolytic capacitor (760μF or 500μF) on P.C. board.</p> <div style="border: 1px solid black; padding: 5px; margin: 10px 0;"> <p>Be careful to discharge the capacitor because the electrolytic capacitor cannot naturally discharge and voltage remains according to trouble type in some cases.</p> </div> <div style="text-align: center; margin: 10px 0;"> <p>NOTE</p> <p>This capacitor is one with mass capacity. Therefore, it is dangerous that a large spark generates if short-circuiting between ⊕, ⊖</p> </div> <p>4) Remove screw (ST1TØ4 x 10L 4pcs.) fixing the terminal part of inverter box to the main body.</p> <p>5) Remove the front cabinet by performing step 1 in ② , and remove the fixing screws (ST1TØ4 x 10L) for securing the main body and inverter box.</p> <p>6) Remove various lead wires from the holder at upper part of the inverter box.</p> <p>7) Pull the inverter box upward.</p> <p>8) Disconnect connectors of various lead wires.</p> <div style="border: 1px solid black; padding: 5px; margin: 10px 0;"> <p style="text-align: center;">Requirement</p> <p>As each connector has a lock mechanism, avoid to remove the connector by holding the lead wire, but by holding the connector.</p> </div>	 <p style="text-align: center;">Inverter cover</p> <p style="text-align: right;">P.C. board (Soldered surface)</p>  <p>Discharging position (Discharging period 10 seconds or more)</p> <p>Plug of soldering iron</p>  <p style="text-align: right;">Terminal block</p> <p style="text-align: center;">Partition</p> <p>The connector is one with lock, so remove it while pushing the part indicated by an arrow.</p>   <p>Be sure to remove the connector by holding the connector, not by pulling the lead wire.</p>

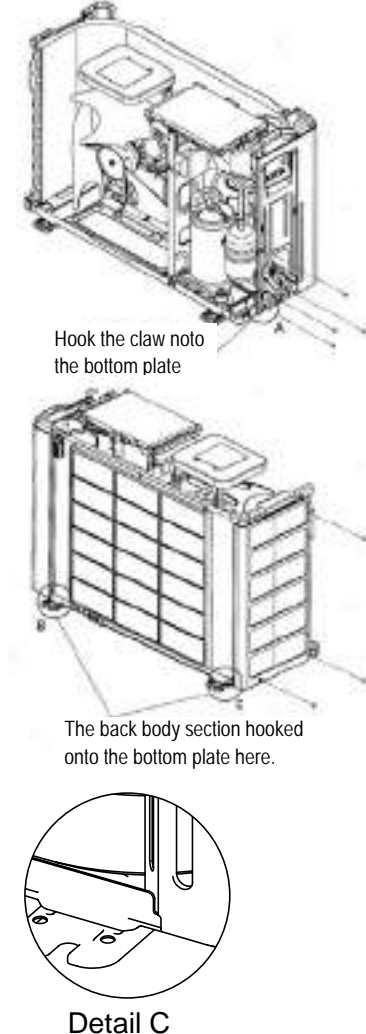
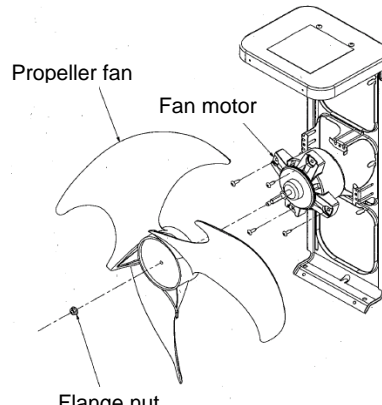
No.	Part name	Procedure	Remarks
④	Control board assembly	<p>1. Disconnect the leads and connectors connected to the other parts from the control board assembly.</p> <p>1) Leads</p> <ul style="list-style-type: none"> • 3 leads (black, white, orange) connected to terminal block. • Lead connected to compressor : Disconnect the connector (3P). • Lead connected to reactor : Disconnect the two connectors (2P). <p>2) Connectors (x8)</p> <p>CN300 : Outdoor fan motor (3P: white)* (* : See Note)</p> <p>CN701 : 4-way valve (2P: yellow)*</p> <p>CN600 : TE sensor (2P: white)*</p> <p>CN700 : PMV (6P: white)</p> <p>CN603 : TS sensor (3P: white)*</p> <p>CN601 : TD sensor (3P: white)*</p> <p>CN602 : TO sensor (2P: white)</p> <div data-bbox="424 898 1054 1043" style="border: 1px solid black; padding: 5px; margin: 10px 0;"> <p style="text-align: center;">NOTE</p> <p>These connectors have a disconnect prevention mechanism: as such, the lock on their housing must be released before they are disconnected.</p> </div> <p>2. Remove the control board assembly from the P.C. board base. (Remove the heat sink and control board assembly while keeping them screwed together.)</p> <div data-bbox="424 1211 1054 1335" style="border: 1px solid black; padding: 5px; margin: 10px 0;"> <p style="text-align: center;">NOTE</p> <p>Disengage the four claws of the P.C. board base, hold the heat sink, and lift to remove it.</p> </div> <p>3. Remove the two fixing screws used to secure the heat sink and control board assembly.</p> <p>4. Mount the new control board assembly.</p> <div data-bbox="424 1491 1054 1637" style="border: 1px solid black; padding: 5px; margin: 10px 0;"> <p style="text-align: center;">NOTE</p> <p>When mounting the new control board assembly, ensure that the P.C. board is inserted properly into the P.C. board support groove.</p> </div>	<div data-bbox="1102 315 1433 521" style="border: 1px solid black; padding: 5px; margin-bottom: 10px;"> </div> <p>CN300, CN701, CN600 and CN603 are connectors with locking mechanisms: as such, to disconnect them, they must be pressed in the direction of the arrow while pulling them out.</p> <div data-bbox="1198 891 1313 1081" style="text-align: center;"> </div> <div data-bbox="1219 1104 1278 1182" style="text-align: center;"> </div> <div data-bbox="1102 1223 1374 1346" style="text-align: center;"> <p>P.C. board base P.C. board</p> </div>

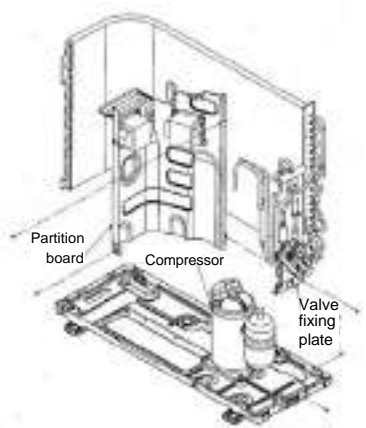
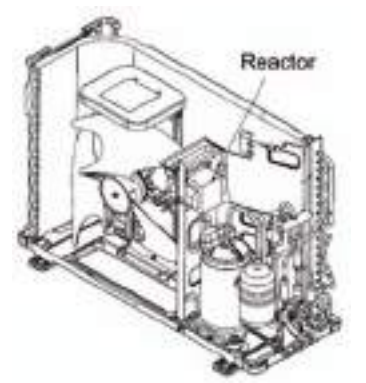
No.	Part name	Procedure	Remarks
⑤	Side cabinet	<p>1. Side cabinet (right)</p> <ol style="list-style-type: none"> 1) Perform step 1 in ② and all the steps in ③. 2) Remove the fixing screw (ST1TØ4 × 10L 4 pcs.) used for securing the side cabinet to the bottom plate and valve fixing panel. <p>2. Side cabinet (left)</p> <ol style="list-style-type: none"> 1) Perform step 1 in ②. 2) Remove the fixing screw (ST1TØ4 × 10L 1 pc.) used to secure the side cabinet (left) onto the heat exchanger. 3) Remove the fixing screw (ST1TØ4 × 10L 2 pcs.) used for securing the side cabinet to the bottom plate and heat exchanger. 	 <p>Hook the claw onto the bottom plate</p> <p>The back body section hooked onto the bottom plate here.</p> <p>Detail A Detail B Detail C</p>
⑥	Fan motor	<ol style="list-style-type: none"> 1) Perform work of item 1 of ① and ②. 2) Remove the flange nut fixing the fan motor and the propeller. <ul style="list-style-type: none"> • Flange nut is loosened by turning clockwise. (To tighten the flange nut, turn counterclockwise.) 3) Remove the propeller fan. 4) Disconnect the connector for fan motor from the inverter. 5) Remove the fixing screws (4 pcs.) holding by hands so that the fan motor does not fall. <p>* Precautions when assembling the fan motor Tighten the flange nut using a tightening torque of 4.9 N•m.</p>	 <p>Propeller fan</p> <p>Fan motor</p> <p>Flange nut</p>

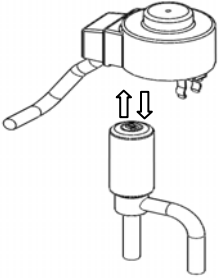
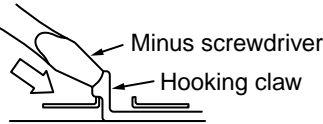
No.	Part name	Procedure	Remarks
⑦	Compressor	<ol style="list-style-type: none"> 1) Perform work of item 1 of ① and ②, ③, ④, ⑤. 2) Extract refrigerant gas. 3) Remove the partition board. (ST1TØ4 × 10L 3 pcs.) 4) Remove the sound-insulation material. 5) Remove terminal cover of the compressor, and disconnect lead wire of the compressor from the terminal. 6) Remove pipe connected to the compressor with a burner. <ul style="list-style-type: none"> • Take care to keep the 4-way valve away from naked flames. (Otherwise, it may malfunction.) 7) Remove the fixing screw of the bottom plate and heat exchanger. (ST1TØ4 × 10L 1 pc.) 8) Remove the fixing screw of the bottom plate and valve fixing plate. (ST1TØ4 × 10L 1 pc.) 9) Pull upward the refrigeration cycle. 10) Remove NUT (3 pcs.) fixing the compressor to the bottom plate. 	
⑧	Reactor	<ol style="list-style-type: none"> 1) Perform work of item 1 of ②, and ③. 2) Remove screws fixing the reactors. (ST1TØ4 × 10L 2 pcs.) 	

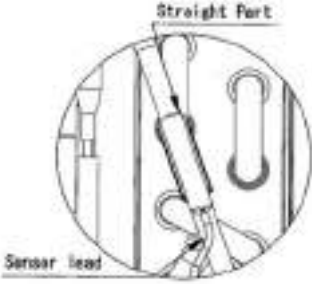
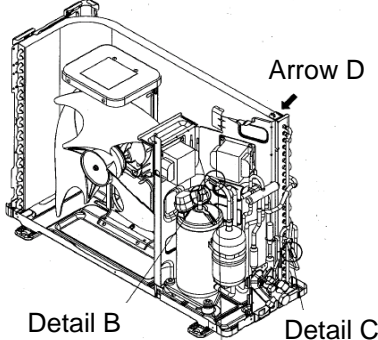
No.	Part name	Procedure	Remarks
⑨	Electronic expansion valve coil	<p>1. Detachment</p> <p>1) Perform step 1 in ②, all the steps in ③ and 1 in ⑤.</p> <p>2) Remove the coil by pull it upward.</p> <p>2. Attachment</p> <p>1) Insert a valve coil to value body by push it downward. And confirm to fix it surely.</p>	
⑩	Fan guard	<p>1. Detachment</p> <p>1) Perform work of item 1 of ②.</p> <p>2) Remove the front cabinet, and put it down so that fan guard side directs downward.</p> <div data-bbox="453 1093 1023 1189" style="border: 1px solid black; padding: 5px; margin: 10px 0;"> <p>Perform work on a corrugated cardboard, cloth, etc. to prevent flaw to the product.</p> </div> <p>3) Remove the hooking claws by pushing minus screwdriver according to the arrow mark in the right figure, and remove the fan guard.</p> <p>2. Attachment</p> <p>1) Insert claws of the fan guard in the holes of the front cabinet. Push the hooking claws (9 positions) by hands and fix the claws.</p> <div data-bbox="453 1547 1023 1644" style="border: 1px solid black; padding: 5px; margin: 10px 0;"> <p>Check that all the hooking claws are fixed to the specified positions.</p> </div>	

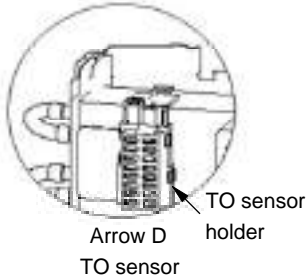
No.	Part name	Procedure	Remarks
⑪	<p>TE sensor (outdoor heat exchanging temperature sensor)</p> <p>• Attachment</p> <p>Install the sensor onto the straight pipe part of the condenser output pipe.</p>	 <p style="text-align: center;">Detail C</p>	 <ul style="list-style-type: none"> • Shown in the above figure is the model 16k. • The sensor mounting positions in the model 13k are all the same with the sole exception of the TE sensor. Refer to the figure shown on the left.
⑫	<p>TS sensor (Suction pipe temperature sensor)</p> <p>• Attachment</p> <p>Install the sensor onto the straight pipe part of the suction pipe. Be careful for the lead direction of the sensor.</p>		 <p style="text-align: center;">Detail A TS Sensor</p>
⑬	<p>TD sensor (Discharge pipe temperature sensor)</p> <p>• Attachment</p> <p>With its leads pointed upward, install the sensor onto the vertical straight pipe part of the discharge pipe.</p>		 <p style="text-align: center;">Detail B TD Sensor</p>
⑭	<p>TO sensor (Outside air temperature sensor)</p> <p>• Attachment</p> <p>Insert the outdoor air temperature sensor into the holder, and install the holder onto the heat exchanger.</p>		 <p style="text-align: center;">TO sensor holder TO sensor</p> <div style="border: 1px solid black; border-radius: 15px; padding: 10px; margin: 10px 0; text-align: center;"> <p>CAUTION</p> <p>During the installation work (and on its completion), take care not to damage the coverings of the sensor leads on the edges of the metal plates or other parts. It is dangerous for these coverings to be damaged since damage may cause electric shocks and/or a fire.</p> </div> <div style="border: 1px solid black; border-radius: 15px; padding: 10px; margin: 10px 0; text-align: center;"> <p>CAUTION</p> <p>After replacing the parts, check whether the positions where the sensors were installed are the proper positions as instructed. The product will not be controlled properly and trouble will result if the sensors have not been installed in their proper positions.</p> </div>

No.	Part name	Procedure	Remarks																												
⑮	<p>Replacement of temperature sensor for servicing only</p> <p>Common service parts of sensor TO, TS, TE, TD</p> <p>These are parts for servicing sensors. Please check that the accessories shown in the right table are packed.</p>	<ol style="list-style-type: none"> 1) Cut the sensor 100 mm longer than old one. 2) Cut the protective tube after pulling out it (200 mm). 3) Move the protective tube toward the thermal sensor side and tear the tip of lead wire in two then strip the covering part. 4) Pass the stripped part through the thermal constringent tube. 5) Cut the old sensor 100 mm length on the connector side, and recycle that connector. 6) Tear the lead wire in two on the connector side and strip the covering part. 7) Twist the leads on the connector and sensor sides, and solder them. 8) Move the thermal constringent tubes toward the soldered parts and heat them with the dryer and constring them. 9) Wind the attached color tape round the both terminals of the protective tube when colored protective tube is used. 10) Fix the sensor again. 																													
		<p>NOTE</p> <ol style="list-style-type: none"> 1) Store the joint part of the sensor and the connector in the electric parts box. 2) Never joint them near the thermal sensor part. Otherwise it would cause insulation inferiority because of dew drops. 3) When replacing the sensor using the colored protective tube, wind the color tape matching the color of that tube. 																													
		<table border="1" style="width: 100%; border-collapse: collapse;"> <thead> <tr> <th style="width: 5%;"></th> <th style="width: 60%;">Parts name</th> <th style="width: 10%;">Q'ty</th> <th style="width: 25%;">Remarks</th> </tr> </thead> <tbody> <tr> <td style="text-align: center;">1</td> <td>Sensor</td> <td style="text-align: center;">1</td> <td>Length : 3m</td> </tr> <tr> <td style="text-align: center;">2</td> <td>Sensor Spring (A)</td> <td style="text-align: center;">1</td> <td>For spare</td> </tr> <tr> <td style="text-align: center;">3</td> <td>Sensor Spring (B)</td> <td style="text-align: center;">1</td> <td>For spare</td> </tr> <tr> <td style="text-align: center;">4</td> <td>Thermal constringent tube</td> <td style="text-align: center;">3</td> <td>Including one spare</td> </tr> <tr> <td style="text-align: center;">5</td> <td>Color tape</td> <td style="text-align: center;">1</td> <td>9 colors</td> </tr> <tr> <td style="text-align: center;">6</td> <td>Terminal</td> <td style="text-align: center;">3</td> <td></td> </tr> </tbody> </table>			Parts name	Q'ty	Remarks	1	Sensor	1	Length : 3m	2	Sensor Spring (A)	1	For spare	3	Sensor Spring (B)	1	For spare	4	Thermal constringent tube	3	Including one spare	5	Color tape	1	9 colors	6	Terminal	3	
	Parts name	Q'ty	Remarks																												
1	Sensor	1	Length : 3m																												
2	Sensor Spring (A)	1	For spare																												
3	Sensor Spring (B)	1	For spare																												
4	Thermal constringent tube	3	Including one spare																												
5	Color tape	1	9 colors																												
6	Terminal	3																													

13. EXPLODED VIEWS AND PARTS LIST

13-1. Indoor Unit (Part-E)

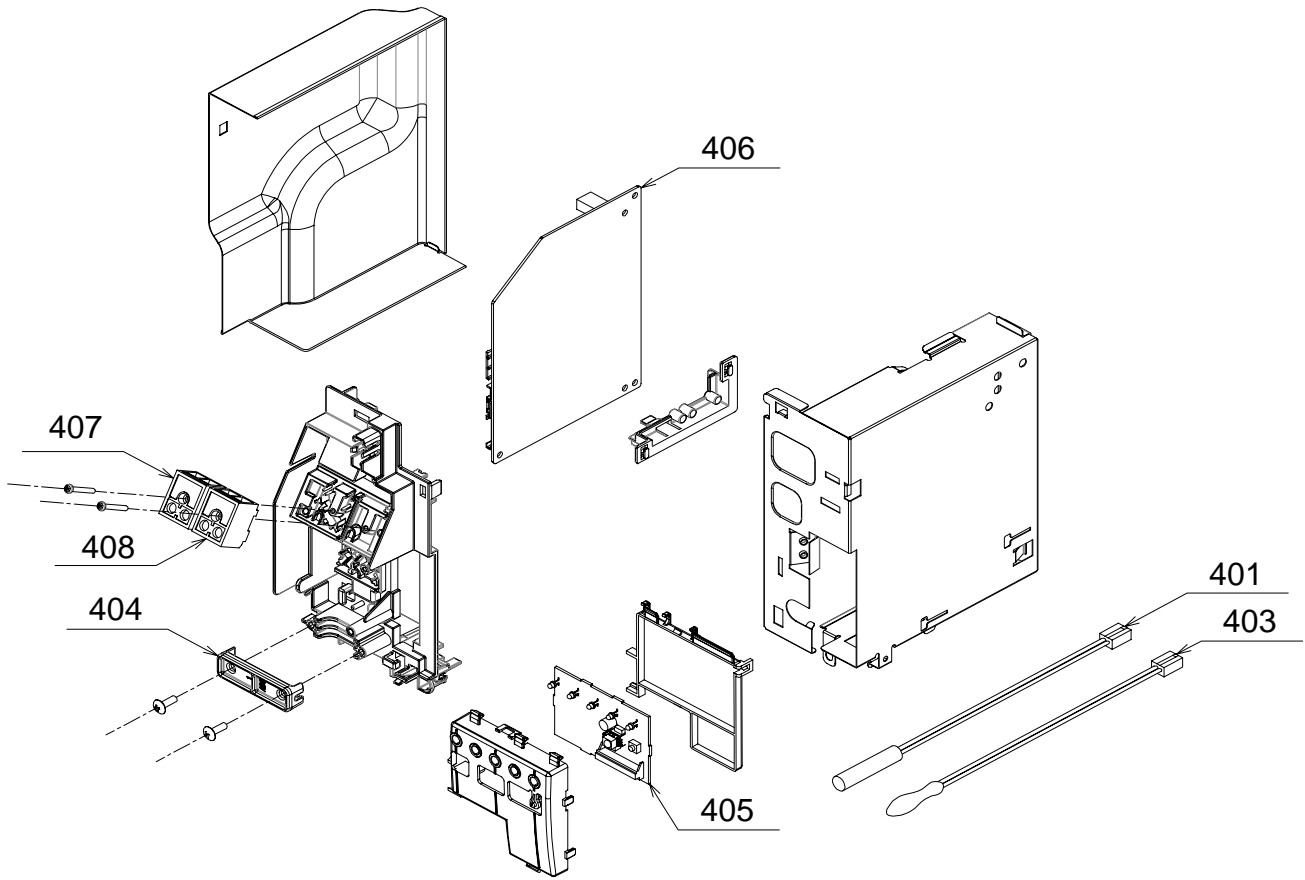

Location No.	Part No.	Description	Location No.	Part No.	Description
401	43T69319	TEMPERATURE SENSOR	406	43T6V334	PC BOARD
403	43T69320	TEMPERATURE SENSOR	407	43T60378	TERMINAL
404	43T62340	CORD-CLAMP	408	43T60417	TERMINAL
405	43T6V316	PC BOARD ASSY;WRS-LED			

13-2. Indoor Unit

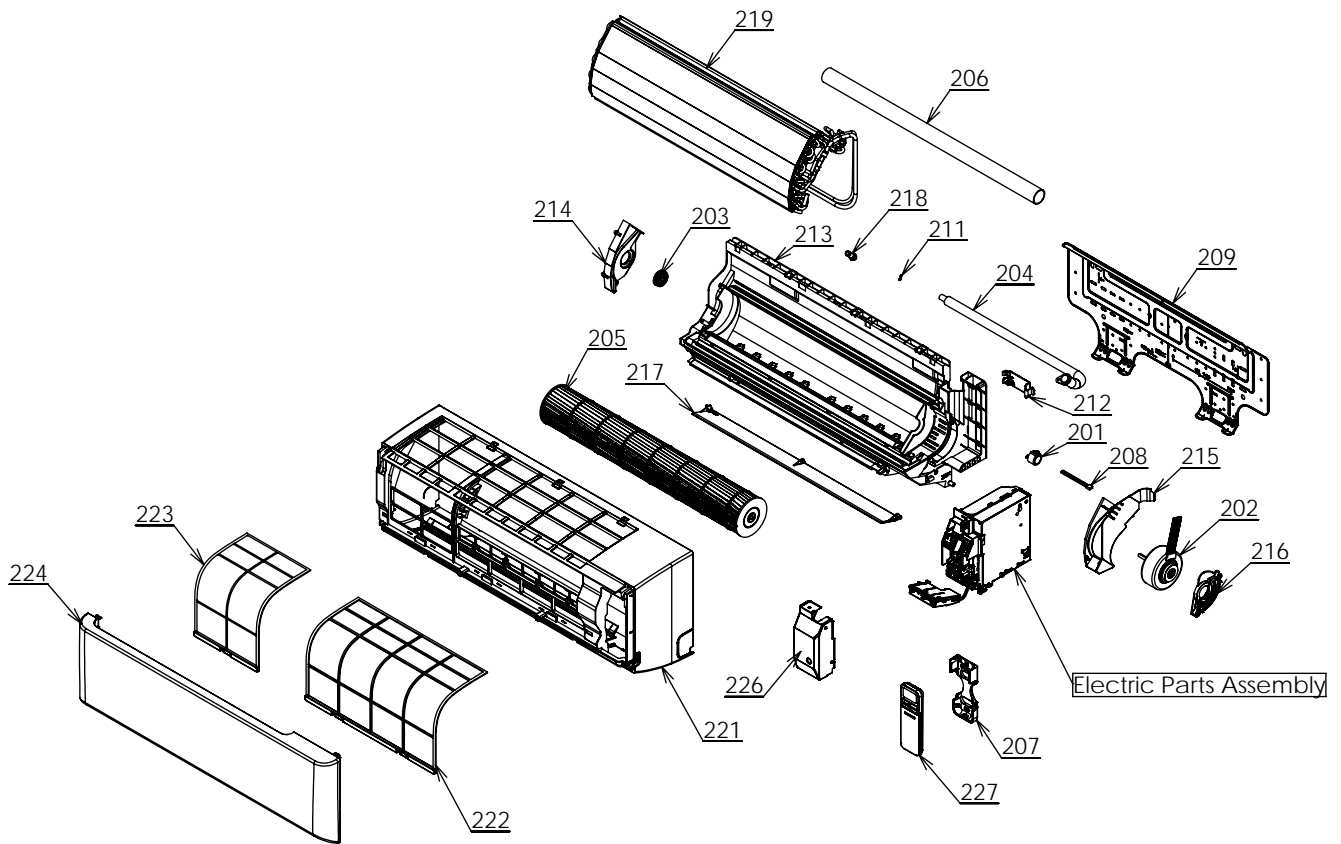

Location No.	Part No.	Description	Location No.	Part No.	Description
201	43T21435	STEPPING MOTOR ASSEMBLY	214	43T39327	BEARING BASE
202	43T21409	FAN MOTOR	215	43T39328	MOTOR BAND (LEFT)
203	43T22312	BEARING ASSY, MOLD	216	43T39329	MOTOR BAND (RIGHT)
204	43T70313	HOSE, DRAIN	217	43T09409	HORIZONTAL LOUVER
205	43T20325	CROSS FLOW FAN ASSEMBLY	218	43T79313	CAP, DRAIN
206	43T11301	PIPE SHIELD	219	43T44402	REFRIGERANT CYCLE ASSEMBLY
207	43T83003	HOLDER, REMOTE CONTROL	221	43T00587	PANEL SERVICE ASSEMBLY
208	43T60382	MOTOR CORD	222	43T80327	FILTER-AIR-R
209	43T82310	INSTALLATION PLATE	223	43T80328	FILTER-AIR-L
211	43T19333	HOLDER, SENSOR	224	43T09482	GRILLE OF AIR INLET
212	43T09408	PIPE HOLDER	226	43T62344	TERMINAL COVER ASSEMBLY
213	43T03360	BACK BODY ASSEMBLY	227	43T66315	WIRELESS REMOTE CONTROLLER

13-3. Outdoor Unit

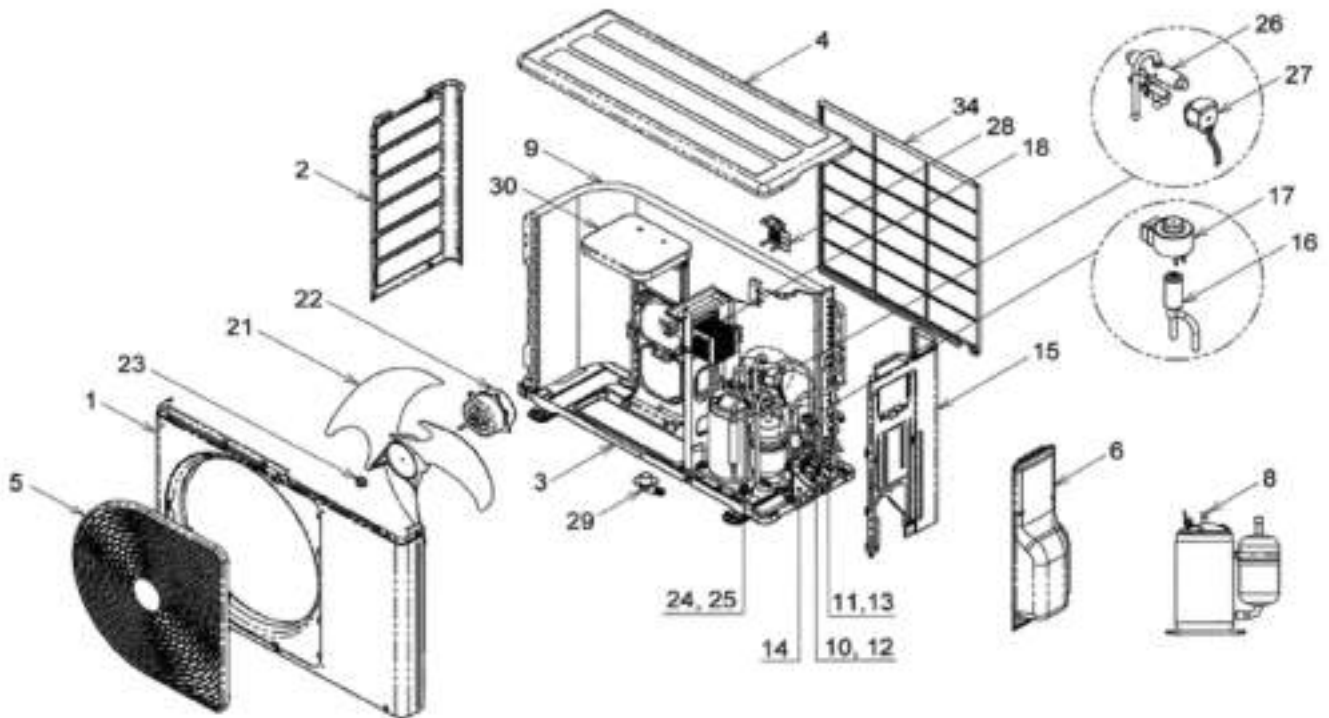

31 HOLDER SENSOR (TE) ; For PIPE OD 6.35 mm.
 32 HOLDER SENSOR (TD) ; For PIPE OD 8.00 mm.
 33 HOLDER SENSOR (TS) ; For PIPE OD 9.52 mm.

Location No.	Part No.	Description	Location No.	Part No.	Description
1	43T00468	FRONT CABINET	18	43T46351	REACTOR
2	43T00459	LEFT CABINET	21	43T20319	PROPELLER FAN
3	43T42327	BASE PLATE ASSEMBLY	22	43T21375	FAN MOTOR
4	43T00452	UPPER CABINET	23	43T47001	NUT FLANGE
5	43T19329	FAN GUARD	24	43T97001	NUT
6	43T00562	PACKED VALVE COVER ASSEMBLY	25	43T49335	RUBBER CUSHION
8	43T41420	COMPRESSOR	26	43T46343	4 WAY VALVE
9	43T43434	CONDENSER ASSEMBLY	27	43T63320	4 WAY VALVE COIL ASSEMBLY
10	43T46358	VALVE;PACKED 6.35 DIA	28	43T63319	HOLDER,SENSOR
11	43T46366	VALVE;PACKED 9.52 DIA	29	43T79305	DRAIN NIPPLE
12	43T47331	BONNET, 6.35 DIA	30	43T39333	MOTOR BASE CONNECTION PLATE
13	43T47332	BONNET, 9.52 DIA	31	43T63318	HOLDER SENSOR
14	43T00448	FIXING PLATE VALVE	32	43T63317	HOLDER,SENSOR
15	43T00451	RIGHT CABINET ASSEMBLY	33	43T63316	HOLDER,SENSOR
16	43T46347	BODY PMV	34	43T19331	FIN GUARD
17	43T63329	COIL PMV			

13-4. P.C. Board Layout

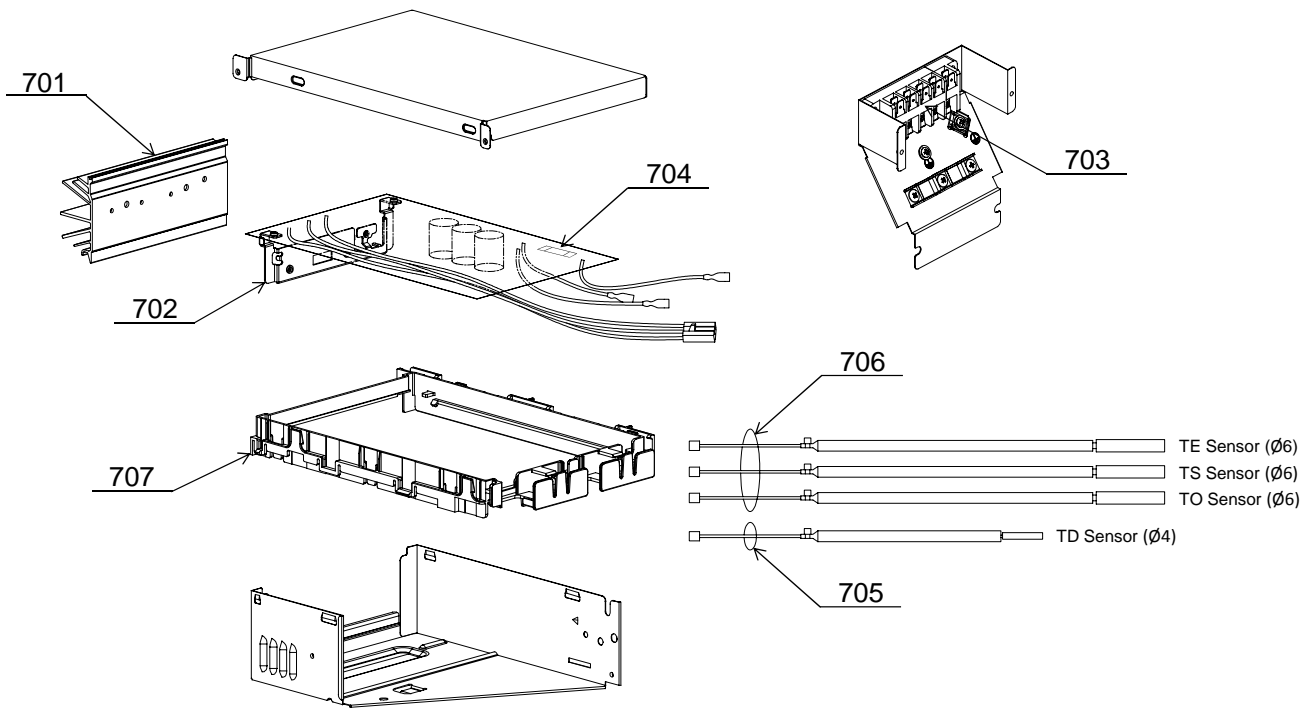

Location No.	Part No.	Description	Location No.	Part No.	Description
701	43T62320	HEATSINK	705	43T60377	TEMPERATURE SENSOR
702	43T69815	PC BOARD	706	43T50304	SENSOR; HEAT EXCHANGER
703	43T60392	TERMINAL-5P	707	43T62313	BASE-PLATE-PC
704	43T60326	FUSE			

TOSHIBA CARRIER (THAILAND) CO., LTD.

144/9 MOO 5, BANGKADI INDUSTRIAL PARK, TIVANON ROAD, TAMBOL BANGKADI,
AMPHUR MUANG, PATHUMTHANI 12000, THAILAND.